

**Factors Influencing Customer Satisfaction in Health  
care services: The Case of Public and Private  
Hospitals in North Cyprus**

**Catherine Efuteba**

Submitted to the  
Institute of Graduate Studies and Research  
in partial fulfilment of the requirements for the Degree of

Master  
of  
Business Administration

Eastern Mediterranean University  
August 2013  
Gazimağusa, North Cyprus

Approved by the Institute of graduate Studies and Research

---

Prof. Dr. Elvan Yilmaz  
Director

I certify that this thesis satisfies the requirements as a thesis for the degree of Master of Business Administration.

---

Assoc. Prof. Dr. Mustafa Tümer  
Chair , Department of Business Administration

We certify that we have read this thesis and that in our opinion it is fully adequate in scope and quality as a thesis for the degree of Master of Business Administration.

---

Assoc. Prof. Dr. Mustafa Tümer  
Supervisor

---

Examining Committee

1. Assoc. Prof. Dr. Mustafa Tumer

---

2. Prof. Dr. Cem Tanova

---

3. Asst. Prof. Dr. Ilhan Dalci

---

## **ABSTRACT**

This study is aimed to examine the important changing aspects that influence customers' satisfaction in Health Care institutions. The two models developed in this study investigate the factors influencing customers' satisfaction and also evaluate the services provided from both private and state hospital settings in the Turkish Republic of North Cyprus. Today, the service world is in pursuit of resources to invest on efficiency. Most governments focus on the public healthcare system since private healthcare providers are becoming the best alternatives for many patients who can afford them. Hospital preference and other factors that customers consider before deciding on choosing a health care provider are identified in this study to a certain degree. Moreover, several published research papers on medical and marketing management have incorporated the term "Satisfaction" over the past 25years. This has been replicated in the changes instigated in service management in most countries over the past decades.

A total of 300 hospital users from different ethnic origins and backgrounds, with differing cultural values and beliefs, including native Turkish Cypriots, responded to 60 questions in both English and Turkish Languages respectively, dealing with the current healthcare service situation in North Cyprus. The overall expectations from the respondents indicated that there is a positive-significant relationship between interpersonal bonds and satisfaction. Thus confirming that both the private and state hospitals should place more emphasis on improving the quality of services offered.

**Keywords:** Expected Service Quality, Customer Satisfaction, North Cyprus,  
Private and State Hospitals, Interpersonal Bonds

## ÖZ

Bu çalışma, sağlık merkezlerinde müşteri memnuniyetini etkileyen önemli faktörleri incelemektedir. Çalışmada müşteri memnuniyetini etkileyen iki model kullanılmış ve Kuzey Kıbrıs Türk Cumhuriyeti'ndeki özel ve devlet hastanelerinin sağladığı hizmeti değerlendirmektedir. Günümüzde hizmet sektörü verimli yatırım yapabileceği kaynak arayışı içindedir. Birçok devlet, kamu tarafından sağlanan sağlık hizmetlerini iyileştirme gayretindedir. Çalışmamızda, sağlık merkezi ve bu hizmeti sunacak kişiyi seçerken etken olan faktörler de tanımlanmıştır. Son 25 yıldaki tıbbi ve pazarlama yönetimiyle ilgili belli başlı makalelerde 'Memnuniyet' kavramı bulunmaktadır. Bu da son yıllarda birçok ülkede hizmet yönetimi kavramındaki değişiklikleri artırmıştır.

Farklı etnik köken, geçmiş, değer ve inançlardan olan 300 hastane kullanıcısı kendilerine yöneltilen 60 soruyu cevaplandırmışlardır. Sorular, Kuzey Kıbrıs Türk Cumhuriyetindeki sağlık hizmetlerinin şu anki durumunu düşünerek ve önce İngilizce daha sonra da Türkçe olarak hazırlanmıştır. Hastane kullanıcılarının beklentileri doğrultusunda, memnuniyet ve bireyler arası bağ (ilişki) arasında olumlu (pozitif) ve belirgin bir ilişki olduğu bulunmuştur. Bu da, hem özel hem de devlet hastanelerinin hizmet kalitelerini geliştirmeleri için bir çok etmene önem vermesi gerektiğini göstermektedir.

**Anahtar Kelimeler:** Hizmet Kalitesi, Müşteri Memnuniyeti, Kuzey Kıbrıs, Özel ve Devlet Hastaneleri, Bireylerarası Bağlar

Dedicated to my Beloved Family

# TABLE OF CONTENTS

ABSTRACT .....	iii
ÖZ.....	v
DEDICATION .....	vi
LIST OF TABLES.....	x
LIST OF FIGURES .....	xi
LIST OF SYMBOLS/ABBREVIATIONS .....	xii
1 INTRODUCTION .....	1
1.1 Health.....	1
1.2 Health Industry.....	2
1.3 Cost of Health care in Developing Economy.....	2
1.4 A Brief Review of North Cyprus .....	3
1.5 Healthcare Service in North Cyprus.....	4
1.6 Aims of this Study.....	5
1.7 Importance of this Study.....	6
1.8 Structure of this Study .....	6
2 LITERATURE REVIEW.....	8
2.1 The Service World.....	8
2.2 Service Characteristics.....	10

2.2.1 Intangibility .....	11
2.2.2. Inseparability .....	12
2.2.3 Heterogeneity .....	12
2.2.4 Perishability .....	13
2.3 Quality and Customer Satisfaction .....	13
2.4 Service Quality Instrument .....	14
2.4.1 Criticisms within Service Quality Dimensions .....	17
2.5 Patient Satisfaction and Outcomes .....	18
2.5.1 Background Knowledge of Patient Satisfaction .....	19
2.5.2 Major Contributing Factors of Patient Satisfaction .....	20
2.5.3 Satisfaction Components .....	22
2.6 Conceptual Model .....	25
2.6.1 Hypotheses .....	27
3 METHODOLOGY .....	33
3.1 Questionnaire Design .....	33
3.2 Sample and Data Collection .....	36
3.3 Findings .....	37
3.3.1 Descriptive Analysis of Demographic Results .....	37
4 ANALYSIS AND RESULTS .....	48
4.1 Descriptive Statistics .....	48



4.2 Reliability and Convergent and Discriminant validity Measurements.....	49
4.3 Structural Model(s) Results and Hypotheses Testing .....	55
4.4 Data Analysis and Description.....	59
4.5 Inital Path Model Analysis.....	63
5 DISCUSSIONS AND RECOMMENDATIONS .....	68
5.1 Conclusions .....	68
5.2 Employees Perspective .....	69
5.3 Implications.....	70
5.4. Limitation and Future research guidelines.....	70
REFERENCES .....	72
APPENDIX .....	86

## LIST OF TABLES

Table 1: Distribution of Respondents by City of Resident .....	40
Table 2: Distribution of Respondents by Monthly Income Level.....	44
Table 3: Statistical Analysis of State and Private Hospitals .....	46
Table 4: Description of the Reliability and Convergent Validity Scores .....	50
Table 5: Illustrates the Correlation Amongst Construct Scores .....	51
Table 6: Shows Factor Loadings of all Variables .....	52
Table 7: Shows the Standard Deviation and Mean of all Variables excluding Satisfaction .....	54
Table 8: Illustrates the Inner Structural Model (a) .....	57
Table 9: Description of Reliability and Convergent Validity Scores( Fig 2b) .....	60
Table 10: Correlation Amongst the Construct Scores including Satisfaction .....	60
Table 11: Illustrates the Mean and Standard Deviation of all the factors.....	61
Table 12: Description of Factor Loadings including Satisfaction.....	62

## LIST OF FIGURES

Figure 1: Describe Background knowledge of Patient Satisfaction .....	20
Figure 2(a): Model (a) Illustrates the Hypothesized Relationship among the Five Interpersonal Bonds and Loyalty.....	26
Figure 2(b): Model (b) Illustrates the Hypothesized Relationship Among the five Interpersonal Bonds alongside Satisfaction and Loyalty .....	27
Figure 3: Distribution of Respondents by Gender.....	37
Figure 4: Distribution of Respondents by Age.....	38
Figure 5: Distribution of Respondents by Nationality.....	39
Figure 6: Distribution of Respondents by Occupation .....	41
Figure 7: Distribution of Respondents by Marital Status .....	42
Figure 8: Distribution of the Educational Level of Respondents .....	43
Figure 9: Distribution of Respondents by Monthly Income levels .....	44
Figure 10: Illustrates Respondents' Preferences of Healthcare.....	45
Figure 11: Evaluation of Conceptual Model (a) excluding Satisfaction .....	58
Figure 12: Initial Path Model (b) Illustrates r-square, beta-values and Coefficients .....	65
Figure 13: Illustrates t- Statistics of all Variables .....	67

## LIST OF SYMBOLS/ABBREVIATIONS

TRNC.....	Turkish Republic of North Cyprus
PLS .....	Partial Least Square (software)
$\beta$ .....	Beta
H 1/2/3 .....	Hypothesis 1/2/3
ServQual.....	Service Quality

# Chapter 1

## INTRODUCTION

### 1.1 Health

The health and wellbeing of people has a long history in the development of environmental and social sciences as for example in sociology, geography and economy (Garner & Raudenbuch, 2012). The demand for healthcare services (is constantly on the rise) has increased recently (Schempf & Kaufman, 2011). Researchers still support the fact that the closer the distance to health care services the more accessibility (Hiscock, 2008).The World Health Organization (WHO) defines health as:

*“a state of complete physical, psychological and social well-being and not the absence of disease” (WHO, 1948,no.2 , p.100) .*

The concept of health is more interrelated, meaning it can also be defined using other dimensions and approaches (Nordenfelt, 1995) For instance, health in the marketing perspective broadly defines and seeks to meet persons who are healthy and also want to keep on being healthy. Health marketing is essential in many ways: It is global and competitive, societal in nature and overflowing with regulations (Berry & Bendapudi 2000).

Today’s health care marketing is inundated with systematized application of marketing principles within the heterogeneous and complex characteristics in the health care field.

This can be seen in several distinct fields of study by Berry & Bendapudi (2000); Lega,(2006); Stremersch,(2008).

## **1.2 Health Industry**

The uncompensated and discounted health care known and served as the medical safety net is gradually being squeezed out by other health sector competition because of the expansion of the profit making healthcare sector (Thorpe, 1997). Likewise, the health care industry does not operate like other markets because there is the risk of uncertainty, also heterogeneity of clients and the risk of disproportionate finances (Enthoven, 1980) .

Adequate access to a well-organized health care system within a country is very important for economic growth and development. A programmed healthcare system ensures service quality. However, many developed countries' healthcare systems have been facilitated by health insurance in order to deliver quality service. A good example is the case of the United States healthcare system that has structured its model towards health insurance to facilitate access to quality medical care. (Millman M. , 1993) .

## **1.3 Cost of Health care in a Developing Economy**

Today, customers respond rapidly to the rising costs of healthcare services because of limited health care coverage (Chollet,1996; Davis & D.Makuc 1981).Government health policies are focused on encouraging insurance coverage and also want to reduce financial and geographical barriers to health care. This sensitivity of cost treatment in a developing economy such as North Cyprus is visibly noticeable within a particular

segment of the population, were the rich utilize the best units of healthcare compared with the middle class and the poorer populations. As backed by the demographic response rate and preference of hospitals in this study, it has been noticed that those with an income level above 1000 dollars per month preferred to visit private hospitals or personal physicians working for private clinics when they are in need of any medical intervention, despite the subsidized low cost of health care services in Public hospitals.

#### **1.4 A Brief Review of North Cyprus**

Cyprus is one of several islands located in the Mediterranean Sea and it is the third largest of them all. Several researchers have addressed the eventful history of Cyprus dating back to 8500B.C from the time when settlers came to exploit the richness of copper and timber. Cyprus was and since 1974, as North Cyprus, still is a center for attraction because of its strategic location to many routes along different countries in the Mediterranean

North Cyprus gained independence from British rule in 1960. Today, the country is now known as the Turkish Republic of Northern Cyprus (TRNC), established on 15 November 1983. It covers a squared area of 3,355 kilometers bordering Turkey, Lebanon, Israel, Egypt and Syria. The official spoken language of TRNC is Turkish even though English is widely spoken as a second language. The official currency in TRNC is the New Turkish Lira which helps to link its economy to Turkey. The estimated population of TRNC as confirmed in 2011 was 294,906.

TRNC climatic conditions vary, with cool winter and rain, and with the occasional heavy storm. Summer is hot and dry followed by a short nearly unnoticeable autumn. The humidity of the Mediterranean Sea peaks up to temperatures of 40-46 °C. North Cyprus's economy is typically dominated by the service industry (Public sector, education, trade and most importantly, the tourism industry).

### **1.5 Healthcare Service in North Cyprus**

In general, the health service in North Cyprus is carried out by both public and private institutions. The hospitals are at par with international standards; with recent medical technology and competent personnel. According to the statistics reported by Arikian (2005) there are nine public hospitals with a total of 626 beds (67.9%) and fifty-two private hospitals in TRNC. As for the financial aspect, prices of medications and quality of health care services will depend on a persons' preference of healthcare, which implies that cost might differ accordingly. The central/public hospital is found in the Capital city of Nicosia. There are many other smaller public and private hospitals/Clinics in other cities in North Cyprus namely; Kyrenia, Guzelyurt, Famagusta and Lefke. Similarly, clinics can also be found in smaller towns and villages where medical treatment is almost free.

Today, private health care providers play a vital role in North Cyprus' overall health sector growth. The service industries share in health, tourism, education, and many more adding up to 66.3% of the world (GDP) in 2000. Healthcare GNP equated to 9.3% (World Development Indicators, 2003), as evidenced by the recent growth projection in



the private health sectors. These growth trends indicate that there is an immense competition in North Cyprus's health care industry, as is the case with many other nations as a whole. However, this existing competition comes directly from the public healthcare providers including other emergent enterprises. Bhatta (2001) supports the above statement, confirming that private healthcare businesses are perceived as delivering healthcare in a more efficient and robust manner compared with Public hospitals.

### **1.6 Aims of this Study**

The aim of this study is to investigate the factors that influence customer/Patient satisfaction. This study examines and investigates the interpersonal connections with other factors that would influence quality healthcare delivery to customers. (By using service quality measurements and the five interpersonal bonds (Gremler D. 2000).Customer satisfaction in healthcare service is a foundation that enhances growth and also ensures patient loyalty in the long run. (kirshnan, 1998).

This study is aimed at determining what factors affect patients' preferences when choosing one hospital over another, as well as what factors minimize cost variances. Also, this study will proceed to investigate and compare the quality of healthcare services amongst privately owned and state owned hospitals from the viewpoint of Turkish Cypriots and other nationalities .Furthermore, this study will examine the levels of customer satisfaction as most managers place more emphasis on the importance

(Reichheld & Teal, 1996) of increasing customer loyalty for long term growth benefits (Anderson & Lehmann, 1994).

### **1.7 Importance of this Study**

Health is wealth, so measuring patients' satisfaction and the factors that influence service delivery is very essential to North Cyprus Economy. At the same time identifying and acknowledging the health care service that is most significant to the North Cyprus population.

The results from this study will help managers, administrators and business owners in North Cyprus and other parts of the world to develop more adaptable and suitable policies to easily integrate and to generate quality healthcare within private and state owned sectors. Moreover, because of the lack of research conducted in this field within the Middle East, Asia and Africa respectively, this study aims to make some significant contributions that will go a long way towards improving the quality of healthcare, customer satisfaction and loyalty, thus improving not only economic growth and development but also health tourism.

### **1.8 Structure of this Study**

The study is structured to examine the dynamics of health care delivery services. Hence, it will go a long way towards investigating some selected factors that influence patient satisfaction. An extensive study on healthcare and service providers will be reviewed from several research findings to prepare a comprehensive background.

This study also develops some selected determinants of service quality in North Cyprus hospitals. (A random selection of 300 respondents) who had recently experienced healthcare services in North Cyprus answered a modified version of expected Service Quality (ServQual) scale containing 52 and 8 demographic questions in English and Turkish languages respectively. A total of 510 questionnaires were printed and distributed to respondents in schools, hospitals, offices and homes. A total of 430 answered questionnaires were obtained. However, out of the 430 only 300 responded questionnaires were appropriately completed with a resultant response rate of 86.7%, which was deemed as an acceptable level for this study.

## **Chapter 2**

### **REVIEW OF LITERATURE**

This chapter reviews the service industry in general and presents a brief history of North Cyprus' healthcare industry alongside the characteristics and needs for service improvement. It also discusses the effects and factors that determine satisfaction, both from the patient and the personnel perspectives.

#### **2.1 The Service World**

The service industry differs greatly especially among nations. For instance, the government delivers services through hospitals, courts, police and fire departments, postal services, employment services and schools (Kotler 2005). The service world expectations are well defined by service marketers as “meeting or exceeding customer expectations (Kong, 1996, p. 6). Service managers have to manage these expectations in order to satisfy clients (Peters, 1988). Customers that share the same values and expectations might be of help by offering possible market segmentation strategies as suggested by Jeantrout, (1994). In order to improve the Service industry, marketers can match these two core concept namely; service quality and customer satisfaction to market theory and practice (Mackoy, 2011). Today, there is an intense competition in the service industry and it is generally believed that the strategy to maintain a competitive advantage lies in delivering continuous high quality services to customers.

The Service industry can be classified as equipment -based service firms, also known as institutional markets which consist of hospitals, nursing homes, schools and many more (Kotler P. , 2005). These firms sole purpose is to deliver quality service to consumers. A good example is the dry cleaning service industry. Another classification of the service industry is people-based service firms, where services do not rely only on equipment but involve a more professional and educational background somewhat similar to equipment-based firms, such as accounting, medical, law and management consulting firms. According to a report confirmed by the U.S Bureau of labor statistics, employment is expected to shift exponentially towards the service industry, in fact 20.8 million new service jobs were created within 2002 and 2012. A vast majority of new service industry jobs came from education and health care sectors respectively.

Service is described by Bowen and Chen (2001) as a performance of activities; meaning a process of meeting clients, reporting, recording their data and communicating these activities through a series of performances. The service industry category include tourism, health, banking, tertiary institutions, legal services and a lot of others .It can be intangibility, inseparability, perishability and heterogeneity in nature (Bitner M.J., 1998). This implies that the gateway to customer satisfaction is provided through the delivery of quality services (Parasuraman., 1985). Behind the complexity of the service world lies the concept of productivity.

Many researchers like Adam Smith argued that service is unproductive and does not accumulate wealth. On the other hand John Stuart Mills simply acknowledged that some services add to the growth of the economy. However, back in the twentieth century

researchers agreed that all services were productive. According to their judgment any paid worker was deemed productive, while the housewife for example, was deemed unproductive in the service world (Nacy Folbre., 2003). With regards to the above discussion, one can distinguish health care services from among other services in particular, due to its complexity and the risky nature attached to it.

Phillip Kotler (2003), discussed some relevant statistical data in his book, “Marketing Management” on service sectors which includes: Services provided by the U.S economy accounts for a 76 % growth in GDP. The aforementioned statistic reveals that the service economy is growing constantly as technological changes continue to develop. Heizer and Render (1999); Jay H.Heizer, (2006), describe the service world as, ‘those activities that are specialized in producing tangible products’. While Kotler (2003), claims that service is an essential, intangible assistance that can be given or offered to an individual and not a possession.

## **2.2 Service Characteristics**

Most academics deliberate on the difference between goods and services from the view point of intangibility in proportion to the physical product, the tangibles (Locelock.J.E.. & Roger.WSchmenner, 1992). Equally, few writers like Rust and Oliver (1994) consider tangible and intangible service settings as the only characteristics of service quality instruments. Normann (2000), interestingly termed service settings as the ‘moment of truths’ (MOTs). However, there are some common characteristics of services that differentiate them from product characteristics (Keizer & Render 2007; Bergman, 1994).

Service sector economy is described by Lovelock C. (1996) as almost going through “revolutionary proportions” since the established ways of operating a business continues to be shoved aside. Service sector has a diverse characteristic which ranges from small businesses to larger organizations like hospital, banks, transport, insurance, telecommunication, universities and hotels to locally owned businesses like delivery service companies, (dentists, diet, optometrist, obstetrics) clinics, diagnostic laboratories, pharmacies, restaurants, repair shops, malls and many more (Lovelock, 1996).

Many attempts have been made by Gronroos (1983) towards defining service quality in terms of “what is done” and “how it is done”. While other researchers like Zeithaml (1988), describes service quality as a customer’s overall evaluation of distinct excellence. The judgment stated above greatly depends on an individual’s perception. Parasuraman *et al* (1985) supports the above statement by defining service quality as the difference between predicted customer perceptions and expectations from the service outcome. Also, He detailed that services have four key characteristics namely: intangibility, inseparability, heterogeneity and perishability which are important considerations when measuring service quality especially in the health care sector.

### **2.2.1 Intangibility**

Services are termed intangible when they cannot be felt, tasted or seen. A good example comes from the services a hospital offers to its patients. These services cannot be touched by the patient as can be evidenced when comparing goods and services. Services cannot be accounted as inventory and it is difficult to manage (Zeithaml &

Dwanye, 2006), but goods can. Service market managers should try to “tangibilize” their services. For instance, by making it less difficult to communicate to customers (Zeithaml & Mary, 2000).

### **2.2.2 Inseparability**

The word separable means able to be separated or to be treated apart and inseparable means unable to be treated apart. It can be used to distinguish between objects or boundaries just as Lovelock.. & Christopher ( 1991), stated that the concept of inseparability involved individuals as part of the product. This means there is a simultaneous interaction in most services produced and consumed. For example, in some cases, services are to be paid for first by the customer before it is delivered and consumed at the same time. However, consumers should be present and even partake during service delivery. A surgeon can perform a surgical procedure when fees are paid and the patient is present throughout the operation. This link has to be established in order for a patient to share expected views with the service provider. In the case of an interruption, where the patient never meets the surgeon and there is no shared view, the service quality and customer satisfaction will highly depend on what happens during the healing process. (Lovelock.. & Christopher, 1991)

### **2.2.3 Heterogeneity**

There are no two patients who share the same expected view, experience and preferences. Human beings are diverse in character, implying that there are no two services perceived as exactly alike. People have different tastes at different times .Managers face a lot of challenges to satisfy just one client. Also the needs of a patient



differ when it come to gender, bodyweight, illness, social class and values. Zeithaml Valerie & Dwanye (2006), gave another reason for heterogeneity as a characteristic of service which supports the assumption that customers are distinct in their demands and ways.

#### **2.2.4 Perishability**

Services cannot be stored, resold or returned to the provider, but goods can be. A nurse cannot take back the services already delivered from the patient. Neither can a doctor resell or return the procedure to another patient (Zeithaml, 2006).The above characteristic implies that the health service market is very different and challenging from other service industry markets.

### **2.3 Quality and Customer Satisfaction**

The only way a private healthcare provider can better align to the ever demanding customers and retain them is to exceed customer's expectations by constantly measuring their expectations and perceptions. A customer service quality expectation has an unquestionable effect on the preference of a health care provider. Quality also comes with the ability to heal alongside the customer's best interests which include the lowest cost (Ramsaran-Fowdar, 2005).

The relationship between service quality and customer satisfaction is reciprocal (Mnagold & Parasuraman et al., 2010) .Customers find it difficult to measure technical quality in health Care, since ServQual may be measured using a more technical approach ,thus making it difficult for patients to relate to and understand. At this point,

patients can only share, understand and even measure a laboratory technician's personal hygiene and the surrounding cleanliness of a place. This is because customers are better placed to understand functional quality rather than technical quality (Aksarayli, 2010).

Service quality may lead to customer satisfaction (Antreas, 2010). The history of servqual measurements go back a long way and has been criticized by Drew (2004) on the use of the gap scores. However, in spite of this criticism, several studies have continued to use ServQual to measure the quality of care delivered to customers (Headley, 1993).

#### **2.4. Service Quality Instrument**

The service quality instrument is widely used in many service industries today, such as hotels, hospitals, universities, transport agencies and many more (Foster,1995). Most research work on health care servqual is based on the servqual instruments, even though several other models assessing health care have been proposed .Coulter (1991) claimed that there are four areas which need to be considered when assessing the health care environment:

- Assess the pattern of care for specific patient groups.
- Assess the treatment procedure, for example, surgical procedures.
- Assess the institutions or the organizations as a whole.
- Assess the health care system.

The above mentioned areas are considered to be important in many studies related to Customer satisfaction (Cochrane,1997). Cochrane, also summarized three principles which could be used to assess medical procedures, such as the effectiveness of the procedure, equality, and efficiency. Social acceptability was later proposed in addition to the above three by Sitzia and Wood (1997).

Parasuraman, Zeithaml and Berry (1985), recommended ten dimensions to perceived ServQual namely; tangibility, responsiveness, competence, courtesy, credibility, access, security, communication reliability and the preparedness to listen to customer complaints (Boshoff. & Gray., 2004). However, it was later classified by Parasuraman *et al* (1998), into five dimensions used by several service industries particularly healthcare providers, to evaluate their standards ( Carmam, Lam, & sheikh, 2006). These five dimensions considered were as follows:

*Tangibility*: this refers to the physical appearance of the personnel, equipment and facilities.

Hospitals or clinics with good infrastructures, neat personnel and equipment visually appeals and attracts lots of customers. This simply creates a positive impact and signals quality to patients, thus encourages them to visit such hospital environments for treatment.

*Reliability*: this is the ability to perform promised services and duties proficiently to customers.

This dimension is very significant to hospitals that need to evaluate their overall service quality level. For instance, when hospital schedules are reliable, especially in problem solving, time, date, recording data, and the fulfilment of an agreement, customers tend to trust the health provider.

*Responsiveness:* this is the willingness to provide prompt and helpful services to customers.

Many patients are dissatisfied when they have to wait hours for treatment or consultation. Hospitals should place more emphasis on promptness and communicate important treatment plans ahead of time in order to satisfy customers. Dealing with client complaints and requests is another issue, and hospital personnel should be trained to tackle them easily and readily.

*Assurance:* the knowledge and courtesy of the health care provider to be able to convey trust and confidence.

“Health is wealth” no one can afford to risk it. Patients/customers with uncertainty about the service quality have little or no confidence in the healthcare provider. This seeps into the feelings of doubt about the diagnosis or even the treatment. Health care providers should endeavor to courteously convey constant trust to the customers.

*Empathy:* This is the ability to provide individualized care and attention to customers.

Generally, a good customer/employee relationship can be established when the employee understands the personal needs and values of the customer. The attention paid

to the customer and the uniqueness in the manner in which this is addressed can build trust, empathy, and satisfaction between the customer and the service provider.

#### **2.4.1 Criticisms within Service Quality Dimensions**

A significant number of studies recently have used the servqual model as a measuring framework. Despite the criticisms in both theoretical and operational aspects of the ServQual model. Marketing research literature by Babakus,1992; Newman, 2001; Smith, (1995), have exchanged different ideas as well as criticisms in the interpretation and implementation process of the ServQual framework, thus making the five dimensions of ServQual questionable (Carman, 1990; Cronin 1992).However, there is no standard measurement or scale to account for ServQual, even though it is difficult to measure. It is still widely used simply because it is more adaptable and appropriate in terms of different organizational settings and also provides a backbone for many research models (Parasuraman A., 1988). Buttle (1996), concurred and stated that ServQual measurement is still very valuable and the most widely used and appears to be the best existing model as compared with others. While Angur, (1999) also added that ServQual measurement significantly supports leaders in addressing complex problem areas especially during service management crisis.

## **2.5 Patient Satisfaction and Outcomes**

Satisfaction is a person's feelings of perceived performance and expectations. If a hospital performance falls below expectations, the patient becomes dissatisfied. Likewise, if the services performed matches or exceeds expectations the patient is satisfied. Most companies today are focused on truly satisfying their clients, and the reason being that just-satisfied clients are prone to switch when they find better options (Kotler P. , 2000a). Patients that are highly satisfied always create personal connections with their health care providers. Kotler P. , (2000b) clearly stated that managers need to focus on setting the right level of customer service expectations in order to develop and manage interpersonal bonds (Kotler P. , 2005 ) Patients will evaluate a service as satisfying when it is useful, effective and beneficial (Coutler.A., 2003). Satisfaction is a very complex concept. It is multi-dimensional and difficult to measure (Kotler P., 2005) because at this juncture the product is an idea and not an object.

However, patient's judgments are significant indicators of the quality of care, accuracy of diagnoses and the effectiveness of treatment (Epstein AM, 2004). When satisfaction is measured, changes can be very essential to make the service delivery process impeccable. Thus identifying the needs and wants of customers can create dazzling offers, stimulate minds and develop familiarity (Rasmusson, 2000 & Lawrence, 2004).The outcome from highly satisfied customer is loyalty (Kotler P. , 2000c) .

### **2.5.1 Background Knowledge of Patient Satisfaction**

In many countries today, the healthcare management sector, places a lot of emphasis on patient satisfaction. Evidence can be found from the frequency of observed recent academic publications related to satisfaction.. For instance, Donabedian, (2005) claims that quality care can be attained by generating satisfaction. Furthermore, surveys about patient satisfaction have used some data as dependent variables to evaluate servqual on the assumption that patient satisfaction depends on the structure, process and outcome of care available at the time of delivery. Ware Je Jr, (2009), defined patient satisfaction as those contributing factors and components that generate satisfaction. See Figure 1 below:

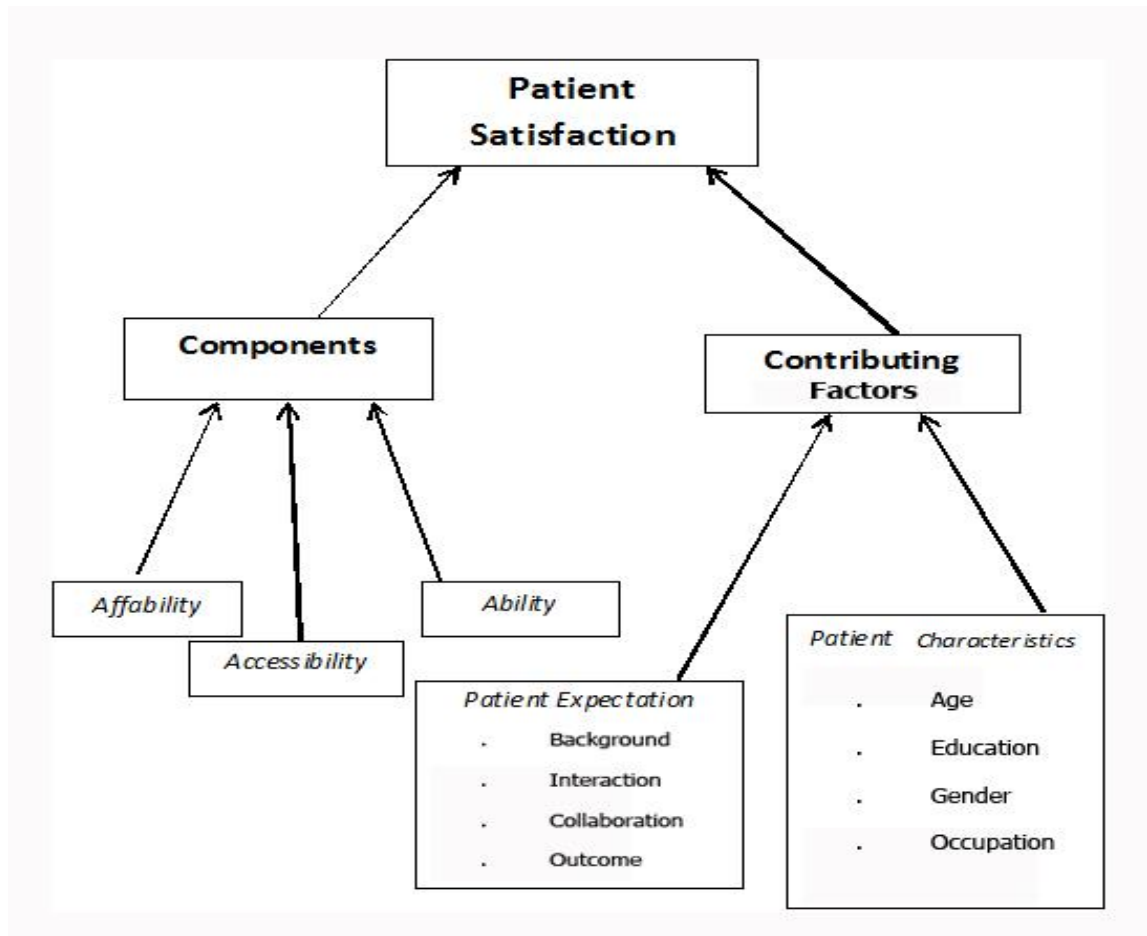

Figure 1: Describes the background knowledge of Patient Satisfaction

### 2.5.2 Major Contributing Factors of Patient Satisfaction

These contributing factors were identified from an in depth content analysis of items in questionnaires from many published literature reviews from several distinct populations. A patient's expectation about a healthcare provider can greatly influence perception and the level of satisfaction (Abramowitz, 2009). There are eight well-known dimensions which create the foundation of satisfaction and dissatisfaction; Such as , 'Care'; the art of care, technical quality of care, accessibility, convenience, financial and the, physical



environment, continuity care and finally, the outcome of care. In addition, Stimson & Webb, (2009) allocated three categories of patients' expectations as explained below as follows: Background, Interaction, Collaboration and Outcome.

*Background expectations* are constructs built upon previous experiences and interactions between the doctor and patient during the phases of consultation and treatment.

*Interaction Expectations* explains how a patient would like to interact with other members of the health care team, for example the method of investigation.

*Collaboration expectations* refer to the referral procedure from one specialist to another and also how medications are prescribed to the patient.

*Outcome expectations* depend on the end result of care services, and whether or not it equals patient's needs and wants. An example would be that of a patient after a complex surgery; in this case, patient satisfaction is subjected to a gradual symptomatic relief outcome. (Lee J, 2009).

Moreover, patients' expectations and satisfaction related causal factors certainly determine the characteristics of patients themselves. One of the most socio-demographic factors of patient satisfaction is *Age*. Blanchard CG. & JC.,(2009) stated the fact that younger generations tends to be less satisfied than the older generation, which explains why the old easily comply to treatment and demand less from their physicians as compared to the young.

Another demographic factor is the *educational level* which correlated to satisfaction as mentioned by Hall JA., (1990). Similarly, *gender, occupation, cultural origin and Income level* also play an essential part in determining satisfaction levels (Hall JA., 1990).

### **2.5.3 Satisfaction Components**

Ware Jr (2009), and Fitzpatrick, (2009), categorized satisfaction modules into seven elements which closely reflect the most common components associated with satisfaction. These seven elements are outlined and explained below as follows: Permanence of care, outcomes of care, technical quality of care, accessibility, convenience, and the physical environment of care, financial aspect and the availability of care. Also these above mentioned elements are broadly summarized in the three A's to fit the health care context discussion as follows: Affability, Accessibility, and Ability (see Fig.1).

#### **Permanence of Care/Affability**

This is related to the degree of Care made known to a patient. It is actually one of the values a health provider should reveal. When care becomes reliable, it contributes greatly to patient satisfaction (Rotter, 1975). Still on the positive end of this dimension, a health care provider should place more emphasis on the consideration of responsiveness and genuineness in order to deliver quality service. And finally is the art of care which measures the magnitude of the health care provider's rapport (Rotter, 1975).

### **Efficacy/Outcomes of Care**

Efficacy, or in other words ‘locus of control’ (Rotter, 1975) is the usefulness of a health provider to develop and sustain health statuses. This is an advantageous indicator for the healthcare provider.

### **Technical Quality of care/Ability**

The technical quality component of care is related to the providers conduct, competence and devotion to the high standards of diagnosis and treatment. Elements assessing a patient’s perception or expectation as regards to technical quality depend on the work experience of the healthcare provider.(Fitzpatrick, (2009),(1984).On the other hand, technical malpractice can be a great deterrent because of faulty machinery and poor facilities, wrong prescriptions and procedures (Rotter, 1975).

### **Accessibility**

Accessibility is the term used to denote the level of convenience involved in the arrangement and delivery of health care services .North Cyprus is still a growing economy and needs to place more emphasis on the accessibility to health care services. The focus of health care should be placed on the older population, the numbers of which are gradually increasing. Another facet of health care to take into consideration would be whether healthcare can be obtained from home, the time and the effort required delivering healthcare services (Abramowitz, 2009). Indeed, there are some evolving concerns over access to healthcare in terms of the present trends. This is as a result of responding to an increased level of the costs of healthcare, thus customers tend to limit coverage or switch to other forms of health care delivery services that they can

afford. (Davis & Chollet 1996).The new era on health policy encourages insurance coverage and newly-established healthcare providers in order to limit the geographical and financial barriers to health care delivery system (Grumbach & Bindman., 1997) most especially the vulnerable population.

#### **Convenience of location/Accessibility**

Location is another area of focus to be studied, as well as the convenience of hours during which care can be obtained and the waiting time before care is received. Most health care providers that consider these dimensions during the service delivery process, easily out-grow competitors and attract more customers (Abramowitz, 2009).

#### **Physical environment of care/ Accessibility**

The foundation of satisfaction begins with the physical environment where health care services are being delivered. It should include a pleasant atmosphere, comfortable beds and seats for the out-patient rooms, simplicity of signs and directions, friendliness, neatness of the staff, orderly display of equipment/facility, good lighting, clean and quiet rooms (Rotter, 1975).

#### **Financial Aspect**

This is the *ability* to have quality medical care when needed without being set back financially (Marquis, Davies & Ware 1983). It is an important aspect in the reception of care. The flexibility of payment mechanism for instance; the acceptance of payments using credit cards, insurance coverage and the arrangements of delayed payments should be considered in order to satisfy patients.

#### **Availability of Health Care/Ability**

A study published by Ware & Snyder (1983) indicated important measurement scales in terms of availability and health care delivery in order to improve service quality. The *table 3* shows some selected North Cyprus Public\*\* and Private\* hospital statistics assessing the number of physicians, nurses and other auxiliary staff as compared to the rate of patient visits. The study findings indicated that patient were more dissatisfied with services provided by public hospitals in North Cyprus in general than services provided by private hospitals (Agdelen, 2007).

### **Importance of Measuring Patient Satisfaction**

Understanding customer satisfaction is essential at every level within an organization. Achieving satisfaction is worthy in itself even though difficult to accomplish. Measuring patient satisfaction easily relates to a change in practice to improve the quality of care provided. It also generates more compliance to care. Measuring satisfaction in hospitals is beneficial for the economy of many countries.

## **2.6 Conceptual Model**

The conceptual model of this study put forward some five important factors (interpersonal bonds) which contribute to improve customer satisfaction and Loyalty. As seen in Figure 2a and 2b of this study, the Constructs in model 2a proposes that, the five interpersonal bonds as referred to by (Gremler & Brown, 2001) namely; care, friendship, rapport, familiarity and trust, are contributing factors to Loyalty intentions. Whereas model \*2b simply suggests that the five interpersonal bonds, also contribute to Customer

satisfaction, thus encourages Loyalty (Wirtz, 2003). Details of the constructs models with each hypothesized relationships are confirmed below.

Model A

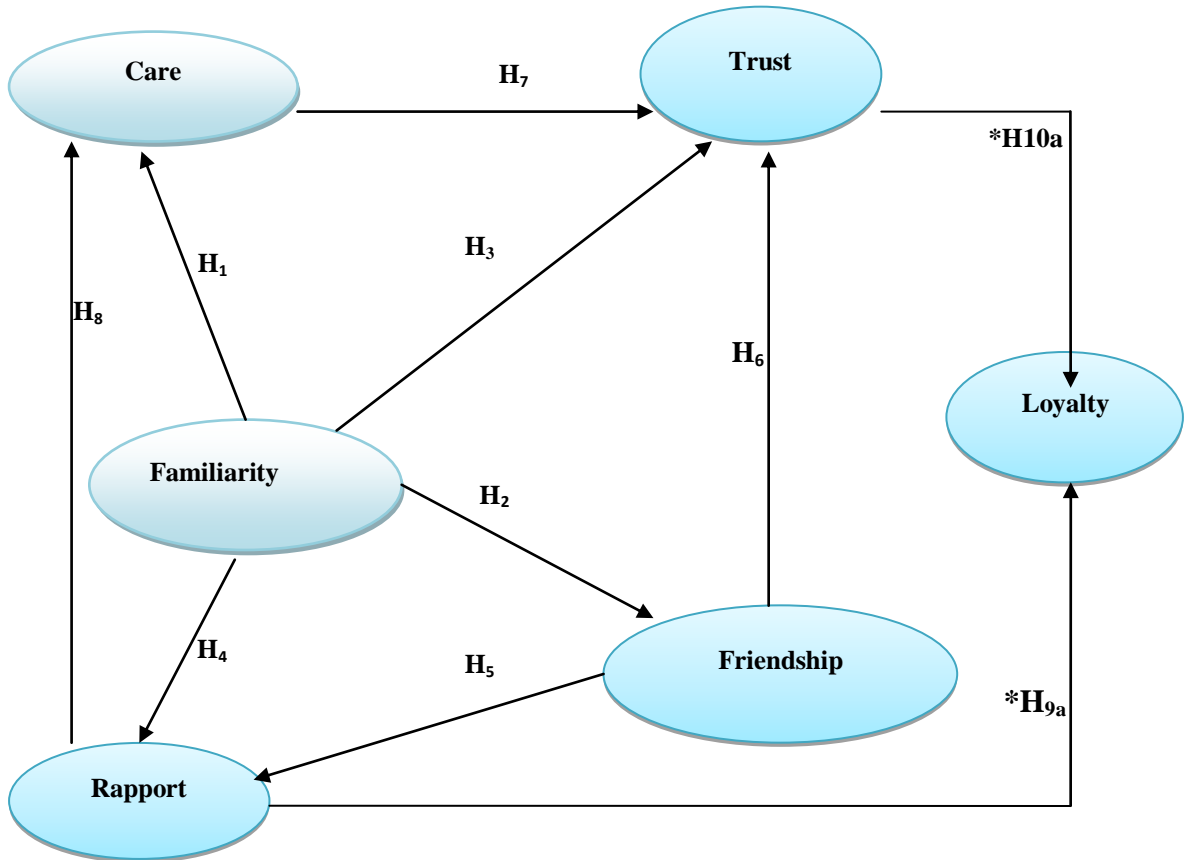

Figure 2a: Model (a) Illustrates the Hypothesized Relationship amongst Five Interpersonal Bonds and Loyalty

## Model B

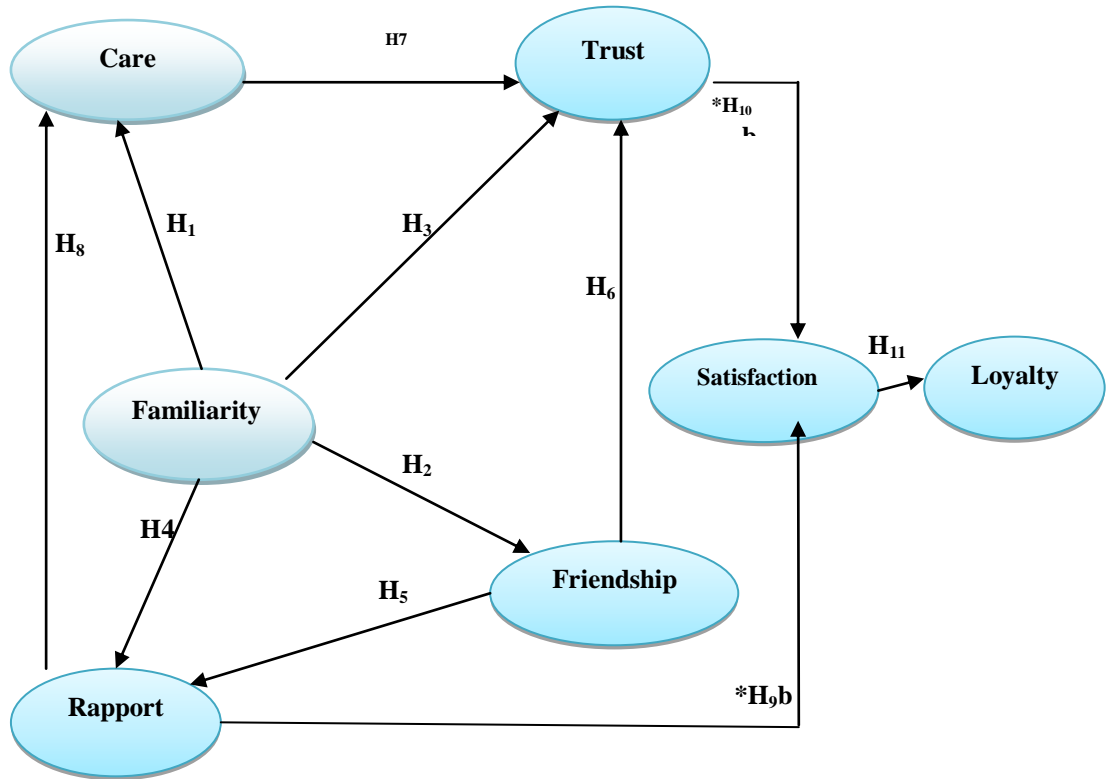

Figure 2b: Model (b) Illustrates the Hypothesized Relationship Among Five Interpersonal Bonds with Satisfaction and Loyalty

### 2.6.1 Hypotheses

#### *Familiarity*

Familiarity is defined as the customers' perspective in terms of 'how well a service provider recognizes each customer's needs and wants'. Familiarity can be influenced by the degree of communication and collaboration between service provider and customers. Many researchers have proposed that personal information about each customer can be used to create a sense of connection when providing healthcare services (Gutek, 1999; Gremler D. a., 2000 ). Hence Service providers need to associate and know customers'

personal information in order to deliver appropriate health care to them (van der Sande, 2000) . Familiarity can be established after a certain number of meetings between the healthcare staff and the customer. This relationship between customers and service providers generates a sense of confidence.

*H1: Familiarity positively affects customers' perceptions of care.*

According to Gremler and Brown (2001a), familiarity relates positively with personal connections. Although it is not sufficient to establish personal connections unless the service provider is also ready to share his/her own information. Therefore, a mutual self-disclosure will surge reciprocal actions, thus strengthen the bond of friendship between two individuals (Macintosh, (2002a). The presence of homogeneity shared between Service providers and customers may establish a common ground for personal connections .Hence, we posit that familiarity has a positive relationship with friendship development between service providers and customers.

*H2: Familiarity positively affects the establishment of friendship among Healthcare providers and patients.*

Basically, Familiarity develops ones ability to deliver expected services. It is understood that, Familiarity improves the judgement of one's competence and expectations. Several research findings concerning the foundation of Familiarity has proven that it is positively related to trust (Gremler & Brown, 2001a). Further suggestions from Gremler and Brown (2001b) confirm that Familiarity is an antecedent of a trusting relationship. In addition , Macintosh,(2002a), simply denotes that trust is more on the side of a predictive signal than an actual experience.



*H3: Familiarity positively affects customer's perceptions of trust.*

In addition to familiarity and personal connections is the characteristic of rapport. Unfortunately, many marketing reviews lack a good background knowledge of the constructs of rapport. Evidence has shown the worth of developing rapport with prospective customers (Busch & David, 1976, Stephen B. Castleberry, 1992). Rapport is a feeling of care and friendliness which occurs when there is communication between two people (Tickle-Degnen & Robert, 1990). That is, according to Gremler D. a., (2000) who delineates rapport as: an enjoyable personal connection between two people (service provider and customer). Which explains the driven force between familiarity and rapport (Gremler & Brown, 2001a). Rapport also enhances interactions between health care providers and patients when communicational boundaries are placed-aside (Jacobs, 2001). Macintosh (2009a) proposed that Familiarity plays an important role in building Patient/Customer rapport. Therefore rapport to some extent facilitates Familiarity (Gremler D. K., 2002) . Hence the following findings above posit that Familiarity has a positive relationship with rapport.

*H4: Familiarity positively influences rapport between healthcare providers and Patients.*

### *Friendship*

Research has confirmed that a reciprocal action plays an important role in the development of friendship (Crosby & Cowles, 1990). Most customers think of service providers as their friends (Price, 1999). Such feelings of friendship can be noticed between health care providers and patients who meet almost frequently within a short time interval (Caldow, 2000). The process of developing friendship between service

provider and customer may only be enhanced by the rapport both share, and thus the proposition of the next hypothesis is as follows:

*H5:* Friendship between a health care provider and patient has a positive impact on rapport.

The trust between a service provider and patient can exist if both share mutual understanding to some extent. (Gremler & Brown, (2001a).Some researchers found that customer expectations about service quality indicate a degree of customer's trust. Rapport and familiarity is positively related to Trust, therefore, this generates personal connections (Gremler & Brown, 2001a).

*H6:* Friendship between healthcare provider and patient positively affects patient's trust.

### *Care*

The intangible nature of service indicates some caution when dealing with customers. The manner in which service providers deliver care is important for the development of customer trust (Gremler D. D., 2008).

*H7:* Caring capabilities of a health care provider positively influence patient's trust.

### *Rapport*

Rapport is a positive sentiment from care and friendliness (Tickle-Degnen & Robert, 1990), while Gremler D(2000) believed rapport is a personal connection (with the chemistry of care and friendliness enjoyed). Rapport is seen as a key element accountable for patient care (Trojan & Yonge, 1993).

*H8:* Caring capabilities of a health care provider positively influence patient's rapport.

Rapport indicates an individual's 'in sync' (common ground) with another party. Several studies on rapport have developed more knowledge around interpersonal communication, most especially in the service sector. (Macintosh, (2002a);Gremler D. a., (2000). Rapport is important in the development of a lasting and trusting relationship (Nancarrow & Penn, 1998) In addition to the degree of rapport shared between service provider and customer, satisfaction and loyalty seemed to be the backbone to some extent. (Gremler D. a., 2000). Thus the following Hypotheses are proposed ( see figure 2 a,b).

\**H9a*: Rapport positively influences customer's loyalty.

\**H9b*: Rapport positively influences customer satisfaction.

### *Trust*

Most often, individuals tend to trust without doing so, consciously. People think they are independent , but we all rely on other people(s) object(s) or an organization to assist us achieve and keep those things in life that are valued the most (Pask E., 1995). Trust, in other words, as referred to Oxford Dictionary is reliability, strength, confidence and responsibility. From the customers perspective, trust is a key component in the nurse/doctor – patient relationship (Wallston k., 1997), and also a requirement for patient loyalty (Gilbert T., 1995) . The ability to enhance a trusting relationship is essential to patients (Thorne S; Rodgers B.,1989). Trust should be understood as a significant element that improves patient/customer expectations of care alongside with satisfaction (Trojan L. & Yonge O., 1993b), although it takes a while to establish (Pask E., 1994). Therefore, the following hypotheses (see fig 2 a,b) are proposed:

*\*H10a:* Trust has a positive impact on customer loyalty.

*\*H10b:* Trust has a positive impact on customer Satisfaction.

### *Customer Satisfaction and Loyalty*

Satisfaction can indeed be accepted as a condition for patient loyalty. As confirmed by several marketing literature reviews, 'satisfied customers obviously breed loyal customers'. (Anderson & Claes, 1994) ,which implies that satisfaction is the route to customer loyalty. Meanwhile, other researchers debate that satisfaction is not enough to generate loyalty (Reichheld F. 1993 & MacMillan 1992). Although interpersonal relationships are dynamic, it is more applicable at the personal level than at the organisational level and thus posits that patient satisfaction generates loyalty intentions (see fig. 2b).

*H11:* Patient satisfaction positively influences patient loyalty.

## Chapter 3

### METHODOLOGY

#### 3.1 Questionnaire Design

The survey method used to collect data was a well-designed questionnaire. In general, there were 60 simple straight-forward questions, divided into five sections. The very first section of the questionnaire was a single question designed to check the best source of healthcare an individual would prefer in case of any personal injury needing medical intervention. The next section included the five dimensions of service quality as distinguished as follows:

R1 – R4 Reliability

Rs1- Rs3 Responsiveness

T1- T6 Tangibility

A1-A3 Assurance

E1-E4 Empathy

The questions under the five dimensions for the measurement of service quality were carefully adapted to extract the best information based on the current state of health care in North Cyprus. Twenty questions related to the expected service levels were developed for this research using the work of (Peng & Wang,(2006); Parasuraman A. L., (1993).

The third section is related to the overall expected service satisfaction levels. Considering the healthcare situation in North Cyprus, this section of the questionnaire was very sensitive and complex to develop because it determined the repurchase intention of the patients and also the power of recommending the hospital to others. Twenty seven (27) questions with different variables were adapted and developed by using samples from other writers as seen below, to evaluate customers expectations about the quality of service offered namely:

Tr1-Tr3 Trust (Chu (2009))

St1-St4 Satisfaction (Oliver (1997))

L1-L4 Loyalty (Zeithaml, Berry and Parasuraman (1996) (Aydin & Ozer(2005))

F1- F5 Familiarity (Gremler et al. (2001))

Rp1-Rp5 Rapport (Gremler and Gwinner (2000))

Fs1-Fs6 Friendship (Gremler and Gwinner (2000))

The questions from the aforementioned formed the backbone of this research. Attributions of this section were a modified version of the ServQual instrument. The following factors, namely questions dealing with; Trust, (Chu, (2009)), Loyalty, (Aydin & Özer, 2005), Familiarity, (Gremler, 2001) ,Rapport, (Gremler D. a., (2000)), Satisfaction, (Oliver R. , 1997) and Friendship, (Gremler D. D., (2000)) were selected from other research work and adapted to suit this study. These factors; trust, familiarity, rapport, friendship and care, also known as the five interpersonal bonds, were considered important since they seem to influence patients' choice of hospitals.

The fourth section embodied four questions directly related to the care scale by actors developed by (Gremler D. D., (2001), these four Care scale items were considered to be the second backbone of this research:

Ca1-Ca4 Care, Gremler (2001)

The questions on care were broadly organized to suit the purpose of this study as a whole. Some of these questions were also used by other researchers namely; (J.E.Ware Jr., 2005) (Flemmings, 1995), (M.Anderson, 1995) and (Korsch, 1977) in several related fields.

Finally the last part of the questionnaire contains eight questions which closely described the respondents. This section embodied the demographic characteristics namely, the gender, age, nationality, city of the resident, occupation, marital status, educational and income level.

The questionnaire was written mainly in the two most spoken languages in North Cyprus, that is, English and Turkish. It was designed and formatted to fit and be printed back to back. Also careful instructions to guide the respondents were clearly written at the top of the first page including the five point Likert scales which ranged from 1 to 5. These scales was constructed to specify responses by ticking or circling only the most suitable responses. The Likert scale used by (Albaum, 1997) is a scale composed of only 52 questions. An additional 8 questions deal with the demographic characteristics

making a total of 60 questions. As follow, the Likert scale is on a continuum with 1 rated as (strongly disagree), 2(disagree), 3(Indifferent), 4(Agree) and 5(strongly Agree).

### **3.2 Sample and Data Collection**

This study is set to observe and collect data from a defined population as proposed in the demographic section of the questionnaire (see appendix). The Sample population involved those who experienced health care service in any hospital within North Cyprus over the last 36 months. North Cyprus is ideal place for this research primarily because of its accessibility, the richness in its historical background, culture, environment, and its diverse residing population. A total of 410 questionnaires were printed and distributed in the cities of Gazimağusa, Girne, Lefkosia and Guzelyurt within the periods from December 2012 to March 2013 upon receiving the permission to do so from the managers of academic, commercial, and most especially, the health care sectors. Respondents were available within the cities mostly through hospitals, offices, schools, coffee shops and residential areas. A total of 346 answered questionnaires were obtained at the cut-off date for data collection .Only 300 response questionnaires were usable and the remaining 46 were rejected because they were incomplete, and hence a response rate of 86.7%, making it acceptable for this study.



### 3.3 FINDINGS

#### 3.3.1 Descriptive Analysis of Demographic Results

The demographic environment plays a major part in many empirical studies; firstly it involves people and people constitute a market .Secondly, changes in demographic setting have major effects on the economy (Kotler, 2005).

#### GENDER

Out of the total sample size of 300 properly completed questionnaires, the overall number of male respondents were of 149 (49.67%) and female were 151 (50.33%) Hence, a slightly higher percentage of females responded to the questionnaire as compared with the male respondents. This also supports the fact that a great number of female respondents were within the age range of 18-30years.

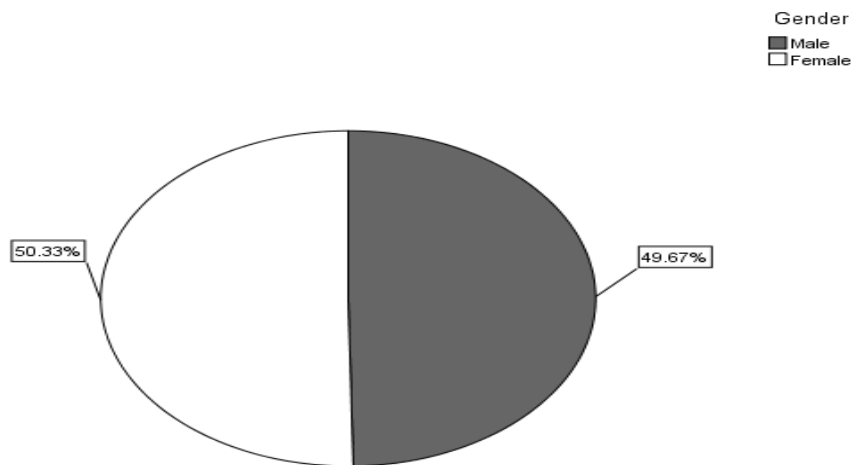

Figure 3: Distribution of Respondents by Gender.

## AGE

Figure 4 displays the age range distribution in percentages, whereby respondents under 18 years of age represented in total 8 (2.7%) of the sample size; whereas between the ages of 18-30, 168 (54.3%) were part of the sample size, and between the ages of 31-40, 74 (24.67%), between the ages of 41-50, 39 (13%), and between the ages of 51-60 a total of 11 (3.7%) and finally between the ages of 61 and above, just 5 (1.7%) were recorded as the smallest group of respondents. Most of the respondents were between the ages of 18 and 30 followed by the second largest group of respondents between the ages of 31-40.

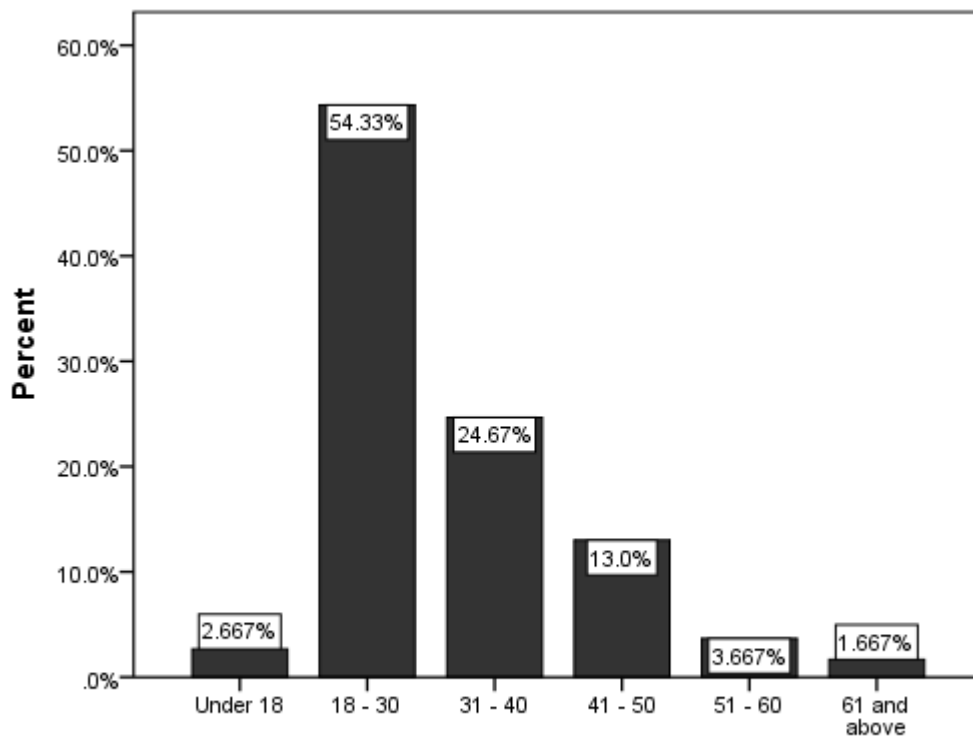

Figure 4: Distribution of Respondents by Age.

## NATIONALITY

Figure 5 shows the demographic characteristics of respondents by nationality. The graph below clearly distinguishes the number of respondents by nationality. The Turkish Cypriots respondents turned out to have the highest number of respondents with 164 (54.67%), seconded by other nationalities (Iranian, Ghanian, Cameroonian, British, Jordanian, Syrian, Nigerian and many more) in general with 71 (23.67%) respondents. The lowest percentage recorded was 65 (21.67%) from Turkish respondents. From the above statistical distribution, it appears that the highest response rate came from Turkish Cypriots.

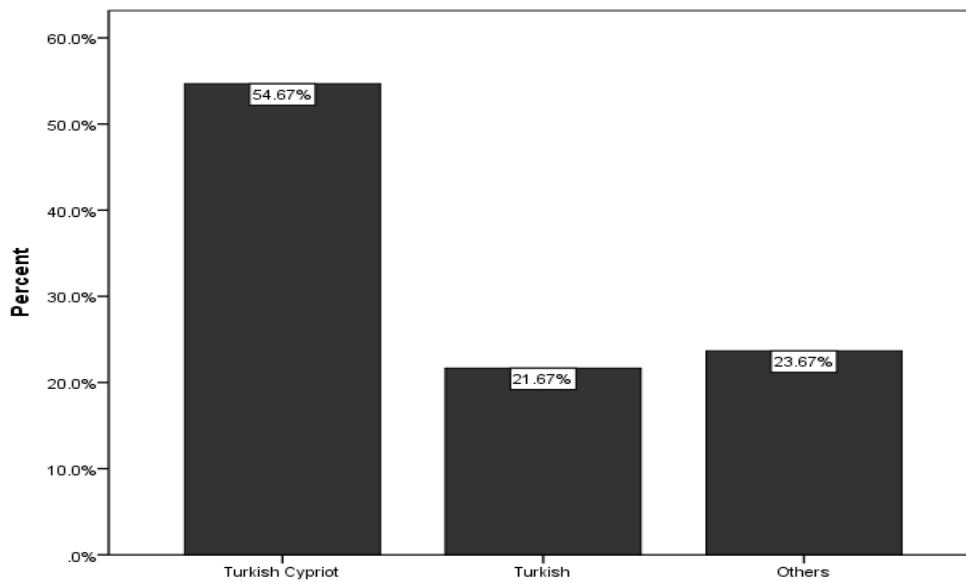

Figure 5: Distribution of Respondents by Nationality

## CITY OF RESIDENT

The majority of respondents were from the city of Gazimagusa which is mostly populated with student and foreign workers with a total of 206 (68.7%). The second largest respondents with 61 (20.3%) came from Lefkosa, the Capital city of North Cyprus, followed by Girne with 24 (8.0%) respondents and finally 9 (3.0%) were from different countries as temporary visitors.

Table 1: Distribution of Respondents by City of Resident respectively

City of Resident	Frequency	%
Gazimağusa	206	68.7
Girne	24	8.0
Lefkosa	61	20.3
Other	9	3.0
Total	300	100.0

## OCCUPATION

Figure 6 demonstrates the occupations of the respondents whereby students represented the highest number with 120 (40.0%), 52 (17.3%) of the respondents were from different professional backgrounds in both private and public establishments, with 38 (12.7%), and 34(11.3%) representing social workers and the unemployed, respectively. This was followed by the academicians and government workers with

the same number of respondents 14 (4.7%) respectively. Business owners ( self-employed) represented 13 (4.3%) of the respondents . Finally the lowest number of respondents with only 8 (2.67%) , 4 (1.33%) and 3(1.0%) came from retired persons (pensioners),farmers and clerks, respectively.

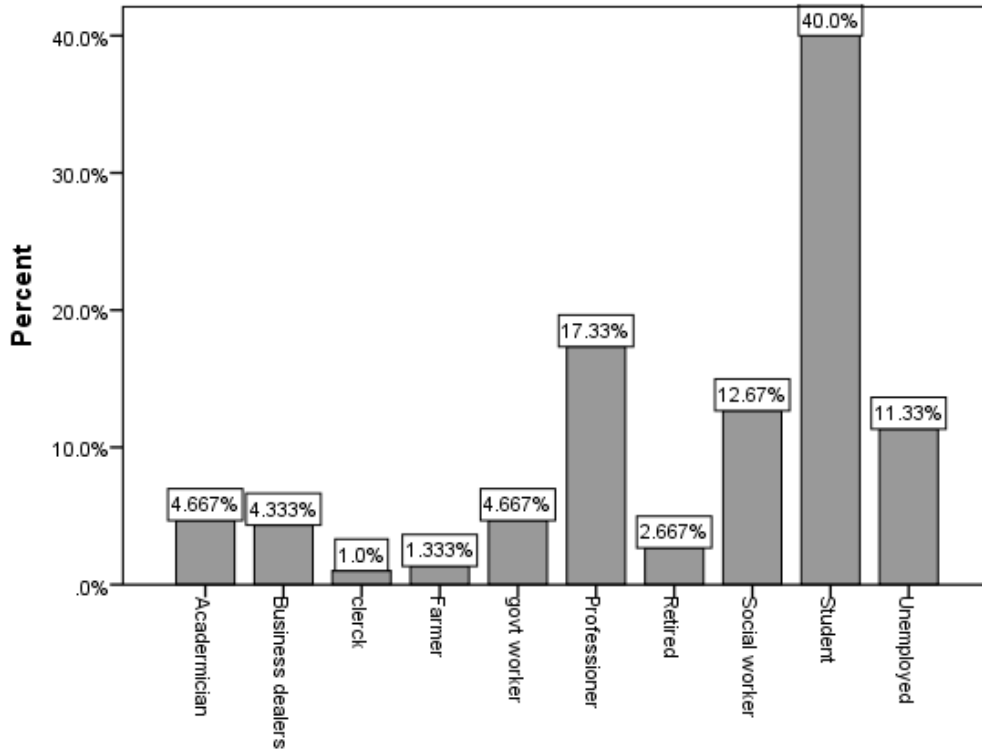

Figure 6:Distribution of Respondents by Occupation

## MARITAL STATUS

Figure 7 illustrates the marital status distribution by percentage which clearly indicates that more than half of the respondents were single with a total number of 158 (52.7% ), seconded by 117(39.0%) married respondents , and 16 (5.3%) were

divorced respondents, followed by any other status represented by a total of 9 (3.0%) respectively.

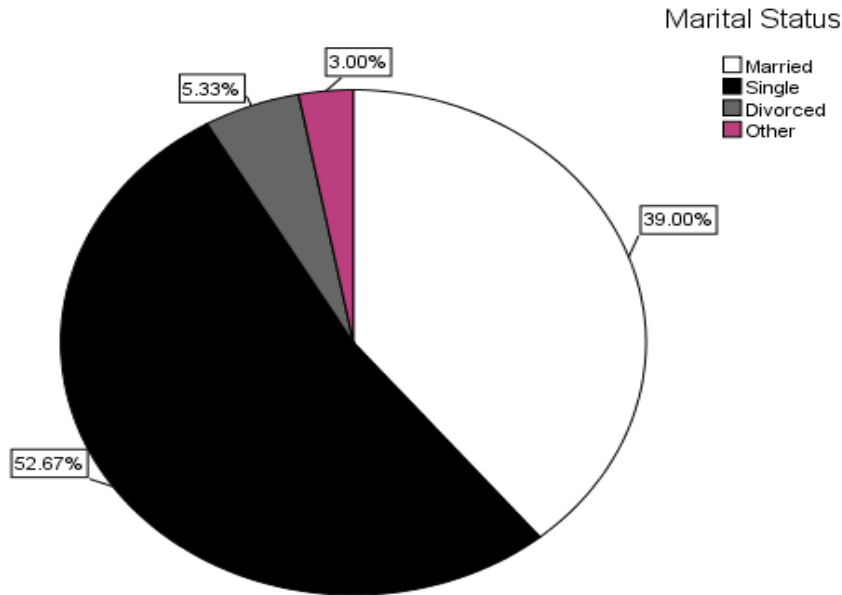

Figure 7: Distribution of Respondents by Marital Status.

### **EDUCATIONAL LEVEL**

Out of the total sample size of 300, the majority came from respondents who held Bachelor degrees representing a total of 167 (55.7%), followed by 69 (23.0%) respondents with a high school diploma. Thirdly, a total of 40 respondents (13.3%) had completed graduate work at a Masters level. A total of 8 (2.7%) respondents had achieved PhD, post-graduate levels, and secondary, along with the primary school levels, respectively, as seen on figure 8 below.

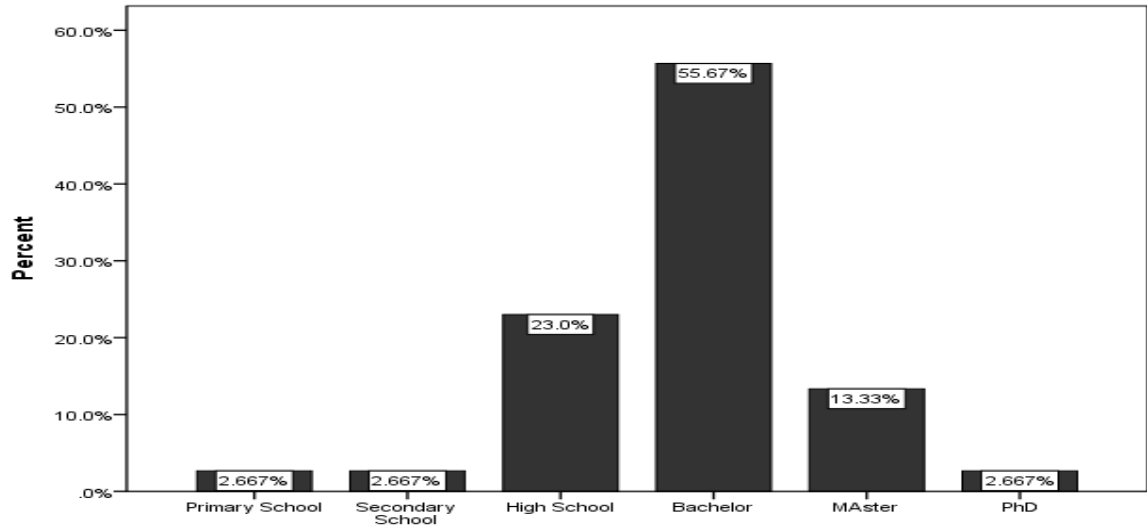

Figure 8: Distribution of the Education Level of the Respondents

### **MONTHLY INCOME LEVEL**

In terms of the monthly income levels, the majority represented by 105 (35.0% of the respondents) were between the income level of 1000TL to 2000TL, respectively. This was followed by 102 (34.0%) respondents who earned between 1000TL and less. Those that earned between 2000TL-3000TL were 53 (17.7%), while 29 (9.7%) respondents earned between 3000TL-4000TL and lastly, 7 (2.3%) of the respondents earned between 6000TL and more, and the lowest number of respondents, 4 (1.3%) with a monthly income between 4000TL to 6000TL as seen in Table 2 and Figure 9 below:

Table 2: Distribution of Respondents by Monthly Income Level

Monthly Income	Frequency	%
1000TL and less	102	34.0
1000TL – 2000TL	105	35.0
2000TL – 3000TL	53	17.7
3000TL – 4000TL	29	9.7
4000TL – 6000TL	4	1.3
6000TL and more	7	2.3
Total	300	100.0

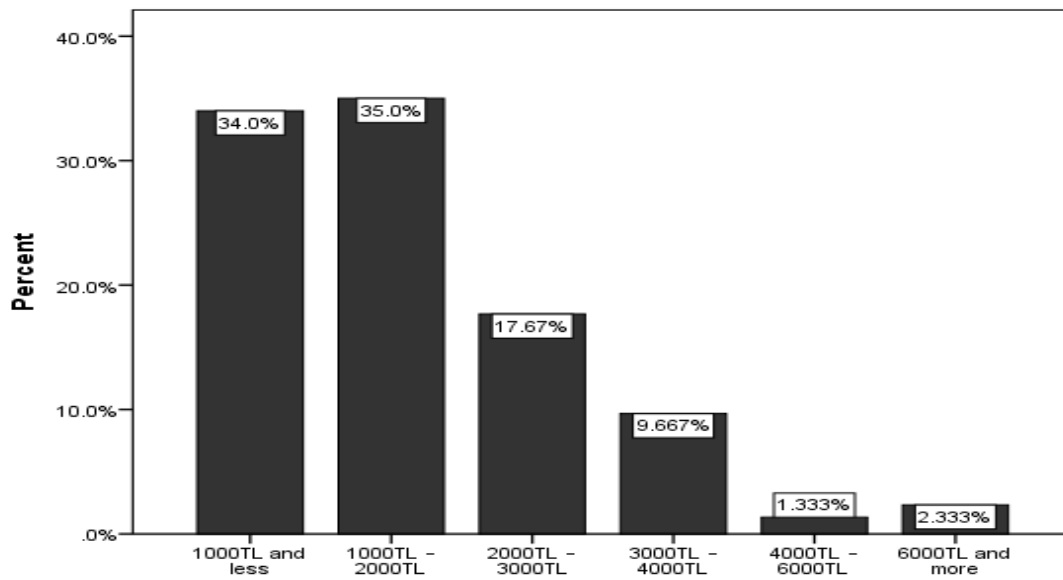

Figure 9: Distribution of Respondents by Monthly Income Levels



## HOSPITAL PREFERENCES

A number of patients may prefer a particular healthcare provider over another simply because of certain differences in the quality of care offered and also the location of the treatment site. (Yale bulletin 2000) .Hospital preference is highly linked to a patient's perception. Most Patients' choice of hospital is centered on comfort and safety (John & Dana P, 2011). Moreover, looking at the pie chart diagram below the majority of respondents preferred private/clinic hospitals by a margin of 48% .Some respondents (32 %) preferred the State hospital when in need of health care and lastly 20% of respondents preferred their personal physician in times of healthcare needs.

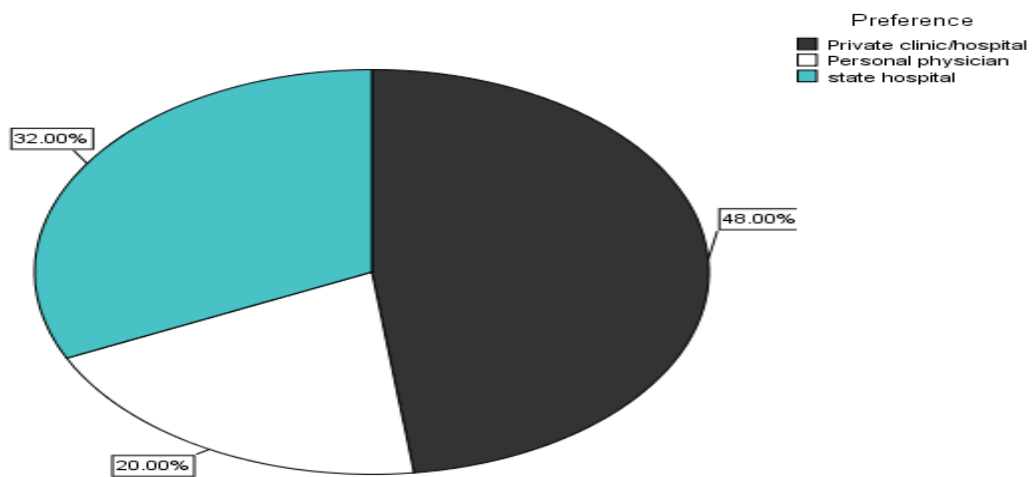

Figure 10: Illustrates Respondents' Preferences for Healthcare.

## HOSPITAL STATISTICS

Table 3 below illustrates some recent statistics in respect of the capacity and number of beds, doctors, nurses and other auxiliary staff available in the hospitals where the data was collected for this study. For instance, in some hospitals ( see Table 3) just a hand full of staff members were available in private hospitals, but surprisingly these

healthcare providers (\* private) seem to offer the best source of healthcare in the Turkish Republic of North Cyprus compared with those institutions with a significantly large number of staff (\*\* State Hospital). Furthermore, the aforementioned statement can be supported with the other findings from this chapter.

Table 3: Statistical Analysis of some State Hospitals and Private clinics

<b>Hospitals</b>	<b>Bed Capacity</b>	<b>Number of doctors</b>	<b>Number of Nurses</b>	<b>Auxiliary staff</b>	<b>Number of Data collected</b>
*Yasam Hospital	20	32	16	8	34
*Magusa Tip merkezi Hospital	16	53	13	52	25
*Yeni Nesil Dogum Hospital	5	2	5	1	17
*Kunter Guven Hospital	5	12	8	7	40
**Gazimagusa Devlet Hospital	147	48	133	179	80
*Near East Hospital	250	95	140	318	61
*Yuvam Dogum Clinic	6	2	3	1	10
Others	-	-	-	-	33

State hospital\*\*, Private clinic\*, Others (random location)

There are many private and public health care facilities all over North Cyprus .These hospitals provide emergency services at all times. Independent contractors like the dentist, opticians, gynecologist, pharmacist, dieticians, dermatologist, laboratory

technicians and many more, also greatly contribute to facilitate health service delivery to the population of North Cyprus. The majority of respondents were from the City of Gazimağusa (See table 1 and 3) .Other indicated respondents (33) from random locations such as road sides, shops and bus stops.

## Chapter 4

### DATA ANALYSIS AND RESULTS

#### 4.1 Descriptive Statistics

The procedure of this data analysis chapter involves the structural equation modeling (SEM) and projection to latent structures by means of partial least squares (PLS) from this version (Smart-PLS 2.0 M3). This tool was developed during the period between 1975-1982 by Herman Wold. The statistical PLS model process measurement package is designed to elaborate upon a small number of latent variables in which weighted averages in other words, linear combinations are estimated. PLS is used as a data analytical tool to observe the latent variables in this study because it can easily relate to multiple independent variable models with different estimated variables. This unique ability to assimilate many incomplete or correlated variables in a simple way explains the wide use of PLS today in many studies such as Simoglou et al (1999); Ghasemi & Seif,(2003); Sang et al,(2009); Huang et al,(2010).

The second statistical term, the structural equation model (SEM) is not dependent upon a single statistical approach, but works with a larger family of related procedures (Kline, 2010). One of the SEM techniques is the PLS, which permits multivariate procedures, combining features of multiple regression and is used simultaneously in the assessment of the structural path model. It evaluates analyses and also has the ability to (make

correlations) relate between constructs and their corresponding indicators (Fornell & Cha, 1994)

The PLS method measures the internal consistency, convergent and discriminant validity of the model constructs (variables). This method is very significant because it assesses individual items and evaluates the adequacy based on the reliability, convergent and discriminant validity. In this light alpha coefficients tend to be exceptionally appropriate indicators of the survey instrument's reliability (see Table 4).

## **4.2 Reliability and Convergent and Discriminant Validity**

### **Measurements**

One of the most frequently used reliability statistic tool today is known as the Cronbach's alpha ( $\alpha$ ). This tool determines the internal average correlations of a survey instrument to measure its reliability. In other words, Cronbach Alpha (1951), ensures and evaluates only the reliability and the validity of the survey instrument (questionnaire) and applies a relationship approach to the conceptual network. However, the coefficient values (see Table 4) were highly significant; suggesting all 28 selected items were within the acceptable scale, thus suitable for further analysis. The results depicted high reliability, indicating all factor values were above recommended level of 0.70 (Table 4), signifying an adequate internal consistency (Nunnally, 1978). The rationale behind this analysis was to measure the extent to which the homogeneity each item measured up to the construct.

Table 4: Describes the Reliability and Convergent Validity Scores

<b>RELIABILITY ANALYSIS AND CONVERGENT VALIDITY</b>			
<b>FACTORS</b>	<b>NO OF ITEMS</b>	<b>CRONBACH ALPHA (<math>\alpha</math>)</b>	<b>AVERAGE VARIANCE EXTRACTED</b>
Friendship	7	0.86	0.60
Familiarity	5	0.87	0.65
Trust	3	0.85	0.77
Care	4	0.88	0.73
Loyalty	4	0.85	0.70
Rapport*	5	0.91	0.74

recommended level 0.70 indicates the items are free from random error and that the internal consistency is adequate (Bogazzi & Yi 1988; Fornell & Larcker, 1981). Table 4 confirmed Rapport\* with the highest level of alpha coefficient indicating the degree of importance interaction and communication played in customer/service provider relationships in order to deliver a satisfactory outcome (Harrigan, 1983; Tickle-Degnen, 1987 ; Kritzer, 1990)

Another tool used in this study was the discriminant validity statistic tested by exploring the average variance shared between the variables(observed items) and the measured average variance expected (AVE).The recommended variance extracted should exceed the threshold of 0.50 in order to confirm AVE (Fornell & Larcker, 1981; Bogazzi,

1988) .These items corresponded to each of the constructs and maintained the result scale variances of 0.60 to 0.77 (see Table 04) .In addition, another suggested measurement to be considered is the adequate discriminant validity, when the square root of average variance extracted is more than the correlation between the construct in the model.(Fornell & Larcker (1981)). However, the convergent Validity is established if the AVE exceeds the recommended level of 0.10

Table 5: Correlation among the Construct Scores

	<b>Friendship</b>	<b>Familiarity</b>	<b>Trust*</b>	<b>Loyalty</b>	<b>Care</b>	<b>Rapport</b>
Friendship	<b>0,77</b>	0	0	0	0	0
Familiarity	0,8002	<b>0,81</b>	0	0	0	0
Trust	0,6806	0,7225	<b>0,88</b>	0	0	0
Loyalty	0,7006	0,776	0,7511	<b>0,86</b>	0	0
Care	0,7836	0,7701	0,7087	0,6878	<b>0,83</b>	0
Rapport	0,8161	0,8371	0,6904	0,7203	0,7761	<b>0,86</b>

The square roots of AVE are illustrated on the diagonal pattern as seen on the Table 05 above. However it is also noticed that no correlation coefficients are above 0.90 and all the results indicated variables representing different constructs (Amick & Walberg, 1975). Trust\* depicted as 0.88, Loyalty and Rapport depicted the same value 0.86, respectively. Technically, as observed, Trust has the highest value of 0.88, denoting that it gives important information about the correlation with other constructs. We can also

argue that any other values less than 0.81 have little correlation with the other constructs.

Table 6 below presents the composite reliability of factor loadings for each variable.

This means variables were selected to relate the importance of individual respondents on certain factors when choosing a particular healthcare provider during times of need. The minimum factor loading was 0.662 from Friendship and maximum 0.910 from Trust, out of 28 factors.

Table 6: Shows Factor Loadings of all Variables

Variables	Factor Loadings
Friendship	
Fri. 1	0,784
Fri. 2	0,825
Fri. 3	0,859
Fri. 4	0,687
Fri. 5	0,662
Fri. 6	0,771
Fri. 7	0,784
Familiarity	
Fam. 1	0,797
Fam. 2	0,737
Fam. 3	0,855
Fam. 4	0,835
Fam. 5	0,804
Trust	
Trust 1	0,836
Trust 2	0,910
Trust 3	0,890
Loyalty	
Loy. 1	0,853
Loy. 2	0,811
Loy. 3	0,879
Loy. 4	0,881
Care	



Care 1	0,861
Care 2	0,835
Care 3	0,851
Care 4	0,789
Rapport	
Rap. 1	0,768
Rap. 2	0,869
Rap. 3	0,895
Rap. 4	0,885
Rap. 5	0,873

“Table 6 (continued)”

Moreover, the following expected mean scores (see Table7) indicated the most important conditions for customers, especially when choosing a healthcare provider. “Trust” (mean score = 3.57), “Friendship” (mean score = 3.52), “Loyalty”(mean score = 3.50), followed by “Care”(mean score = 3.44) “Rapport”(mean score = 3.40) and “Familiarity”(mean score = 3.38) .On the other hand ,the most important factors that influenced respondents in search of quality and satisfactory services were “Trust” (mean score = 3.57), “Friendship” (mean score = 3.52), “Loyalty”(mean score =3.50) and “Care”(mean score = 3.44) , followed by the least important factors that influenced patient/respondents satisfaction and choice of healthcare , “Rapport”(mean score = 3.40) and “Familiarity”(mean score = 3.38) as seen below:

Table 7: Shows Mean and Standard Deviation of all Variables (*excluding satisfaction*)

<b>Selected Important Factors that Influence Patients' Satisfaction</b>	<b>MEAN</b>	<b>STANDARD DEVIATION</b>
Trust	3.57	0.97
Friendship	3.52	0.84
Loyalty	3.50	1.04
Care	3.44	0.96
Rapport	3.40	1.00
Familiarity	3.38	0.93

Table 7 above as well shows the Standard Deviation values also known as the positive square root of the variance. This is used in this study to measure the dispersion of the variables from the mean, that is, the degree of variation in the above data set apart from the mean. A data with the highest variation has the greatest relative spread. Mean and Standard Deviation is used to demonstrate the composite measurement of discriminant validity and convergent in the model .The 28 items estimated did not show any problems with the frequency analysis which ranged from 1.00 – 0.97 which was within the recommended level.

Partial Least Square (PLS) is also essential for loading and path coefficients as explained ahead, measures the relationship and connections between path coefficients

and different constructs. One of the main benefits of PLS is that loading and path coefficients function simultaneously. Path coefficients indicate predictive capability of the model. PLS in addition, estimated the structural model which is another important function analyzed in this study as seen in Table 08 .This model also shows the influence of each structure on the other structures by simply explaining path coefficients in terms of  $R^2$  known as variance. Cohen (1988) gauged  $R^2$  values as follows: 0.26 as Significant, 0.13 as Adequate and 0.02 as Weak. While Lohmöller, (1989) judged any range greater more than 0.1 as acceptable in the path coefficients.

### **4.3 Structural Model(s) Results and Hypotheses Testing.**

PLS uses the above mentioned techniques basically to minimize error (Hulland, 1999). According to (Wetzels, M; Odekerken-Schroder; G., & Van Oppen C. 2009; Tenenhaus et al; 2005), there are three standards to determine a model's overall quality as follows: the quality of the measurement model, the structural model and the regression equation used.

Table 8, illustrates the structural model by developing R-square ( $R^2$ ) for each of the constructs ,the significant level (P-value) of the path coefficients and the t-statistic value. Basically these statistics help indicate the influence of Care offered by a healthcare provider to a customer. That is, the impact of Care on Familiarity in terms of  $R^2$ .The relation between Care and Familiarity is significant with  $\beta$ -value = 0.77, t- value = 16.73 and  $R^2 = 0.59$  which concluded that the supposed factor, Familiarity has a

positive influence on Care .This would suggest that a 100 point change in Care would lead to a 77 point change in Familiarity.

Trust ( $R^2 = 0.58$ ) is also another factor to be measured as represented in Table 08. It shows the relationship between Trust and Familiarity *H3*, and Care *H7* with  $\beta$ -values = 0.72, 0.31, t-values = 13.69, 2.53, p-value = 0.00\*, 0.01\*\*, respectively. These factors have a positive influence on consumer Trust; therefore, *H3* and *H7* are accepted. As indicated by the results of this study, all the hypotheses were supported, except for *H6* with a t- value = 0.97 and  $\beta$ -value =0.33(see Table 8 and Fig.11). This can be an indicator that Friendship has little or a weaker impact on a customer's level of trust, implying no significance. As explained earlier ,a 100 points change in Familiarity and Care will lead to a 72 and 31 points change in Customers' Trust, respectively. The accepted significant level is within 0.01- 0.05, and any value more than the recommended range is rejected or seen as a weaker construct and insignificant (Lohmöller,1989).

Table 8 Illustrates the Inner Structural Model (a)

<b>Influence on Care (<math>R^2=0.59</math>)</b>	<b>Proposed Effect</b>	<b><math>\beta</math></b>	<b>T- value</b>	<b>p-value</b>	<b>Hypotheses</b>
Familiarity (H1)	+	0.77	16.73	0.00*	Accepted
<b>Influence on Friendship (<math>R^2=0.90</math>)</b>					
Familiarity (H2)	+	0.80	17.36	0.00*	Accepted
<b>Influence on Trust (<math>R^2=0.58</math>)</b>					
Familiarity (H3)	+	0.72	13.69	0.00*	Accepted
Friendship (H6)	+	0.14	0.97	0.33	Rejected
Care (H7)	+	0.31	2.53	0.01**	Accepted
<b>Influence on Rapport (<math>R^2=0.77</math>)</b>					
Familiarity (H4)	+	0.84	24.12	0.00*	Accepted
Friendship (H5)	+	0.32	2.79	0.01**	Accepted
Care (H8)	+	0.19	1.95	0.05***	Accepted
<b>Influence on Loyalty (<math>R^2=0.64</math>)</b>					
Rapport (H9)	+	0.39	4.15	0.00*	Accepted
Trust (H10)	+	0.49	5.33	0.00*	Accepted

Structural (inner) model (a) result \*  $p < 0.01$ ; \*\*  $p < 0.05$ ; \*\*\*  $p < 0.10$

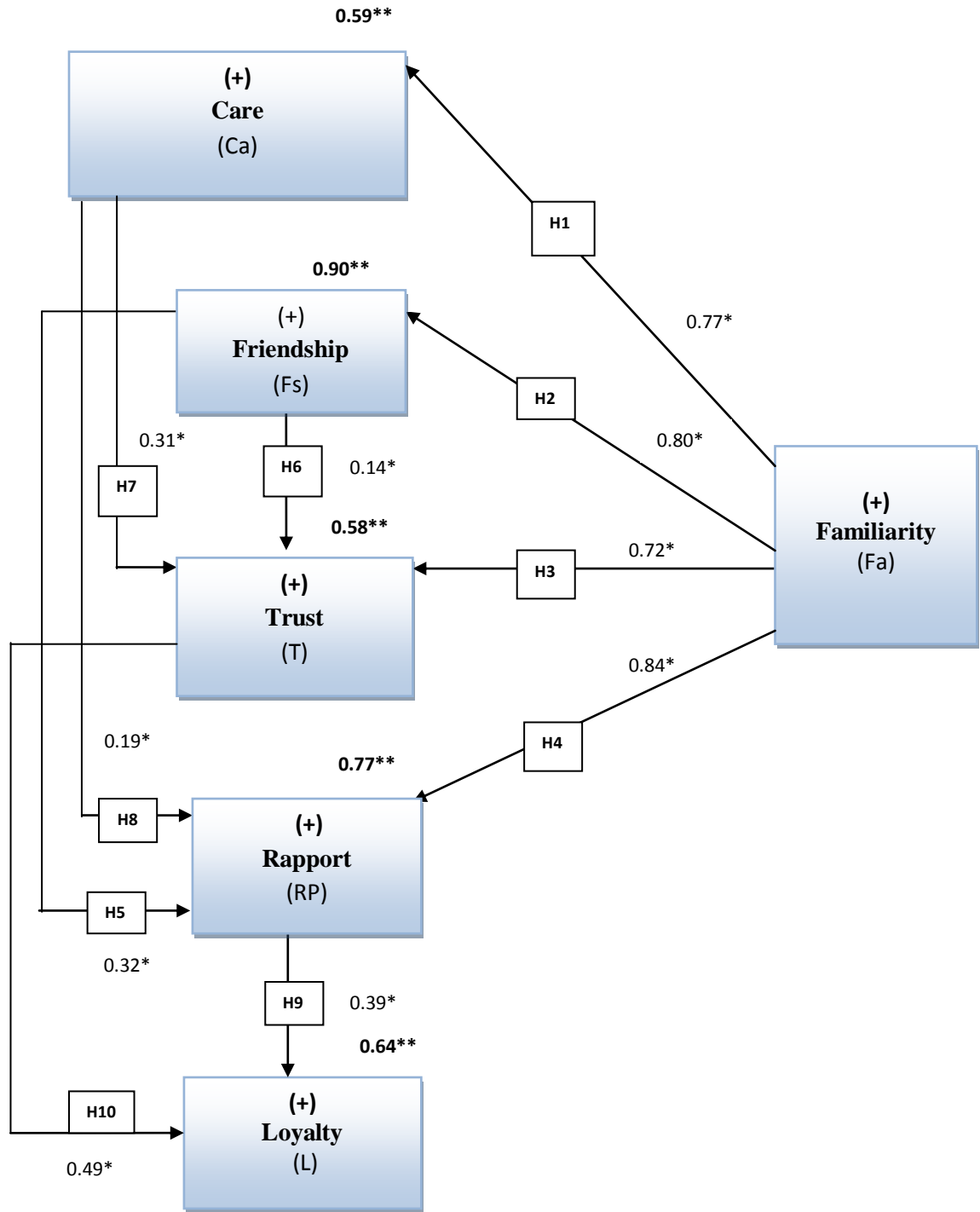

Figure 11: Evaluate Conceptual Model (2a) *excluding Satisfaction*

*Path Coefficients are described with \*, R<sup>2</sup>(\*\*), Proposed effects (+)*

#### **4.4. Data Analysis and Description Model (b).**

Basically, the aforementioned model (a) indicated all factors except Satisfaction as seen in chapter 2 on structures. This section described the factors in conjunction with Satisfaction. These items are assessed based on the result of the reliability, convergent and discriminant validity (See table 4).The Cronbach's Alpha ( $\alpha$ ) which measured reliability of the questionnaire was highly significant; all 28 plus 4 satisfaction items which summed up to 32 items were suitable for further analysis as stated in the second model (b) .These 4 satisfaction items included were confirmed to be above the recommended  $\alpha = 0.70$ . Rapport, once more recorded as highest with ( $\alpha = 0.9$ ) and the lowest coefficient came from Familiarity and Satisfaction with ( $\alpha = 0.85$ ) respectively.

Another observed test was (AVE) with a recommended threshold of 0.50. All factors output were above 0.50 (see Table9) below. Satisfaction recorded the second highest coordinate of 0.69, after Care, with 0.70, confirming that these two factors have more correlation between other constructs in the model (b).

Composite reliability also known as internal consistency approach is almost similar to Cronbach's alpha investigation Although composite reliability is unaffected by scale length and has a more general approach, it can also be interpreted according to the guidelines adopted and confirmed by Nunnally (1978). As Observed in Table 9, all the reliability measurements were above the recommended level of 0.70. Rapport recorded 0.93, seemingly the highest of all factors within this Composite reliability test, thus indicating an adequate internal consistency (Nunnally, 1978).

Table 9: Describes the Reliability and Convergent Validity Model (See Fig 02b)

<b>RELIABILITY ANALYSIS AND CONVERGENT VALIDITY (b)</b>				
<b>FACTORS</b>	<b>NO OF ITEMS</b>	<b>AVE</b>	<b>COMPOSITE RELIABILITY</b>	<b>CRONBACHS ALPHA</b>
Care	4	0,70	0,90	0,86
Familiarity	5	0,51	0,89	0,85
Friendship	7	0,65	0,90	0,87
Loyalty	4	0,73	0,92	0,88
Rapport	5	0,74	0,93	0,91
*Satisfaction	4	0,69	0,90	0,85
Trust	3	0,63	0,91	0,88

\*(Added Factor)

The square roots of AVE are distributed on the diagonal pattern as seen on Table 10 below. Rapport and Loyalty recorded the same values with the highest correlation of 0.86 , followed by Care with 0.84 , Satisfaction with 0.83, Friendship with 0.81 ,Trust 0.79 and lastly, Familiarity with the minimum level of 0.71. Moreover, all items were within the recommended level of 0.70, thus, acceptable for further analysis.

Table 10:Correlation Amongst Construct Scores

	<b>Care</b>	<b>Familiarity</b>	<b>Friendship</b>	<b>Loyalty</b>	<b>Rapport</b>	<b>Satisfaction</b>	<b>Trust</b>
<b>Care</b>	<b>0.84</b>						
<b>Familiarity</b>	0,806889	<b>0.71</b>					
<b>Friendship</b>	0,750269	0,813643	<b>0.81</b>				
<b>Loyalty</b>	0,678312	0,714364	0,776461	<b>0.86</b>			
<b>Rapport</b>	0,795386	0,819465	0,836721	0,721192	<b>0.86</b>		
<b>Satisfaction*</b>	0,715136	0,726500	0,726320	0,784708	0,741341	<b>0.83</b>	
<b>Trust</b>	0,726718	0,719801	0,761025	0,740427	0,723171	0,753127	<b>0.79</b>



Table 11 shows the expected mean and standard deviation factor scores, illustrating composite measurement of discriminant validity and convergent. The most important factor which influenced respondents' choice of healthcare as regards to satisfaction is Trust (mean = 3.57), while Friendship scored (mean = 3.55). Familiarity recorded the lowest score (mean = 3.24). These scores show the overall expectation of customers' satisfaction regarding the choice of hospital in accordance with certain factor preferences.

Table 11: Illustrates Mean and Standard Deviation of each Variable

<b>Selected important factors that influence patient satisfaction</b>	<b>MEAN</b>	<b>STANDARD DEVIATION</b>
Trust	3.57	0.97
Friendship	3.55	0.84
Loyalty	3.50	1.04
Care	3.45	0.96
Rapport	3.41	1.00
Familiarity	3.24	0.93
Satisfaction*	3.50	1.03

(\*Indicates added factor)

Table 12: Describes each Variables Factor loading items

<i>Variables</i>	<i>Cross Loadings</i>
<b>Care</b>	
Ca1	0,864
Ca2	0,828
Ca3	0,855
Ca4	0,798
<b>Familiarity</b>	
Fa1	0,711
Fa2	0,320
Fa3	0,354
Fa4	0,855
Fa5	0,803
<b>Friendship</b>	
Fs1	0,683
Fs2	0,675
Fs3	0,666
Fs4	0,481
Fs5	0,518
Fs6	0,625
<b>Loyalty</b>	
L1	0,857
L2	0,805
L3	0,878
L4	0,882
<b>Rapport</b>	
Rp1	0,767
Rp2	0,870
Rp3	0,895
Rp4	0,885
Rp5	0,873
<b>Satisfaction*</b>	
St1	0,863
St2	0,889
St3	0,852
St4	0,704
<b>Trust</b>	
T1	0,843
T2	0,823
T3	0,768
T4	0,823
T5	0,662

(\*Added Factor)

## 4.5 Initial Path Model Analysis

Table 12 describes the factor loadings for each variable. Hulland (1999), specified that all factor loadings should exceed 0.50. The items corresponding to each of the constructs are summed and averaged in order to obtain composite scores. As illustrated in Table 12, the minimum loading item with (0.320) recorded resulted from Familiarity, while the highest loading (0.895) was obtained from Rapport. Researchers like Nunnally (1978) have suggested that the values below 0.50 also contribute significantly to influence other estimated factor loadings as a whole. These Factors below the rule of thumb (e.g., 0.320) still influence test score interpretations significantly.

The quality of any measuring model should be able to evaluate and determine each items reliability, convergent and discriminant validity standards. PLS procedure is applied to observe the affiliation of each of the factor measurements and loadings. Thus Fig 12 illustrates the sub-factors that significantly influence the main factor component. Beta Value ( $\beta$ ) should exceed 0.10 (Fornell & Larcker, (1981)). Thus all sub-factors /items significantly influenced customers' expectations such as: Trust, Loyalty, Familiarity, Rapport, Friendship, Care and Satisfaction. Cohen, (1988) assessed  $R^2$  values as follows : ( 0.26 - Considerable), (0.13 - Adequate) and (0.12 – Weak) .Furthermore, Lohmöller, (1989), confirmed any range above 0.1 as appropriate. R- square values determine how accurate a model matches the hypothesized relationship, that is, in terms of the construct's variation percentages (Wixom, 2001).

Figure 12 illustrates the relationship between Care ( $R^2 = 0,567$ ) on Trust ( $R^2 = 0,622$ ) ( $\beta = 0,170$ ), and Rapport ( $R^2 = 0.700$ ) ( $\beta = 0.476$ ). This test assesses individual item scale reliability as well as the convergent and discriminant validity of each of the constructs. PLS results showed the relationship's, loading values and coefficient results in Figure 12 and 13. Beta values were all above the minimum level of 0.10, thus, acceptable. The highest  $\beta$  recordings originated from the following relationship paths: Familiarity and Rapport ( $\beta = 0,837$ ), Familiarity and Friendship ( $\beta = 0,800$ ) Satisfaction and Loyalty ( $\beta = 0,786$ ), and the Lowest ( $\beta = 0,170$ ) came from Care and Trust. (see fig.12)

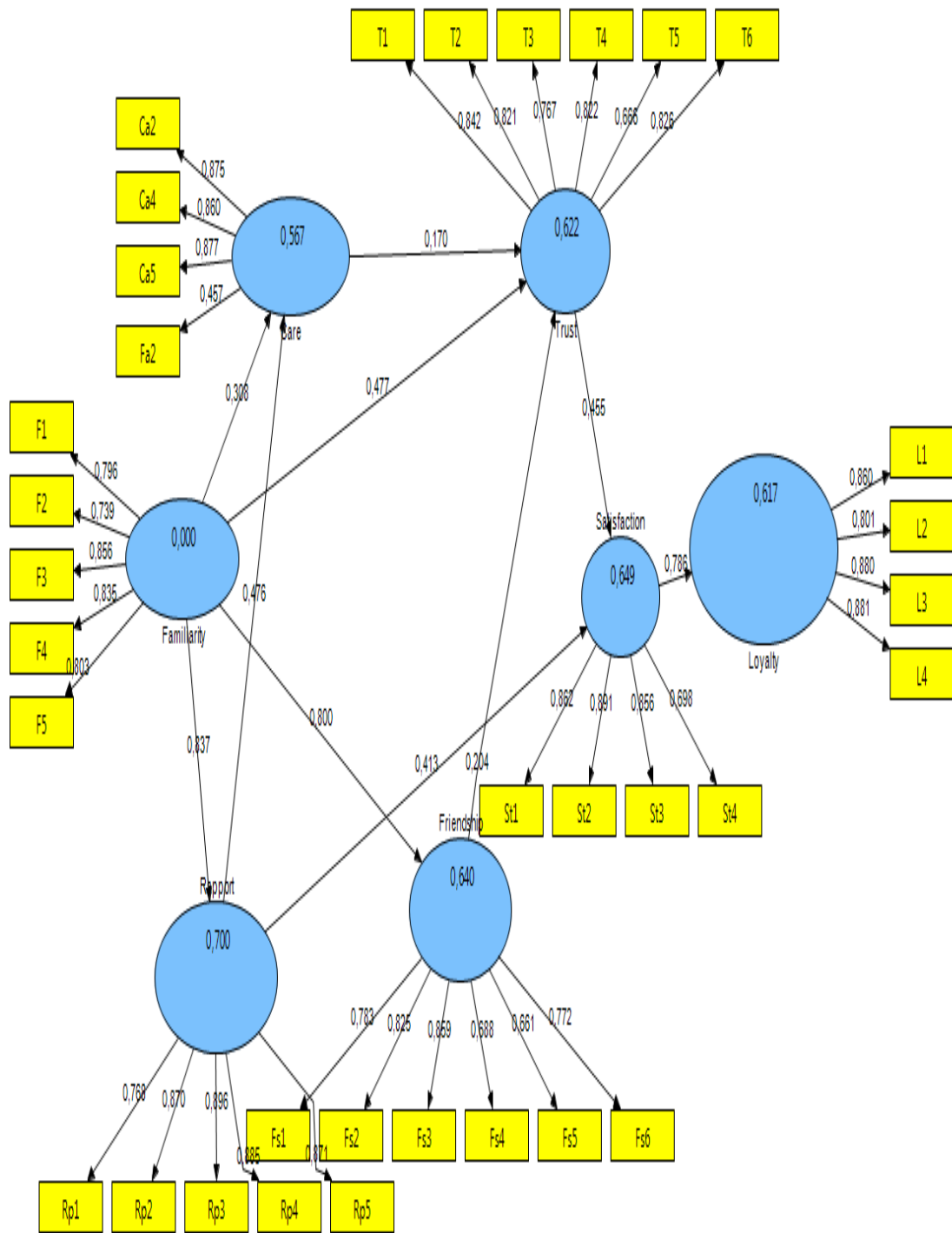

Figure 12: Initial Path Model (b) Illustrates r-square, beta-Values and Coefficients

The t - values of all individual item scales (see Figure 13) were above the recommended level of 10%. That is, Care has a direct positive influence on customer's Trust and Rapport.(See fig.12) thus, confirming *H7* and *H8*, respectively. Another observed finding was Familiarity ( $R^2 = 0,00$ ), however, it had positive influences on friendship ( $\beta = 0,800$ )(  $R^2 = 0,640$ ), Rapport ( $\beta = 0,837$ ) (  $R^2 = 0,700$  ), Trust ( $\beta = 0,477$ )(  $R^2 = 0,622$ ) and Care( $R^2 = 0,567$ )(  $\beta = 0,308$  ), with regard to the observations made by Wixom,( 2001) the results obtained in this study support the hypotheses *H2*, *H4*, *H3* and *H1* respectively.

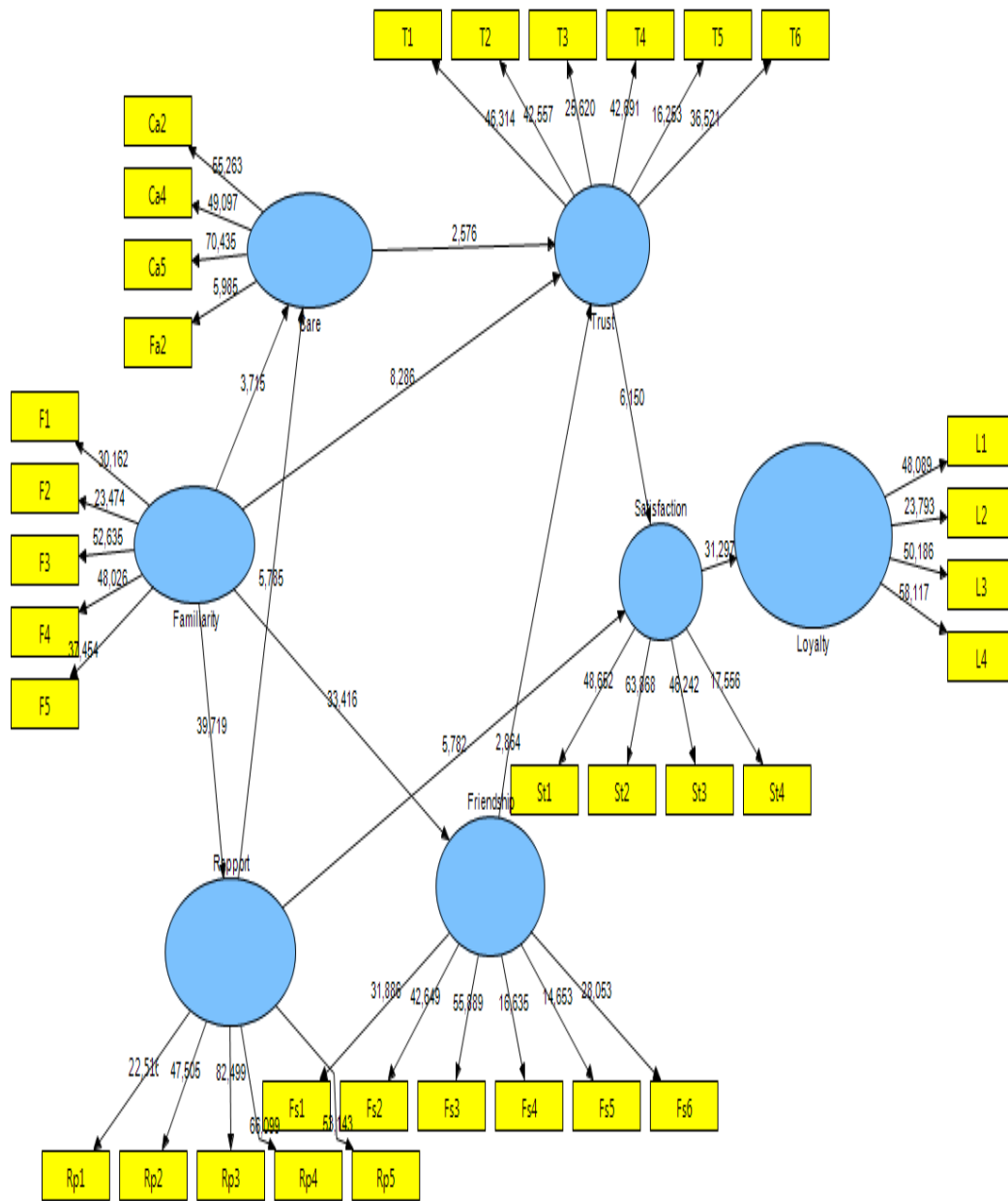

Figure 13: Illustrates t- Statistics of all Variables

## Chapter 5

### DISCUSSIONS AND RECOMMENDATIONS

#### 5.1 Conclusions

This study hypothesized the relationships of some five interpersonal bonds as aforementioned alongside satisfaction and customer loyalty. Building satisfaction and customer loyalty can be achieved by acknowledging each individual's needs and wants. This Study confirm that organizational advantages, from relationship marketing increased re-visit intentions, has made a lot of progress, as well as advertising through positive word of mouth (Zeithaml and Bitner 1996). However, relationship marketing tactics need specific information about the kind of influence they (healthcare providers /service providers) convey to different customers, most especially in the healthcare sector, where service quality and interpersonal bonds contribute wholly to retain Customers. Thus, this study empirically validates several significant levels as to what customers expect in terms of ServQual and the five interpersonal bonds. In addition, to this study, a series of statistical tests and results were realized; for example, servQual was measured with some defined variables in order to verify and improve those service dimensions needed in the healthcare sectors. (Brown, Churchill & Peter 1993).

Another important area of this study is the reliability, convergent and validity measurement scores which to some extent fulfilled the psychometric requirements.



## **5.2 Employees Perspective**

Service businesses should encourage employees to create relationships, and have discussions to help them find solutions to customer problems. Such determination of action may lead to developing a customer's level of trust. Training and awards should be given to employees to help improve their social interaction skills at a professional level. This study demonstrated that the expectations that the patients had with regard the health services, was met neither in the private nor in the state hospitals in TRNC. It was surmised that the criticism about the service quality in North Cyprus still remains a factor to be considered. The respondents who were citizens of North Cyprus (stood out as the highest (54.67%) in this study, signifying that the findings from this field of study should be implemented and not be underestimated by any means.

## **5.3 Implications**

A deeper understanding of the effect of customer satisfaction as well as loyalty retention is very important, since relationship marketing is essential in building customer trust, friendship, rapport and familiarity, keeping and winning a patient in the service industry, especially healthcare institutions greatly depends on Care alongside satisfactory adjustments. Some customers require more support than others (old and young generation) (rich and the deprived) (switchers and stayers) and (educated and uneducated). While some customers are different in their expectations and perception when making decisions. However, in terms of management considerations, this study proposes that employees ( service providers) in hospitals in North Cyprus and those

countries (institutions) faced with – How/when/where to satisfy/retain customer – should focus on recognizing heterogeneous characteristics in customers and deal with those particular segments as required in order to provide exceptional services. The TRNC government should emphasize long-term strategy plans such as: investing more resources into the healthcare sector, organize campaigns pertaining to the benefits of hospital care, reduce taxes and operational cost for all hospitals, encourage the inflow of foreign investors and also encourage sponsorship/partnership with other nations. The TRNC government should organize frequent training workshops for the healthcare staff, motivational schemes to keep their qualified and skilled staff from leaving the country.

#### **5.4 Limitation and Future Research Guidelines**

This research has contributed to enhance the idea of service marketing tactics alongside interpersonal bonds; therefore, findings from this study should not be underestimated. It has provided important source of knowledge for managers within the healthcare institutions, as well as the service industry in general. Despite the limitations, further research findings can be valid if used in a broader perspective. However, the results and conclusions could be ideal to service environments; for instance, telecommunication, transport agencies, and financial institutions equally. Customer relationship management (CRM) needed to be thoroughly discussed in this study which proposes another area for future studies such as a combination of all the variables affecting customer satisfaction alongside CRM should be another area for future research interest. Researchers need to acquire further knowledge on the causal foundation amongst these variables (broaden the scope) since the topic of interest is a dynamic phenomenon (inter-personal bonds).

## REFERENCES

- Abramowitz, S. C. (2009). Patient-Reported Outcome Measures: The Importance of Patient Satisfaction in Surgery. *Journal of Surgery*, 436.
- Aksarayli, B. e. ([2010]). Private HealthCare Quality: Applying a ServQual Model. *International Journal of Health care Quality Assurance*, 658-673.
- Albaum, G. (1997). The Likert Scale Revisited: An Alternate Version. *Journal of the Market Research Society*, p 33.1.
- Anderson, E., & Lehmann, D. (1994). Customer Satisfaction: Marketshare and Profitability: Findings Sweden. *Journal of Marketing* , Vol.58,53-66.
- Angur, M. R. (1999). "Service quality in the Banking Industry: an assessment in a developing economy",. *International Journal of Bank Marketing*,, Vol. 17 pp.116
- Antreas, O. ,. ([2010]). Private Healthcare quality:.. *International Journal of Health Care*, 658-673.
- Agdelen, Z., Ersöz, B. T., & Sarp, N. (2010). Working Conditions of the Governmental and Private Hospital Doctors in North Cyprus. *International Journal of Pharmaceutical and Healthcare Marketing*, 4(2), 191-204.
- Ashill, N. J., & Krisjanou, J. (2005). Antecedents and Outcomes of Service Recovery Performance. *Journal of Service Marketing* , pp.293-308.
- Amick, D., & Walberg, H. (1975). *Introductory Multivariate analysis*. California: Mc

Cutchan Publishing corporation.

Arikan, H. (2005), Personal Interview, Ministry of Health, Nicosia, 10 March.

Aydin, S., & Özer, G. (2005). The Analysis of Antecedents of Customer Loyalty in the Turkish mobile telecommunication market. *European Journal of Marketing*, 39.7/8: 910-925.

Babakus, E. (1992). An Empirical Assessment of the SERVQUAL scale to hospital services. *Health Service Research*, Vol 26 No.6, pp.267-80.

Bergman, B. a. (1994). *Quality from Customer Needs To Customer Satisfaction*.

Berry, L. L., & Bendapudi, N. (2007). Health care: A fertile field for service research. *Journal of Service Research*, 10(2), 111–122.

Bhatta. ((2001)). Private healthcare Quality. *International Journal Of Health care Quality Assurance*, 659.

Bitner M.J., F. R. (1998). An Investigation into Four Characteristics of services. *Journal of Empirical Generalisation in Marketing Science*, 24.

Blanchard CG., L. M., & JC., R. (2009). The Importance of Patient Satisfaction in Surgery. *Journal of Surgery*, 437.

Bowen,J.T.,& Chen,S.L (2001)The Relationship between Customer Loyalty and Customer Satisfaction,*International Journal Of Contemporary Hospitality Management*,13(5),213-217

Boshoff., C., & Gray., B. ([2004]). The Relationship between Service quality and customers Satisfaction and Buying Intentions in the private Hospital industry.

*Business Management*, 27-37.

- Buttle, F. (1996). SERVQUAL: Review, Critique, Research Agenda. *European Journal of Marketing*, 30(1), 8–32.
- Bogazzi, R. P. (1988). On the Evaluation of Structural Equation Models. *Journal of Academy of Marketing Science*, 16 (1), 74-94.
- Busch, P., & David, T. (1976). "An Experimental analysis of a salesman's Expert and Referent Bases of social power in the Buyer-Seller Dyad, . *Journal of Marketing Research*, 13 (February),3-11.
- Caldow, D. P. ((2000)). The Impact of Friendship between Consumers and service-Providers on loyalty to the service firm. *Visionary Marketing for the 21st Century: Facing the Challenge*, 161-164.
- Carman, J. (1990). "Consumer perceptions of Service quality: an assessment of the SERVQUAL dimensions". *Journal of Retailing*, Vol. 66 No.1, pp.33-5.
- Chin, W. (1996). "The partial Least Square for Structural Equation Modeling". In *Modern Methods for Business Research*,. New Jersey(Erlbaum).
- Chollet, D. (1996). "*Redefining Private Insurance in a changing Market Structure*" In *strategic choices for a changing health care system*, edited by S.Altman and U.Reinhardt. Chicago: Health Administration Press.
- Cochrane. ([1997]). *Patient Satisfaction. Elsevier Journal*, 1829-1843.
- Coutler.A. (2003). The Autonomous Patient. *Health Clinical Policy*, e197-e202.
- Cronin, J. J. (1992). "Measuring service quality: a re-examination and extension".

*Journal of Marketing*, Vol. 56 pp.55-68.

Cohen, J. (1988). *Statistical Power Analysis for the Behavioral Sciences*. Routledge Academic.

Crosby, L. A., & Cowles, D. ((1990)). Relationship Quality in Services selling: an Interpersonal influence Perspective. . *Journal of Marketing*, 68-81.

Cortina, J. M. (1993). What is Coefficient alpha? An examination of Theory and Applications. *Journal of Applied Psychology*, 78, 98-98.

Chu, K. M. ((2009)). The Construction Model of Customer Trust, Perceived value and Customer loyalty. . *Journal of American Academy of Business, Cambridge*, 14(2), 98-105

Crosby, L. A., & Cowles, D. ((1990)). Relationship quality in services selling: an interpersonal influence perspective. . *Journal of Marketing*, 68-81.

Davis, K. (1997). Presidential Address to the Association for Health Services Research: Uninsured in an Era of Managed Care.". *Health Services Research*, 31,No.6(641-49).

Davis, K., & D.Makuc. (1981, Jan.). "Acess to Health care for the Poor : Does the Gap Remain?". *Annual Review of Public Health*, pp. 159-82.

Donabedian, A. (2005). Evaluating the Quality of Medical Care. Vol. 83, No. 4 By Wiley on behalf of Milbank Memorial Fund.

Drew, B. ([2004]). The applicability of SERVQUAL in cross-national. *Journal of Services Marketing*, 524-533.

Davis, F. ( 1989, September (13:4)). Perceived Usefulness, Perceived Ease of Use, and

- User Acceptance of Information Technology," *MIS Quarterly*, pp. pp, 319-340
- Enthoven, A. (1980). Who wins, Who loses in the Transformation of America's largest Service Industry. *Journal of Health Politics ,Policy and Law*, 78-82.
- Epstein AM, L. T. ([2004]). Paying Physicians for High-quality care. *N. English Journal Medicen*, 350:406-410.
- Fitzpatrick, R. (1984). Satisfaction with Health care. In R. Fitzpatrick, *The Experience of Illness* (pp. P.154-75). London: Tavistock: Fitzpatrick R, edition.
- Fitzpatrick, R. (2009). The Importance of Patient Satisfaction in Surgery. *Journal of Surgery*, 438.
- Flemmings. (1995). Revisiting the Behavioral Model and Access to Medical Care: Does it Matter? *Journal of Health and Social Behavior*, 1-10.
- Foster, T. ., ([1995]). Comparing the Quality of Private and public hospital. *Managing ' Service Quality*, 290-299.
- Fornell, C., & Cha, J. (1994). Partial least sqaure Bagizzi,R.P(Ed.). In R. Bagizzi, *Advanced Methods of Marketing Research* (pp. pp.52-78). Blackwell : Oxford.
- Fornell, C., & Larcker, D. F. ((1981)). Structural Equation Models with Unobservable Variables and Measurement error: Algebra and statistics. *Journal of Marketing Research.*, 382-388.
- Garner, C., & Raudenbuch, S. (2012). Neighbourhoods and Potential Access to Healthcare:The role of spatial and aspatial Factors. *Health and Place*, 841-853.
- Gutek, B. A., Bhappu, A. D., Liao-Troth, M. A., & Cherry, B. (1999). Distinguishing

- between service relationships and encounters. *Journal of Applied Psychology*, 84(2),218.
- Gronroos, C. (1983). *Strategic Management and Marketing in the Service Sector*. Cambridge, MA: Marketing Science Institute.
- Grumbach, K., Vranizan, K., & Bindman, A. B. (1997). *Physician Supply And Access To Care In Urban Communities. Health Affairs*, 16(1), 71-86.
- GWB, S. (2009). Patient-Reported Outcome Measures :The importance of Patient Satisfaction in Surgery. *Journal of Surgery*, Vol.146 No.3 .
- Ghasemi, J., & Seifi, S. (2004). Preprocessing method for Partial Least Square in Simultaneous Determination of zinc and lead. Alanta.
- (Gordon et al., 2., Jackson, 2., & Saha, A. (2012). Patient Satisfaction Influenced by Interpersonal Treatment and Communication for African American. *American Journal of Men's Health*, 6-407.
- Garner, C., & Raudenbuch, S. (2012). Neighbourhoods and Potential Access to Healthcare: The role of spatial and aspatial Factors. *Health and Place*, 841-853.
- Gilbert T. (1995). Nursing: Empowerment and the Problem of Power. *Journal of Advanced Nursing*, 21 (5): 865-871
- Gremler, D. D. ((2000)). "Customer-Employee Rapport in Service Relationships,". *Journal of Service Research*,, 82-104.
- Gremler, D. D. ((2001)). Generating positive Word-of-mouth Communication through Customer-employee Relationships. *International Journal of Service Industry Management.*, 12(1), 44-59.



- Hall JA., D. M. (1990). Patient Sociodemographic Characteristics as Predictors of Satisfaction with Medical care: a meta Analysis. *Journal of Surgery*, 811-8.
- Haydar, A. A. (2007). Application of Fuzzy-neural System in the Analysis of the Relationship between Patient Satisfaction and Service Quality of Governmental Hospitals in TRNC”. *International Health and Hospital Administration Congress*, (pp. pp. 1459-66.). Near East University, Nicosia
- Headley, M. ([1993]). The applicability of SERVQUAL in cross-national. *Journal of Services Marketing*, 524-533.
- Healthcare In Cyprus. (n.d.). Retrieved June 30, 2013, from IPIN (International Property Investment Network) :<http://www.propertyshowrooms.com/cyprus/guide/healthcare-cyprus.asp>
- Hiscock, R. (2008). Is the Neighborhood Access to Health care Provision Associated with individual-level Utilization and Satisfaction? *Health services Research*, 43,2183-2200.
- Harrigan, J. A. (1983). Physicians’ Head and Body Positions as Determinants of Perceived Rapport,”. *Journal of Applied Social Psychology*,, 13 (November-December), 496-509.
- Herman, W. ( Vol .2 ,1982). The Basic Design and some extensions,. In H. W. K.-G. Joˆreskog, *Systems Under Indirect* (pp. 1-53). North-Holland Amsterdam.
- Hulland, J. (1999). Use of Partial Least Squares (PLS) in Strategic Management Research: a review of four recent studies. . *Strategic Management Journal*, 20(2), 195-204.
- Ian C. MacMillan. (1992). “A Catastrophe Model for Developing Service Satisfaction

Strategies". *Journal of Marketing*, 56 (6) 83-95.

J.E.Ware Jr., A. &. (2005). Measuring patient-centered Communication in Patient-Physician Consultations: Theoretical and practical issues. *Social Science & Medicine*, 1516-1528.

Jay H.Heizer, B. R. (2006). *Principles of Operations Management*. Prentice Hall.

Jeantrout, P. (1994). Influence of Experience on Service Expectations. *International Journal of Service Industry Management*, 172.

Johnson, C., & Mathews, B. P. (1997). The Influence and Experience on Service Expectations. *International Journal of Service Industry Management*, 290-305.

John, A., & Dana P, G. (2011). How Costly is Hospital Quality? A Revealed-Preference Approach. *The Journal of Industrial Economics*, Vol,59 PP 578-608.

Keizer, N. F. (2007). Evaluation of Outpatient Computerized Physician Medication order entry systems: a systematic review.*Journal of the American Medical Informatics Association*, 14(4), 400-406.

kirshnan, M. (1998). Customer satisfaction :the role of product,services and information technology. *Journal of Management Science* , 45.9.

Kong, R. &. (1996). Measuring service quality in the business-to-business Context. *Europeanl Journal of Marketing*, 8-32.

Korsch, G. &. (1977). *the Measurement and meaning of Patient Satisfaction:The Review of Literature*. Santa monica California 90406: The Rand corporation.

Kotler, P. ( 2003). *Marketing Management*. 11th edition.

- Kotler, P. (2000). Building Customer satisfaction, Value and Retention. In P. Kotler, *Marketing Management Millennium Edition* (pp. 33-37). Upper saddle river New Jersey: Prentice Hall Inc.
- Kotler, P. (2005 ). Understanding Market Place and Customer needs. In P. .. Kotler, *Principles of Marketing* (p. 7). Upper Saddle River, New Jersey: Prentice Hall 11th edition.
- Kotler, P. (2005). Institutional and Government. In P. Kotler, *Principles of Marketing* (p. pp.185). Upper State river New Jersey: Prentice Hall.
- kotler, P. (2005). The Company's Macroenvironment. In P. kotler, *Principles of Marketing* (p. 69). New Jersey: Prentice Hall.
- Kline, R. (2010). principles and practice of structural equation modeling(3th edition ). USA: A division of guilford publications.
- Kritzer, R. (1990). “*Rapport in Therapist-Client Interactions: An Ecological Analysis of the Effects of Nonverbal Sensitivity and Interactional Synchrony,*”. Hofstra university:doctoral thesis .
- Lawrence, A. c. (2004). "Manufacturing experiences". *Marketing Management*, pp.12-14
- Lee J, V. V. (2009). Patient-reported outcome measures:The importance of patient satisfaction in surgery. *Journal of Surgery*, 437.
- Lega, F. (2006). Developing a marketing function in public healthcare systems A framework for action. *Health Policy*, 78(2–3), 340–352.

- Locelock.J.E., & Roger.WSchmenner, R. (1992). Customer Satisfaction. In C. W.Buswell, *Service Quality in Leisure and Tourism 2002* (p. 84). Cambridge MA USA: CABI publishing.
- Lovelock, C. (1996). *Service Market. New Jersey: Prentice Hall.*
- Lovelock., & Christopher, H. (1991). *Service marketing(2nd edition b.)*. New Jersey: Hall Inc.
- M.Anderson, R. (1995). Revisiting the Behavioral Model and Access to Medical Care: Does it Matter? *Journal of Health and Social Behavior*, 1-10.
- Mackoy, S. (2011). The Relationship between service quality and Satisfaction on customer. *School of Doctoral Studies (european union)*.
- Macintosh, G. ((2002a)). Building Trust and Satisfaction in Travel counselor/client relationships.*Journal of Travel and Tourism Marketing*, 12 (4) , pp. 59–73.
- Marquis, M. S., Davies, A. R., & Ware Jr, J. E. (1983). Patient Satisfaction and change in Medical care Provider: a longitudinal study. *Medical Care*, 21(8), 821-829.
- Mayo, K. a. ( 1993). *International Journal of Service Industry Management* , 6.
- Millman, M. (1993). *Do HMOs Make a Difference?Access to Health care*. Rochester: Excellus Health Plan, Inc.
- Millman, M. (1993). Measuring access to Healthcare in Today's market. *Health Service Research*, 625-684.
- Mnagold, B., & Parasuraman et al. ([2010]). Private Healthcare Quality :applying a

ServQual model. *International Journal of health care Quality Assurance*, 658-673.

Nacy Folbre., B. W. (2003). A Migrant World of Services. Vol10, No.3.

Nancarrow, C., & Penn, S. ((1998)). Rapport in Telemarketing-mirror, mirror on the call?. *Marketing Intelligence & Planning*, 16(1), 12-21.

Newman, K. (2001). A Critical Assessment of Service quality Measurement in a high street retail Bank. *International Journal of Banking marketing* , Vol.19 No.3, pp.126-39.

Normann.K (2000). Physical attractiveness of the service worker in the moment of truth and its effects on customer satisfaction. *Journal of Retailing and Consumer Services*, 16(3), 216-226.

Nordenfelt, L. (1995). *On the Nature of Health*. second edition. Dordrecht: Kluwer.

Oliver. (1983). Determinans of Customer Satisfaction. *Journal of Marketing Research*, 492-504.

Parasuraman, A. (1988). "SERVQUAL: a multiple-item scale for measuring consumer perceptions of service quality. *Journal of Retailing*, Vol. 64 pp.12-40.

Parasuraman, A. a. ((1985)). A conceptual model of service Quality and its implications for future research. *Journal of Marketing*, Vol. 49, 41-50.

Parasuraman., e. a. (1985). The Relationship Between Service Quality and Satisfaction on Customer Loyalty in Malaysian Mobile Communication Industry. *School of Doctoral Studies -2011*, 33.

- Pask E. (1995). Trust: an Essential Component of Nursing Practice. *Implications For Nurse Education*, 15 (3): 190-195.
- Peters. (1988). *International Journal of Service Industry Management* .
- Pfaff. ([1982]). An Investigation into the determinants of Customer Satisfaction. *Journal of Marketing Research*, 491.
- Price, L. L. ((1999)). Commercial friendships: Service provider-Client Relationships in Context. *The Journal of Marketing*, 38-56.
- Ramsaran-Fowdar. ([2005]). Private Health care Quality applying a ServQual Model. *Journal of Health care Quality Assurance*, Vol,23 No 7.
- Rasmusson, E. ( 2000). Marketing more than a product. In *Sale and Marketing Management* (p. pp.99).
- Reichheld, F., & Teal, T. (1996). *The loyalty effect:the Hidden Force Behind Growth,Profits and Lasting Values*. USA: Hard Business School.
- Rodgers B. (1989). Concepts, Analysis and the Development of Nursing knowledge: the Evolutionary cycle. *Journal of Advanced Nursing*, 14 (4): 330-335.
- Rotter. (1975). *The Measurement and Meaning of Patient Satisfaction:The Review of Literature*. California: The Rand Corporation.
- Rust,R.T. and Oliver, R.L.(2001). *Some new thoughts on Conceptualizing Perceived Service Quality: a hierarchical approach*. *The Journal of Marketing*, 34-49.
- Schempf, A., & Kaufman, J. (2011). The Neighborhood Contribution to black-white

- Perinatal Disparities:an example from twoNorth. *American Journal of Epiidiomology*, 174. 744- 752.
- Sitzia, J., & Wood, N. (1997). Patient satisfaction: a review of issues and concepts. *Social Science & Medicine*, 45(12), 1829-1843.
- Smith, A. (1995). "Measuring service quality: is SERVQUAL now redundant?". *Journal of Marketing Management*, Vol. 32 pp.17-28.
- Stimson, & Webb, G. (2009). The importance of patient satisfaction in surgery *Journal of Surgery*, 437.
- Stremersch, S. (2008). Health and marketing: The Emergence of a new field of Research. *International Journal of Research in Marketing*, 25(4), 229–233.
- Stephen B. Castleberry, a. J. ((1992),). *Selling:Building Partnerships*. Homewood, IL: Richard D. Irwin.
- Thorpe, K. ( 1997). Market-Driven healthcare: Who Wins, Who Loses in the transformation of America's largest service industry. *Journal of Health Politics Policy and Law*, 22(6)1443-1448.
- Thorne S., R. C. (1989). Journal of Advanced Nursing care relationships. *Journal of Advanced Nursing*, 13 (6): 782-789.
- Thorpe. (1997). Who wins, Who loses in the transformation of America's largest service Industry. *Journal of health Politics ,Policy and Law*.
- Tickle-Degnen, L., & Robert, R. (1990). “The Nature of Rapport and Its Nonverbal Correlates,”. *Psychological Inquiry*, 1 (4), 285-93.

- Trojan, L., & Yonge, O. (1993). Developing Trusting, caring relationships: home care nurses and elderly clients. *Journal of Advanced Nursing*, 18 (12): 1903-1910.
- Van der Sande, M. (2000). "Servicing the soul", . *presentation at the Seventh Quality in Services Symposium*. University of Karlstad, Karlstad.
- Wallston k., w. B. (1997). Concept Analysis of Trust:a coronary care perspective. *Intensive and Critical Care Nursing*, 13,351-356.
- Ware Je Jr. (2009). Patient-reported outcome measures:The importance of patient satisfaction in surgery. *Journal of surgery*, vol 146 No.3.
- Ware Jr, J. E., Snyder, M. K., Wright, W. R., & Davies, A. R. (1983). Defining and Measuring Patient Satisfaction With Medical Care. *Evaluation and Program Planning*,6(3), 247-263.
- World Development Indicators (2003), World Development Indicators Indicators in CD Database,*World Bank Publications*, Washington, DC
- Zeithaml, C., & Dwanye, D. ((2006)). *Service Marketing:Integrating Customer Focus Across the Firm( 4th Edition b.)*. Boston,USA: McGraw-Hill/Irwin.
- Zeithaml, V., & Mary, J. ((2000)). *Service Marketing:Intergrating Customer Focus Across the firm(2th edition b.)*. USA: McGraw-Hill.
- Zeithaml, V. A., Berry, L. L., & Parasuraman, A. (1988). Communication and Control Processes in the Delivery of Service Quality. *The Journal of Marketing*, 35-48.



## **APPENDIX**

# QUESTIONNAIRES

## English Version

Please answer the following questions. No one will ever associate these responses with your name. Please circle or tick.

1 ☹	2	3 😐	4	5 ☺
Strongly Disagree	Disagree	Indifferent	Agree	Strongly Agree

Which source of care would you prefer if you had a personal injury that could be handled equally well by each of these sources of health care

I would prefer to go to a private clinic/hospital

I would prefer to go to my personal physician

I would prefer to go to the state hospital emergency

R1	This hospital fulfills its promises to meet patient's need.
R2	The hospital personnel can handle a problem in a very good and timely way.
R3	The hospital provides services at the promised date and time.
R4	The hospital maintains a secure data entry records.
Rs1	The hospital's personnel provide timely and regular information when services will be performed.
Rs2	The frontline personnel are prompt in providing services like reception, emergencies, diagnosis, and in solving other problems.
Rs3	The hospital personnel constantly and readily provide quality services to me
T1	This hospital is using modern, up to date technology and operating facilities.
T2	Equipment associated with services is visually appealing.
T3	This hospital's employee has a neat and professional appearance.
T4	This hospital ensures strict hygienic condition and cleanliness in every level.
T5	I am satisfied with the convenience of location.

T6	My doctor has equipment needed to provide complete care.
A1	This hospital's employees instill confidence in me.
A2	The reputation of this hospital is trustworthy and I always feel secure.
A3	This hospital's employees are always courteous and respect me as a customer.
E1	The personnel listen to me and use language that I can understand.
E2	The personnel in this hospital provide services relying mainly with customers best interests at heart.
E3	The hospital employees understand patient's specific needs and personal requirement.
E 4	The hospital working hours are appropriate to me.
Tr1	The billing system of this health care service is trustworthy.
Tr2	The policies, practices and reputation of this health care service are trustworthy.
Tr3	The service process provided by this hospital is secure.
St1	I am satisfied with the overall service quality offered by this hospital.
St2	I am satisfied with the professional competence of this health care provider.
St3	I am satisfied with the performance of the frontline employees of this health care service provider.
St4	I am satisfied with the cost provided for the services offered
L1	I intend to continue using these health care services for a long time.
L2	Even if other health care providers' price is lower, I am not willing to change my health care provider
L3	I am willing to say positive things about their services to other people.
L4	I will encourage friends and relatives to use same hospital.
Fa1	I feel confident when I go to the hospital for treatment.
Fa2	Employees recognize and call me by name.
Fa3	Employees know how to best serve me.
Fa4	Employees perform service correctly from the first time.
Fa5	I am comfortable as regards to the relationship I have with the health care personnel.
Rp1	Hospital employees easily communicate and collaborate with me.
Rp2	Employees work hard to build a strong relationship with me.
Rp3	Hospital employees put effort to solve customers' Complaints.
Rp4	Services offer by this hospital makes me feel special respected and welcome.
Rp5	Hospital employees create a trusting and harmonious relationship with me.
Fri1	I prefer to be served by the same hospital employees.
Fri2	I am satisfied with the Friendliness and Politeness of the employees.
Fri3	The hospital personnel/employees are always helpful to me in case of any problem.
Fri4	I care strongly about the employees.
Fri5	I look forward to meeting with the employees when I visit the hospital

Fri6	Employees have personal interest in me
Ca1	Doctors explain the side effect of drugs, check on allergies and gives advice
Ca2	Hospital employees focus on continuity of care.
Ca3	Doctors explain prescription, procedures and hold on patient's consent.
Ca4	Doctors support Patients values
Fri6	Employees have personal interest in me

### Demographic information

Your responses will only be used for aggregate survey analyses and we will treat them with the strictest confidentiality. Individual responses will not be given to anyone for any purpose. For each item, please provide answer that most closely describes you.

Gender     Male     Female

Age     Under 18     18 – 30     31-40     41-50     51-60     61 and above

Nationality:     Cypriot     Turkish    Others .....

City Of Resident: .....

Occupation: .....

Marital Status     Married     Single     Divorced    OTHERS .....

Education Level     Primary School     Secondary School     High School  
 Bachelors

Masters     Ph.D.

Monthly Personal Income Level (**Please Specify**)     1000TL and less

1000TL – 2000TL     2000TL – 3000TL     3000TL – 4000TL     4000TL –

6000TL     6000TL and more

**Turkish version.**

1 ☹	2	3 ☹	4	5 ☺
Kesinlikle Katılmam	Katılmam	FarkEtmez	Katılırim	Kesinlikle Katılırim

Herhangi bir rahatsızlığınız olduğunda, tüm kaynaklardan eşit şekilde bakım alacağınızı varsayarak aşağıda belirtilenlerden hangisine gitmeyi tercih ederdiniz:

- Özel klinik/hastaneye gitmeyi tercih ederdim.
- Kişisel doktoruma gitmeyi tercih ederdim.
- Devlet hastanesine gitmeyi tercih ederdim

R1	Hastane hastanın ihtiyaçlarını karşılamak için verdiği sözleri yerine getirir
R2	Hastane personeli bir problemi en iyi şekilde ve zamanında çözer
R3	Hastane hizmetlerini söz verilen tarih ve saatte sağlamaktadır.
R4	Hastanede kayıtlar güvenli tutulmaktadır.
Rs1	Personel sunulacak hizmet hakkında zamanında ve düzenli bilgi vermektedir.
Rs2	Hasta ile ilk temasa geçen (ön büro) personeli resepsiyon ve diğer sorunları da çözebilmektedir.
Rs3	Hastane personeli sürekli kaliteli servis sağlamaktadır.
T1	Bu hastanede modern, gelişmiş güncel teknoloji ve teçhizat mevcuttur.
T2	Hizmetle için kullanılan aletler vs. görsel olarak çekicidir.
T3	Hastane görevlileri düzgün ve tertipli bir görünüme sahiptir.
T4	Hastanede hijyen ve temizlik her seviyede sağlanmaktadır.
T5	Hastane konumunun uygunluğundan memnunum.
T6	Doktorum kontrol için gerekli bütün malzemelere sahiptir
A1	Hastane çalışanlara banı güven aşlamaktadır.
A2	Hastanenin itibarı güvenilirdir ve kendimi her zaman güvende hissedirim.
A3	Hastane çalışanları bana hasta olarak her zaman hürmetkâr ve saygılı davranır.
E1	Hastanedeki personel beni dinler ve anlayabileceğim bir dilde konuşur.

E2	Bu hastanede personel hastaya içten hizmet sunar.
E3	Hastane çalışanları hastanın belirgin ihtiyaç ve kişisel gereksinimlerini anlar.
E4	Hastanenin çalışma saatleri benim için uygundur.
Tr1	Bu sağlık hizmetinin faturalama sistemi güvenilirdir.
Tr2	Bu sağlık hizmetinin izlediği politika, uygulanaları ve itibarı güvenilirlidir.
Tr3	Hastane tarafından sağlanan hizmet süreci güvenilirdir.
St1	Bu hastane tarafından sağlanan hizmetten genel olarak memnunum.
St2	Bu sağlık hizmetindeki mesleki yeterlilikten tatminim.
St3	Bu sağlık kurumunda ön büro (ilk karşılaşılan) çalışanların sunduğu hizmetten tatmin oldum.
St4	Sunulan hizmetin maliyeti tatmin edicidir.
L1	Bu hastaneyi uzun süre kullanmaya niyetliyim.
L2	Diğer sağlık hizmeti sunan yerlerin fiyatları daha düşük olsa bile, kullandığım hastaneyi değiştirmeyi düşünmüyorum.
L3	Hastanenin hizmetleri hakkında başkalarına olumlu şeyler söylemeye istekliyim.
L4	Arkadaş ve tanıdıkları bu hastane hizmetlerini kullanmaya teşvik edeceğim.
Fa1	Hastaneye tedaviye gittiğimde kendimi güvende hissedirim.
Fa2	Hastane çalışanları beni tanır ve ismimle hitap eder.
Fa3	Hastane çalışanları bana en iyi nasıl hizmet edileceğini bilir.
Fa4	Çalışanlar sundukları hizmeti ilk defadan doğru yapar.
Fa5	Sağlık çalışanları ile rahat bir ilişki kurarım.
Rp1	Hastahane çalışanları benimle kolayca iletişim ve işbirliği kurar.
Rp2	Çalışanlar benimle sağlam bir ilişki kurmak için çaba sarfeder.
Rp3	Hastahane çalışanları hastaların şikayetlerini çözmede çok çaba harcarlar.
Rp4	Bu hastahane tarafından sunulan hizmetler bana kendimi özel hissettirir.
Rp5	Hastahane çalışanları benimle güven verici ve uyumlu bir ilişki kurar.
Fs1	Aynı hastane çalışanları tarafından hizmet almayı tercih ederim

Fs2	Çalışanların kibar ve arkadaş canlısı olmalarında memnunum.
Fs3	Hastane personeli/çalışanları karşılaştığım herhangi bir problemde bana her zaman yardımcı olurlar.
Fs4	Hastane çalışanlarına çok dikkat ederim.
Fs5	Hastaneye gittiğimde, personel ile görüşmeyi isterim/beklerim
Fs6	Hastane çalışanları beni mte kişisel olarak ilgilenir
Ca1	Doktorlar verdikleri ilaçların yan etkilerini açıklayıp, allerji kontrolü yaparlar ve tavsiyelerde bulunurlar.
Ca2	Hastahane çalışanları hasta bakımının devamlılığı üzerine yoğunlaşırlar.
Ca3	Doktorlar yazdıkları reçeteyi, yapılacak işlemleri hastanın onayına sunarlar.
Ca4	Doktorlar hastanın değer verdiği konulara dikkat ederler .

## DEMOGRAFİK BİLGİLER

Verdiğiniz bilgiler gizli tutulacaktır ve bu bilgiler toplu olarak analiz edilecektir.

Bireysel cevaplar herhangi bir şahsa herhangi bir sebeple verilmeyecektir. Her bir soru için, size en uygun seçeneği işaretleyiniz.

Cinsiyet: Bay Bayan

Yaş : 18'den Az 18 – 30 31-40 41-5051-60 61 Ve Üstü

Uyruk: Kkctc Tc Diğer: .....

Yaşadığı Yer : .....

Meslek: .....

Medeni Durumu : Evli Bekâr Boşanmış Diğer ...

Eğitim Durumu: İlkoku Ortaokul Lise Üniversite Master

Doktora

Aylık Maaşınız (Lütfen Belirtiniz): 1000tl Ve Altı 1000tl – 2000tl

2000tl – 3000tl 3000tl – 4000tl 4000tl – 6000tl  6000tl Ve Üzeri