

# **Near Field Focusing of Rectangular Microstrip Patch Antenna Array**

**Muhammad Sohail**

Submitted to the  
Institute of Graduate Studies and Research  
in partial fulfilment of the requirements for the degree of

Master of Science  
in  
Electrical and Electronic Engineering

Eastern Mediterranean University  
February 2016  
Gazimağusa, North Cyprus

Approval of the Institute of Graduate Studies and Research

---

Prof. Dr. Cem Tanova  
Acting Director

I certify that this thesis satisfies all the requirements as a thesis for the degree of Master of Science in Electrical and Electronic Engineering.

---

Prof. Dr. Hasan Demirel  
Chair, Department of Electrical  
and Electronic Engineering

We certify that we have read this thesis and that in our opinion it is fully adequate in scope and quality as a thesis for the degree of Master of Science in Electrical and Electronic Engineering.

---

Asst. Prof. Dr. Rasime Uygurođlu  
Supervisor

Examining Committee

---

1. Prof. Dr. Hasan Demirel

---

2. Prof. Dr. Abdullah Y. Öztoprak

---

3. Asst. Prof. Dr. Rasime Uygurođlu

---

## ABSTRACT

Near Field focusing is one of the most demanded current day research study. Microstrip patch antenna arrays are widely used for the purpose of focusing the radiation from an antenna in the near field (Fresnel) region. Several researchers are working to reduce the focused spot size and improve the power density within the focused region. A  $4 \times 4$  microstrip patch antenna array has been proposed here to be used as a near field focused array at a distance of  $800\text{mm}$  in the space with respect to the reference origin at frequency  $2.4\text{GHz}$ . A  $36\text{mm} \times 28\text{mm}$  inset fed microstrip patch antenna has been used, with dielectric substrate  $FR-4$ . The thickness of the substrate is  $1.6\text{mm}$ . Radiation from the antenna is focused at the focal point by providing each element with a different phase shift with respect to the reference point. The designed structure is a focused MPA array, having maximum radiation at  $350\text{mm}$  away from the aperture. The spot size at the point of maximum radiation is  $80 \times 120\text{mm}^2$ , while at the focal point the size of spot is  $260 \times 260\text{mm}^2$ . The structure is furthermore modified, in order to move the main beam of the focused field with variation in the frequency. The movement of the main beam is achieved by introducing extra lengths of microstrip lines which are multiples of wavelengths. The proposed structure is able to vary the position of main beam with variation in frequency.

**Keywords:** Microstrip patch antenna, near field, NFF antennas, phase distribution, return loss, E-Field radiation.

## ÖZ

Günümüzde, yakın alan odaklama konusu, en çok talep edilen mikrodalga araştırma konularından biridir. Mikroşerit yama anten dizileri, anten ışınlarının yakın alan odaklaması için yaygın olarak kullanılmaktadırlar. Birçok araştırmacı, odaklanan bölgenin boyutunu azaltmak ve odaklanmış bölgedeki güç yoğunluğunu artırmak için çalışmalar yapmaktadır. Bu çalışmada,  $2.4GHz$  frekansında, besleme referans noktasından  $800mm$  uzaklıktaki alana odaklanan, bir mikrodalga yama anten dizisi önerilmiştir. Gömme mikroşerit besleme ile beslen  $36 \times 28mm$  boyutlarındaki antenin alt tabakasında FR-4 kullanılmıştır. Alt tabaka kalınlığı  $1.6mm$  olarak alınmıştır. Anten radyasyonunun belli bir bölgede odaklanmasını sağlamak için, dizideki her eleman için bir referans noktasına göre faz kayması uygulanmıştır. Faz farkı, bireysel antenlerin radyasyonunun uzayda, yakın alan bölgesindeki bir noktada odaklanmasını sağlamaktadır. Tasarlanan anten,  $350mm$  mesafede  $80 \times 120mm^2$  boyutundaki alanda maksimum radyasyona sahip, odak noktasında ise  $260 \times 260mm^2$  alanda odaklanan bir mikroşerit yama dizi antendir. Tasarım, frekans değişimi ile odak alanını hareket ettirmek amacıyla, geliştirilmiştir. Ana hüzmelerin hareketi, mikroşerit hatlara dalgaboyunun katları olan hatlar ilave edilerek elde edilmiştir ve bilgisayar benzetim teknolojisi ile teori başarı ile test edilmiştir.

**Anahtar Kelimeler:** Mikroşerit yama anten, yakın alan, NFF antenler, faz dağılımı, geri dönüş kaybı, E-alanı, ışın eğrisi.

## **ACKNOWLEDGEMENT**

All the glories are to ALLAH, for making me able to achieve this milestone. I would like to acknowledge the support of my family, my friends and my respected teachers for helping me out in this regard.

I am extremely thankful to my supervisor Asst. Prof. Dr. Rasime Uygurođlu and Prof. Dr. Abdullah .Y. Öztoprak for driving me throughout the period of my thesis. I do not think I would be able to finish it in time without their help and support. They always forced me get the things right. I am honoured to be their student and I will try my best not to let their expectations down in future as well.

MIKA team, I am honored to be working with you, and bundle of thanks to Mr. Cemal Kılıç for giving me such an environment to focus on my studies.

# TABLE OF CONTENTS

ABSTRACT .....	iii
ÖZ .....	iv
ACKNOWLEDGEMENT .....	v
LIST OF TABLES .....	ix
LIST OF FIGURES .....	x
LIST OF SYMBOLS & ABBREVIATIONS .....	xii
1 INTRODUCTION .....	1
1.1 Thesis Objective .....	2
1.2 Thesis Contribution .....	2
1.3 Thesis Organization.....	2
2 ARRAY ANTENNAS .....	4
2.1 Antenna .....	4
2.2 Antenna Fundamentals .....	4
2.2.1 Radiation Pattern.....	4
2.2.2 Directivity .....	5
2.2.3 Gain.....	5
2.2.4 Bandwidth.....	6
2.2.5 Antenna Impedance .....	6
2.2.6 VSWR.....	6
2.2.7 Polarization .....	7
2.2.8 Antenna Efficiency .....	7
2.3 Array Antenna .....	7
2.4 Geometrical Configurations .....	9

2.4.1 Linear Array.....	9
2.4.2 Direction of Maximum Radiation.....	12
2.4.3 Directional Array .....	13
2.4.4 Broad Side Array .....	14
2.4.5 End Fire Array .....	15
2.5 Planar Antenna Array .....	16
2.5.1 Array Factor of Planar Array .....	16
2.6 Phased Arrays.....	19
2.6.1 Radiation Pattern of Linear Phased Arrays.....	19
2.6.2 Near Field Focused Arrays .....	21
<b>3 MICROSTRIP PATCH ANTENNA .....</b>	<b>23</b>
3.1 Microstrip Patch Antenna.....	23
3.2 Geometries of Basic Microstrip Patch Antennas.....	24
3.3 Feeding Techniques.....	26
3.3.1 Co-axial Feed.....	26
3.3.2 Microstrip Line Feed .....	27
3.3.3 Aperture Coupling Feed.....	28
3.3.4 Proximity Feed.....	29
3.4 Analysis of Microstrip Patch Antenna .....	30
3.4.1 Transmission Line Model .....	31
3.4.2 Geometrical Parameters of MPA.....	32
<b>4 MICROSTRIP PATCH ANTENNA ARRAY .....</b>	<b>36</b>
4.1 Microstrip Patch Antenna Array .....	36
4.2 Array Arrangement.....	36
4.3 Feeding Networks.....	37

4.3.1 Series Feed Network.....	38
4.3.2 Parallel Feed Networks.....	38
4.3.3 Microstrip T-Junction, Power Divider.....	41
4.3.4 Microstrip Bends.....	42
5 DESIGNS, SIMULATION RESULTS AND DISCUSSION .....	44
5.1 Design Structure .....	44
5.2 Single Element Microstrip Patch Antenna .....	44
5.2.1 Single Element RMPA Results.....	45
5.2.2 Return Loss .....	45
5.2.3 Far-Field Radiation Pattern.....	46
5.3 4*4 Rectangular Microstrip Patch Antenna Array .....	47
5.3.1 Microstrip Lines.....	48
5.3.2 T-Junction .....	49
5.3.3 Mitred Bend .....	49
5.3.4 Array Elements Phase Distribution.....	50
5.3.5 4*4 Rectangular Microstrip Patch Antenna Array Results.....	51
5.3.6 Return Loss .....	51
5.3.7 Normalized Electric Field.....	52
5.4 Results Comparison.....	55
5.5 Shifting of Main Beam by Frequency Variation .....	56
5.5.1 Results.....	58
6 CONCLUSION AND FUTURE WORK.....	61
REFERENCES.....	62



## LIST OF TABLES

Table 1: Summary of the simulation results .....	47
Table 2: Phase distribution of 4*4 array .....	51
Table 3: 4*4 Array antenna parameters .....	55
Table 4: Comparison .....	56

## LIST OF FIGURES

Figure 1: Uniform linear antenna array [7] .....	10
Figure 2: A typical radiation pattern [7] .....	12
Figure 3: Broad side linear antenna array .....	14
Figure 4: Broadside array with two isotropic point sources .....	15
Figure 5: End fire array .....	15
Figure 6: End fire and broad side antenna arrays [7] .....	16
Figure 7: Radiation pattern of an 8*6 rectangular antenna array [8] .....	18
Figure 8: Basic linear phased array .....	20
Figure 9: Beam steering concept with phase shifters [8] .....	21
Figure 10: Near field focused planar array [11] .....	22
Figure 11: Basic microstrip patch antenna .....	24
Figure 12: Co-axially fed rectangular MPA [8] .....	27
Figure 13: Microstrip line feed .....	28
Figure 14: Inset feed .....	28
Figure 15: Aperture coupling feed [7] .....	29
Figure 16: Proximity coupled feed [7] .....	30
Figure 17: Microstrip line [8] .....	31
Figure 18: Electric field lines [8] .....	32
Figure 19: Microstrip patch antenna [8] .....	33
Figure 20: Top view of the patch antenna [8] .....	33
Figure 21: Side view of the patch antenna [8] .....	34
Figure 22: (a) Linear MPA array and (b) Planar MPA array .....	37
Figure 23: Series fed MPA linear array .....	38

Figure 24: Parallel (Corporate) fed MPA array .....	39
Figure 25: Microstrip line .....	40
Figure 26: T-Junction power divider.....	41
Figure 27: Microstrip mitred bend .....	43
Figure 28: Rectangular microstrip patch antenna .....	45
Figure 29: Return loss of rectangular microstrip patch antenna .....	46
Figure 30: 3-D Far-field plot.....	46
Figure 31: Rectangular microstrip patch antenna array .....	48
Figure 32: 2-Element sub array.....	49
Figure 33: Mitred bend.....	50
Figure 34: Return loss .....	52
Figure 35: Normalized E-field plot.....	53
Figure 36: Normalized E-field at z=350 mm.....	54
Figure 37: Normalized E-field at z=800 mm.....	54
Figure 38: Design structure.....	57
Figure 39: E-Field at 2.2 GHz.....	58
Figure 40: E-Field at 2.4 GHz.....	59
Figure 41: E-Field at 2.45 GHz.....	59
Figure 42: E-Field at 2.5 GHz.....	60

## LIST OF SYMBOLS & ABBREVIATIONS

$\lambda$	Wavelength
$\Omega$	Ohm
$\varepsilon$	Epsilon
$\varepsilon_r$	Relative Permittivity
$L_{eff}$	Effective Length
$\Sigma$	Summation
AF	Array Factor
CST	Computer Simulation Technology
EM	Electromagnetic
FR-4	Flame Retardant 4
GPS	Global Positioning System
MMIC	Monolithic Microwave Integrated Circuit
MPA	Microstrip Patch Antenna
NFF	Near Field Focused
NF	Near Field
PCB	Printed Circuit Board
RFID	Radio Frequency Identification
SSL	Side Lobe Level
TEM	Transverse Electromagnetic
VSWR	Voltage Standing Wave Ratio

# Chapter 1

## INTRODUCTION

With the advancement in technology and the discovery of compact and integrated circuits devices, microstrip patch antenna has been a key area of research from last few decades. It is because of their advantages such as less weight, low power handling capability, compatibility with Monolithic Microwave Integrated Circuit (MMIC) technology and the adoptability to be used in rigid surfaces. Near field focusing is one of the key problems of modern day applications such as medical, military and civil applications as well. In most of the cases, for instance in Medical applications, where the field from the antenna has to be focused at a certain point on the human body to detect or diagnose the affected tissues. For such applications, the conventional large and bulky antenna cannot be used. Microstrip patch antenna arrays are widely used for these applications due to their conformal nature.

In the early stages of near field focused (NFF) antenna arrays, focal lenses were kept in front of array structure, to get the radiated power focused at certain point [1-2]. In microwave remote sensing, the resulting beam is supposed to be much focused in order to get precise sensing [3]. In bio medics Microwave Induced Hypothermia is a technology [4], where all the radiated microwave energy is focused at a certain point to heat up the desired unhealthy region of the human body. Other than that, Radio Frequency Identification (RFID) systems are using the beam to focus in the near-field region [5]. In [6] a NFF arrays has been designed for controlling the gate

access, where the aim is to focus the radiation at a certain region of focal point and outside that region the magnitude of the power decay very quickly to avoid contacting the areas of non interest.

## **1.1 Thesis Objective**

The objective of this thesis is to design a  $4 \times 4$  rectangular microstrip patch antenna Array, which would be able to focus the radiation in a region of interest in the near field.

## **1.2 Thesis Contribution**

To achieve the near field focused MPA array, a quadratic phase distribution is applied to the array. With respect to the reference point each element in the array receives power with different phase shift as compared to other elements. The difference in the phase shift creates a time difference between the elements to radiate and hence focusing the radiation at a certain point in the near field.

## **1.3 Thesis Organization**

Chapter 1 of the thesis provides an overview of the thesis. In Chapter 1 the need of near field focused (NFF) arrays are explained with their application areas, where they are being used. Chapter 2 provides a detail study about the basics of antenna as well as antenna arrays. This chapter gives an insight of the fundamental elements of the antennas and antenna arrays. Microstrip patch antenna has been the key topic discussed in Chapter 3. The need of such antennas, their application perspective and the method of analysis of MPA are discussed in this chapter. To be more focus towards the thesis objective, Chapter 4 provides a conceptual study about microstrip patch antenna arrays, their basic building blocks and their use as near field focusing arrays. The simulated design of a single element microstrip patch antenna as well as a  $4 \times 4$  microstrip patch antenna array has been discussed in Chapter 5. The results

of the designed antennas can be found here as well. Chapter 6 is composed of the conclusion and future work, which would be carried out.

## Chapter 2

### ARRAY ANTENNAS

#### 2.1 Antenna

IEEE the Institute of Electrical and Electronics Engineers has defined antenna as “a source of radiating or receiving electromagnetic waves” [7]. It is a structure which separates a guided medium from an unguided medium. A guided medium can be a transmission line while unguided medium means space. Depending upon the electromagnetic energy, whether the energy is transported to or transported in to the antenna. If the energy is transported into the antenna, the antenna is a receiving antenna. If the energy is transported from the antenna, the antenna can be named as a receiving antenna.

#### 2.2 Antenna Fundamentals

Antenna is the basic fundamental block of wireless communication and wireless transmission. There are several parameters which describes the characteristics of an antenna. Some of the basic antenna parameters are given below;

##### 2.2.1 Radiation Pattern

Radiation pattern is one of the important and basic parameter of an antenna. For transmission and reception of electromagnetic energy, there should be transmitting and receiving antennas. Whenever an antenna receives a power at a certain point, it depends upon the position of the receiving antenna with respect to the transmitting antenna. When the power from the transmitting antenna at a constant radius is plotted, it is known as “power pattern” [7]. This pattern is a spatial pattern. The



spatial pattern of electric or magnetic field at a certain plan is called radiation pattern in that plane.

### 2.2.2 Directivity

The ratio of the radiation intensity of an antenna in the direction, where antenna has maximum radiation, to the average radiation of the antenna [7]. If  $(\theta, \phi)$  is the direction in which the maximum radiation occurs and the radiation intensity in the direction of maximum radiation is denoted by  $U_{\max}(\theta, \phi)$ , the directivity  $D$  of an antenna can be illustrated as;

$$D = \frac{4\pi U_{\max}(\theta, \phi)}{\int U(\theta, \phi) d\Omega} \quad (2.1)$$

Where  $d\Omega$  is the unit solid angle and is always equal to  $\sin\theta d\theta d\phi$ . The whole term  $\int U(\theta, \phi) d\Omega$  in the denominator is usually denoted as  $P_{rad}$ . The updated equation is;

$$D = \frac{4\pi U_{\max}(\theta, \phi)}{P_{rad}} \quad (2.2)$$

### 2.2.3 Gain

Gain of an antenna can be defined as the ratio of the maximum radiation intensity of an antenna compared to the maximum radiation intensity of a standard reference antenna [7], with equal amount of input power. Most of the time, the reference antenna is taken as an isotropic antenna and in that case the gain of the antenna is known as absolute gain of the antenna. If the reference antenna is different from an isotropic antenna, then it should be mentioned along the gain of the antenna, that the gain of antenna calculated is compared with dipole, monopole antenna etc. The antenna gain can be mathematically stated as;

$$G = \frac{4\pi U_{\max}(\theta, \phi)}{P_{in}} \quad (2.3)$$

In terms of the directivity, the gain of an antenna  $G$  can be defined as the efficiency  $\eta$  time's directivity  $D$  of an antenna.

$$G = \eta \times D \quad (2.4)$$

For an antenna having 100% efficiency, the gain will be equal to the directivity.

#### 2.2.4 Bandwidth

Bandwidth of an antenna is a very key parameter to check the performance of an antenna. Bandwidth of an antenna can be defined as the range of frequencies for which the return loss of an antenna is less than  $-10dB$ . This limit is a standard for all antennas. Any antenna having return loss less than that limit is considered as an efficient antenna as compared to antennas having return loss higher than  $-10dB$ .

#### 2.2.5 Antenna Impedance

The impedance of an antenna can be defined as the impedance of the structure terminals where no load is connected to the antenna. The impedance is actually the ratio of voltage to current at a terminal.

#### 2.2.6 VSWR

VSWR also called as Voltage Standing Wave Ratio is a function of reflection coefficient of an antenna. It shows that what amount of power is absorbed at the load and how much power is reflected back from the antenna structure [7].

Mathematically;

$$VSWR = \frac{1 + |\Gamma|}{1 - |\Gamma|} \quad (2.5)$$

where,  $\Gamma$  is the reflection coefficient. The ideal value of  $VSWR$  is 1. The minimum value of voltage standing wave ratio for an acceptable antenna is 2.

### **2.2.7 Polarization**

Polarization of an antenna can be defined as the orientation of the electromagnetic fields. There are two types of basic polarization, with reference to the earth surface. Vertical polarization and horizontal polarization. If the antenna is designed to have either vertical or horizontal polarization, the antennas are said to be linearly polarized. While the polarization of an antenna would be elliptical, if it has two orthogonal components with some phase difference between them. When the phase difference between the components is  $\pm 90^\circ$  with equal amount of magnitude, the polarization can be defined as circular polarization [7].

### **2.2.8 Antenna Efficiency**

Efficiency of the antenna is a transformation function of the input power of the antenna to the radiation power. The efficiency of the antenna is determined by the amount of the input power to be radiated from the antenna [7]. A highly efficient antenna will radiate most of the power as a radiation while it may have some dissipated power as well. A 100% efficient antenna radiates all the power that is received at the input terminal of the antenna. Mathematically;

$$\eta = \frac{P_{rad}}{P_{in}} \quad (2.6)$$

where  $P_{rad}$  is the power radiated by the antenna and  $P_{in}$  is the input power of the antenna.

## **2.3 Array Antenna**

The arrangement and interconnection of more than one antenna in a particular way to get a radiation pattern directed in a specific direction is called Antenna Array. Each antenna within the array is called as an element of the array. Several applications require the radiation pattern of a single element antenna to be more directive and

radiate more power. With a single element antenna it is not possible, hence antenna array is used to achieve such a requirement. Usually, we have more than one antennas and a feed network, which is used as an interconnection between elements of the array. This is the feed network through which each element of the array is excited. The versatility of an antenna array is that if the excitation current's phase is changed from element to element within the array, it is observed that the main lobe of the radiation pattern can be moved in the space. This practice is called as beam scanning, and the array would be called as Phased Array. Phased Arrays are very popular in current day's applications such as medicine, radar, robotics etc.

An array of identical elements is considered. There are several factors which control the overall radiation pattern of the array. The radiation pattern resulted from an array antenna is highly dependent upon the single element that is used within the array [8]. If the array is formed by using dipole antennas, the overall radiation pattern will follow the radiation pattern of the single element used, irrespective of the fact which geometrical configuration is followed (Linear, Planar, Circular, etc.). The distance between the adjacent elements should be equal; otherwise the overall radiation pattern might not be what is expected. The excitation signal amplitude and phase is very important. It is possible to have single elements having same excitation amplitude and phase or it can be different. It depends upon the application of the user.

The basic antenna array concept can be explained in two parts i.e. *element pattern*, corresponds to the pattern of individual element with in the array and *array factor*, corresponds to the array geometry and the element excitation. To make it easy and understandable, let us consider an array having an overall radiation pattern. The

overall radiation pattern is the combination of the single element radiation patterns. For instance, each single element in the array is replaced with a point source radiating isotropically. In this case the radiation pattern as a result would be array factor. Hence, the total resulting pattern of the array is actually the multiplication of element pattern and array factor. The phenomenon is called as pattern multiplication.

## **2.4 Geometrical Configurations**

The configuration in which the elements of the antenna are arranged plays an important role in combining the power radiated by a single element. Before going to form an array one must keep in mind about arrangement in which the elements should be placed. There are several geometrical configurations of antenna array, but mainly the literature are focused around two types of geometrical configurations [8], given as follows;

- Linear Array
- Planar Array

### **2.4.1 Linear Array**

The arrangement of identical antenna elements, in which all the elements are having same orientations i.e. along a straight line, is called a Linear Array [8]. The radiation of individual elements is coherently combined to form an overall radiation pattern in the space around array.

The line or the orientation in which the antennas are placed is known as “axis of the array”. The relative displacement between two adjacent elements is an arbitrary distance in general, and each element can be excited with different or same excitation currents and phases. If a linear array is excited with same amplitude and phase, it is called as “Uniform Linear Array”.

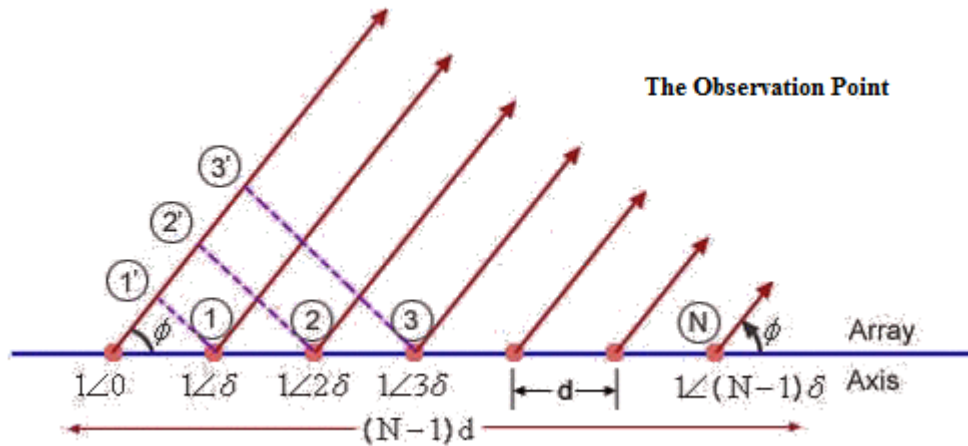

Figure 1: Uniform linear antenna array [7]

In Figure 1, an  $N$  identical element array having equal spacing between the adjacent elements, with uniform excitation current is presented. The phase shift between every two adjacent elements is taken equal. The elements of the array are chosen to be isotropic.  $d$  is the inter element spacing while  $\delta$  is the phase shift between two adjacent elements of the array. Usually the first element is chosen to be the reference element as it is shown by Figure 1.

When we are talking about field due to a single antenna, it is proportional to the current of that antenna. At far away point, only the phases are different, the magnitude remains same for the single element. Before talking about the total phase difference, let us examine the phase here. The phase has two components, one depends upon the excitation current and the second component is due to the propagation. The phase difference due to propagation would be equal  $\cos\phi$ , where  $\phi$  is the angle made by the observation point  $P$ , which is in the direction of axis of the array.

The sum of all the phase differences of the current and propagation of the fields due to adjacent elements [8] is given by equation (2.7);

$$\Psi = \beta d \cos \theta + \delta \tag{2.7}$$

To find the total field, we have to take some assumptions;

- The first element of the array is the reference element.
- The amplitude of the single element is supposed to be unity at the point of observation.

As the first element of the array is chosen to be the reference element, the field should have zero phase. At observation point the expression for total field will be;

$$E = e^{j0} + e^{j\Psi} + e^{j2\Psi} + e^{j3\Psi} + e^{j4\Psi} \dots\dots\dots + e^{j(N-1)\Psi} \tag{2.8}$$

$$Ee^{j\psi} = e^{j\Psi} + e^{j2\Psi} + e^{j3\Psi} + e^{j4\Psi} \dots\dots\dots + e^{jN\Psi} \tag{2.9}$$

Equation (2.9) gives rise to,

$$E = \frac{1 - e^{jN\Psi}}{1 - e^{j\Psi}} \tag{2.10}$$

Simplifying and taking magnitude of equation (2.10),

$$E = \frac{\sin\left(N \frac{\Psi}{2}\right)}{\sin\left(\frac{\Psi}{2}\right)} \tag{2.11}$$

When all the terms in series add up with the same phase, the maximum field can be obtained i.e. for  $\psi=0$ . Let N, be the maximum value of the field. When the radiation pattern is normalized with respect to its largest value N, the **Array Factor (AF)** is obtained.

$$E = \frac{1}{N} \frac{\sin\left(N \frac{\Psi}{2}\right)}{\sin\left(\frac{\Psi}{2}\right)} \tag{2.12}$$

Where,  $\psi = \beta d \cos \phi + \delta$ . Array Factor AF can be defined as a combination of N number of identical antenna having same orientation and a similar pattern. The main factor to define an Antenna Array is AF. Hence the Array Factor depends on  $\psi$ , while  $\psi$  itself is a function of  $\phi$ .  $\phi$  is always in the real space i.e.  $\phi \geq 0$  while the angle  $\psi$  is not necessary to be in the real space. Its value can be less than zero. In such cases the grating lobes problem arises. equation (2.12) is the general expression for a uniform array radiation pattern.

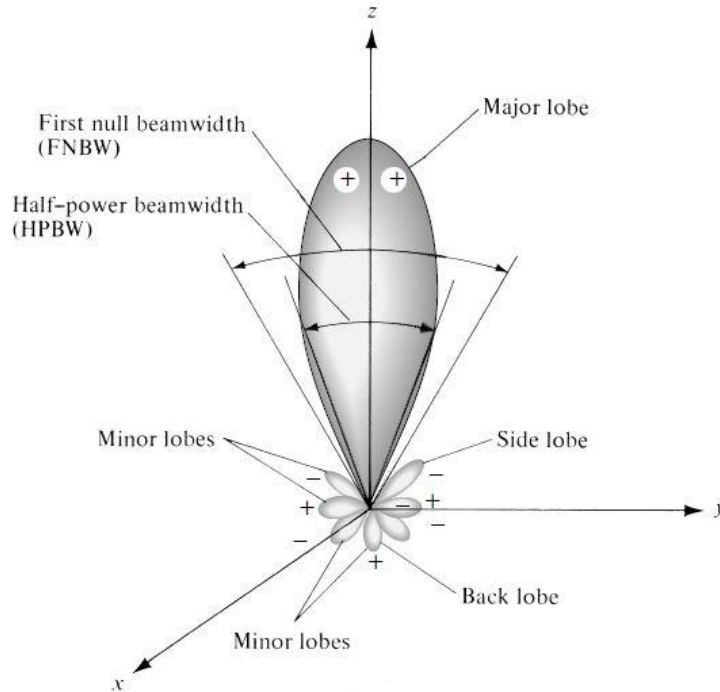

Figure 2: A typical radiation pattern [7]

#### 2.4.2 Direction of Maximum Radiation

Direction of the maximum radiation refers to the main beam of the radiation pattern. It is the most important factor of the array. As it was already discussed, the maximum radiation is obtained, when  $\psi=0$ . Where  $\psi$  is given by;

$$\Psi = \beta d \cos \theta + \delta \quad (2.14)$$



In case of maximum radiation, the direction of the radiation i.e.  $\phi$  would be replaced by  $\phi_{\max}$ .

$$\beta d \cos \theta + \delta = 0 \quad (2.15)$$

Hence,

$$\cos \phi_{\max} = -\frac{\delta}{\beta \times d} \quad (2.16)$$

$$\phi_{\max} = -\cos^{-1} \left( \frac{\delta}{\beta \times d} \right) \quad (2.17)$$

$$\phi_{\max} = -\cos^{-1} \left( \frac{\delta \times \lambda}{2 \times \pi \times d} \right) \quad (2.18)$$

It is very much clear from the above equation that the number of element has no role in deciding the direction of the maximum radiation of the array. Furthermore, if the progressive phase shift  $\delta$  is varied between  $-\beta d$  to  $+\beta d$ , we can vary the direction of the maximum radiation from 0 to  $\Pi$ .

Based on the radiation pattern, an antenna array is usually of two types;

- Directional Array
- End Fire Array
- Broad Side Array

### 2.4.3 Directional Array

The arrays can be categorized as directional arrays as antenna with fixed directional beam or antennas with electrically or mechanically steered beam. An array with fixed beam pointing is the simplest form of directional arrays as it provides a higher (in comparison with omnidirectional) gain and lower side lobe levels. A more complicated form of directional arrays is, array with a narrow beam that is steered in

a certain angle or direction. Such antenna arrays are not simple as compared to fixed beam arrays, as they require a special electrical or mechanical control to steer the beam in a certain direction.

#### 2.4.4 Broad Side Array

One of the most practical antenna array, in which elements of the array are placed parallel to each other and the maximum radiation is in the direction, perpendicular to the axis of the array i.e.  $\theta=90^\circ$  [8].

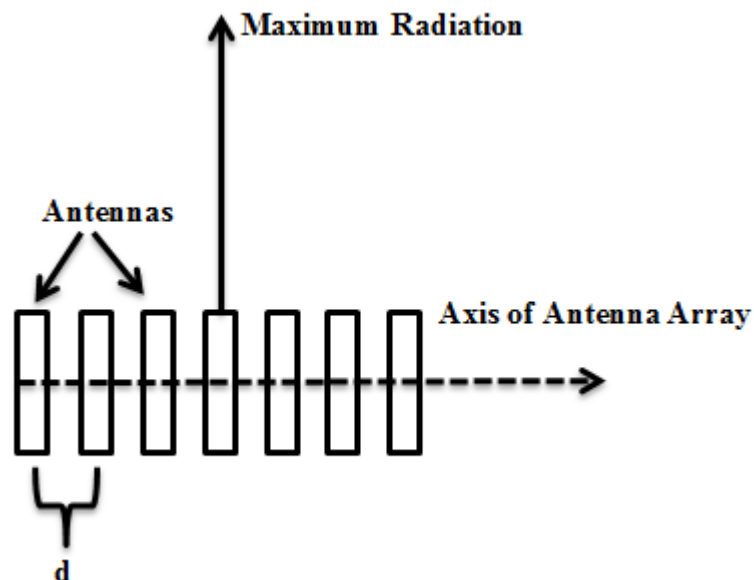

Figure 3: Broad side linear antenna array

It can be clearly observed from Figure 3 that a broadside array have all the elements along a straight line and the direction of maximum radiation is perpendicular to the axis of each single element. The spacing between adjacent elements is “d”, while the excitation current has same amplitude and phase for all elements in the array. The radiation pattern is along broadside and bidirectional normally.

Consider a broadside array having 2 elements spaced equally along a straight line. Suppose the elements are isotropic point sources, fed with equal amplitude and phase. Consider a point “P” away from the origin with distance “r” from the reference element. The wave radiated by antenna A1 will reach the point of observation early than antenna A2. The reason for this is the path difference between each element and the point of observation.

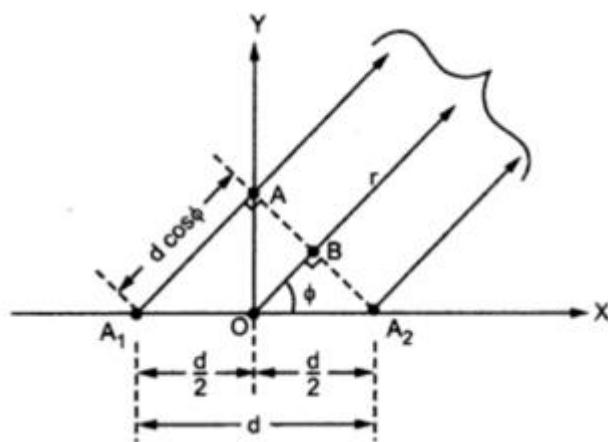

Figure 4: Broadside array with two isotropic point sources

### 2.4.5 End Fire Array

The array is said to be an end fire array, if the maximum radiation of array has same direction, as the direction of axis of the array [8]. In short at angles,  $\theta=0^\circ$ ,  $\theta=180^\circ$ . Sometimes it may be required that the direction of radiation should be only either at  $\theta=0^\circ$  or  $\theta=180^\circ$ .

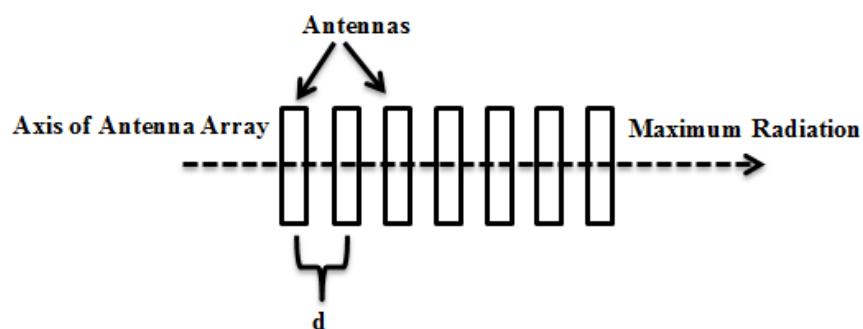

Figure 5: End fire array

The Broadside and End fire array's radiation pattern can be shown as in Figure 6;

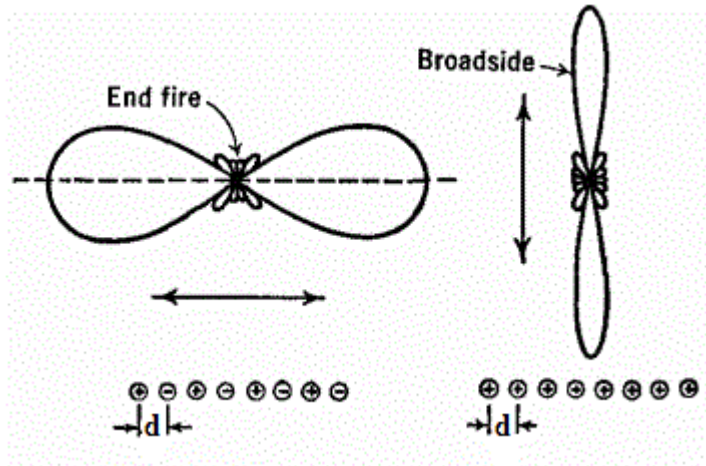

Figure 6: End fire and broad side antenna arrays [7]

## 2.5 Planar Antenna Array

Such an array in which, the elements are arranged in two dimensions in a plane is known as planar antenna array. (rectangular, square etc.). Consider an N-element linear array along the x-axis, if we extend another N-element linear array same as the first one along the y-axis, the arrangement can be termed as a planar array. If the number of elements in both the axis is same, the array can be called as square planar antenna array. If number of element in x-axis is different to that of y-axis, the array is said to be a rectangular planar array. Planar array has two significant advantages over the linear array, as planar array has more symmetrical pattern with reduced side lobes and it is more efficient in terms of beam scanning at a point in the space. Furthermore, the directivity of planar array is much higher (narrow beam) as compared to the directivity of a single element.

### 2.5.1 Array Factor of Planar Array

Consider an  $M \times N$  rectangular antenna array. The array factor of an  $M \times N$  rectangular array is given by;

$$A.F(\theta, \phi) = \sum_{m=0}^{M-1} \sum_{n=0}^{N-1} I_{mn} z_x^m z_y^n \quad (2.19)$$

Where,  $I_{mn}$  is the excitation current to the element in  $m^{th}$  row and  $n^{th}$  column.

Similarly;

$$Z_x = e^{j\beta d_x \sin\theta \cos\phi} \quad (2.20)$$

and

$$Z_y = e^{j\beta d_y \sin\theta \sin\phi} \quad (2.21)$$

Where  $d_x$  and  $d_y$  are the distance between the elements in x and y direction respectively. Let, the array is uniform planar array, with uniform excitation. Then the Array Factor becomes;

$$|A.F(\theta, \phi)| = \left| \frac{1}{M} \frac{\sin\left(\frac{M\Psi_x}{2}\right)}{\sin\left(\frac{\Psi_x}{2}\right)} \right| \left| \frac{1}{N} \frac{\sin\left(\frac{N\Psi_y}{2}\right)}{\sin\left(\frac{\Psi_y}{2}\right)} \right| \quad (2.22)$$

Where,

$$\Psi_x = \beta d_x \sin\theta \cos\phi + \delta_x \quad (2.23)$$

$$\Psi_y = \beta d_y \sin\theta \sin\phi + \delta_y \quad (2.24)$$

Here,  $d_x$  and  $d_y$  plays a critical role. If the value of  $d_x$  and/or  $d_y$  is greater than the wavelength, certain grating lobes are created. The reason for creation of these grating lobes is that the radiation fields that are in phase sum up to each other in more than one direction. Usually for an  $M \times N$  rectangular antenna array the main lobe and grating lobes occurs at;

$$\Psi_x = \pm 2\pi m \quad \Psi_y = \pm 2\pi n \quad (2.25)$$

Where  $m$  and  $n = 0, 1, 2, 3, \dots$ . From equations (2.23), (2.24) and (2.25) the direction for the grating lobes  $\theta_{mn}, \phi_{mn}$  is;

$$\tan \phi_{mn} = \left[ \frac{\sin \theta_0 \sin \phi_0 + \frac{n\lambda}{d_y}}{\sin \theta_0 \cos \phi_0 + \frac{m\lambda}{d_x}} \right] \quad (2.26)$$

$$\sin \theta_{mn} = \left[ \frac{\sin \theta_0 \sin \phi_0 + \frac{n\lambda}{d_y}}{\sin \phi_{mn}} \right] \quad (2.27)$$

The main lobe will occur at  $\theta=0$  and  $\phi=0$ , which is supposed to happen with  $m=0$  and  $n=0$ . In Figure 7 the radiation pattern of a rectangular array antenna is shown, having  $d_x = d_y = \lambda$  and  $\delta_x = \delta_y = 0$ . Due to the large spacing between the adjacent elements, grating lobes at  $\theta = \frac{\pi}{2}$  and  $\phi = 0, \frac{\pi}{2}, \pi, \frac{3\pi}{2}$  are created along with the main lobe.

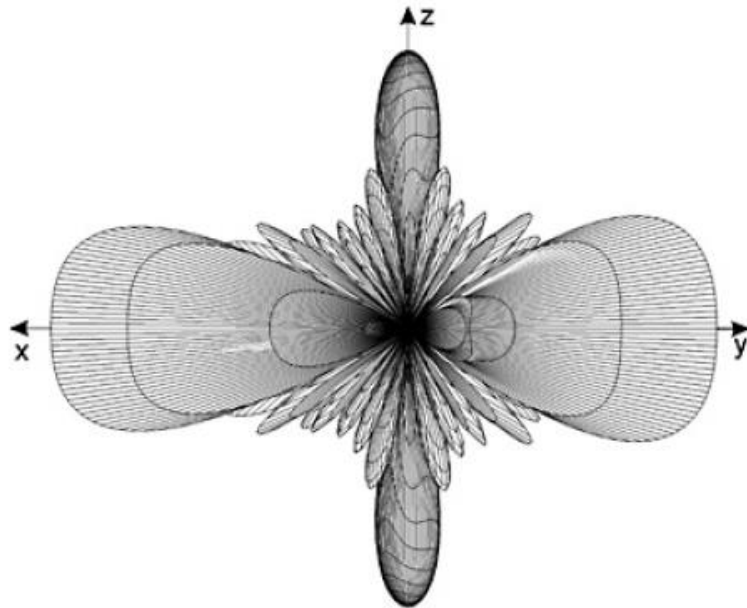

Figure 7: Radiation pattern of an 8\*6 rectangular antenna array [8]

## 2.6 Phased Arrays

A group of individual radiators combined together in a straight line or two dimensional configurations. The excitation current amplitude and phase can be controlled [9]. In other words each element in the array can be fed with either different amplitude of current or different phase of the excitation current or both the phase and amplitude of the excitation current can be changed or controlled. The main purpose and application of the phased arrays is the controlling of beam in the space. Changing the position of the main beam in the space and changing the shape of the beam (from a narrow beam to wide beam) can be obtained using phased arrays. Phase of the excitation current that each element of the array is receiving is the most critical factor, which decides the position of the main beam in the space. The phenomenon is called as Beam Scanning, where mechanical movement of the antenna array is avoided to change the position of the main beam of the antenna.

### 2.6.1 Radiation Pattern of Linear Phased Arrays

Consider an N isotropic element array, separated from each other with distance d. The distance d is same between all adjacent elements. From a direction which makes an angle  $\theta$  with the normal of the array, a plane wave is applied. The current in the  $n$ th element of the array can be expressed as;

$$i'_n = Ae^{jn\beta d \sin\theta} \quad (2.28)$$

Where A is the amplitude associated with the excitation current and  $\beta$  here is the wave number, which is equal to  $\frac{2\pi}{\lambda}$ .

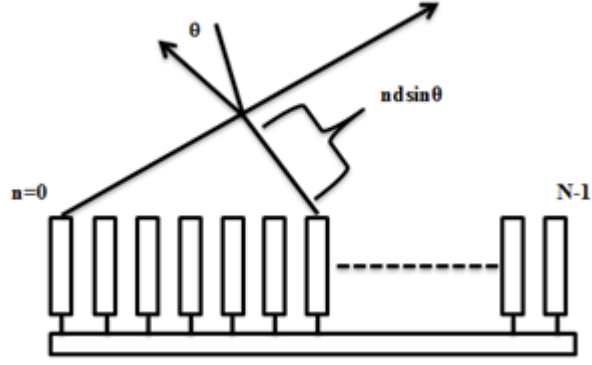

Figure 8: Basic linear phased array

It can be observed from Figure 8 that the current in  $n^{th}$  element in the array leads by a phase difference of  $\Delta\psi$  from the  $(n+1)^{th}$  element. This phase difference is the factor which introduces a time delay in the arrival of wave front at the point of observation or focal point. In virtual, we can realise the situation by considering a phase control behind each element of the array. The expression for the  $n$ th element becomes,

$$\frac{i_n''}{i_n'} = a_n e^{j\psi_n} \quad (2.29)$$

Here,  $a_n$  is the current gain and  $\psi_n$  represents the phase shift of the control element.

As we sum up all the elements in the network we get,

$$E_a = \sum_{n=0}^{N-1} a_n e^{j(\psi_n + n\beta d \sin\theta)} \quad (2.30)$$

This is the expression for the array factor, in which  $a_n$ 's and  $\psi_n$ 's are the controlling elements.  $a_n$  controls the array amplitude taper while that of  $\psi_n$  is known as phase taper. To produce a maximum radiation in a specific direction let say  $\theta_0$ , the received signal from all elements is combined in phase, and hence  $\psi_n$  is in the form of;



$$\Psi_n = -n\beta d \sin \theta_0 \quad (2.31)$$

The above expression gives the required phase taper for a linear phased array. When the phases of the control elements are set to that of the phase taper, the radiated power is supposed to add up in that specific direction, producing a maximum radiation.

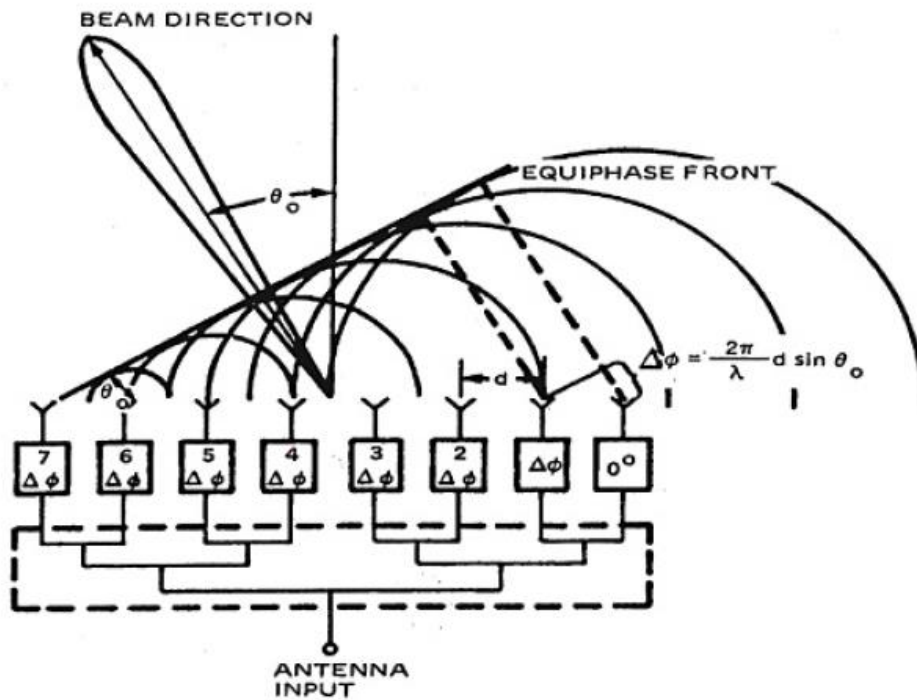

Figure 9: Beam steering concept with phase shifters [8]

### 2.6.2 Near Field Focused Arrays

Near field focused arrays are demanded by modern day technology. As the need of smart and compact devices arose among the people, the researchers started to think about providing more versatility to the existing arrays. Initial attempts were made to focus the field radiated by antennas, by putting focusing lenses in front of arrays. The disadvantages with these methods are, the current day devices do not support extra structure to be added, to avoid bulky structures.

The idea of controlling the phase shift of each element in the array was proposed to get the field focused at certain point in the space. The phase shift is actually with respect to a reference point selected. In order to get the exact element's phase shift, that will work for focusing the field, the transmission line lengths are varied with respect to reference point. Upon experimentations and intensive study [10], [11], an expression has been developed, which calculates the phase shift at each element of the array in order to focus the field produced by array at its focal point. For a rectangular array, where the elements lay on a plane and the focal point is at the distance in the space, the expression for the phase distribution is given by equation (2.32);

$$\phi_i = k \left[ \sqrt{(x_k - x_f)^2 + (y_k - y_f)^2 + (z_k - z_f)^2} - (x_f + y_f + z_f) \right] \quad (2.32)$$

where  $x_k, y_k, z_k$  are the coordinates of  $i$ th element of array respectively. Where  $x_f, y_f, z_f$  are the coordinates of the focal point. Upon following the above phase distribution, the maximum field of all the elements will be combined to sum up and focused at a point in the near field region of the antenna.

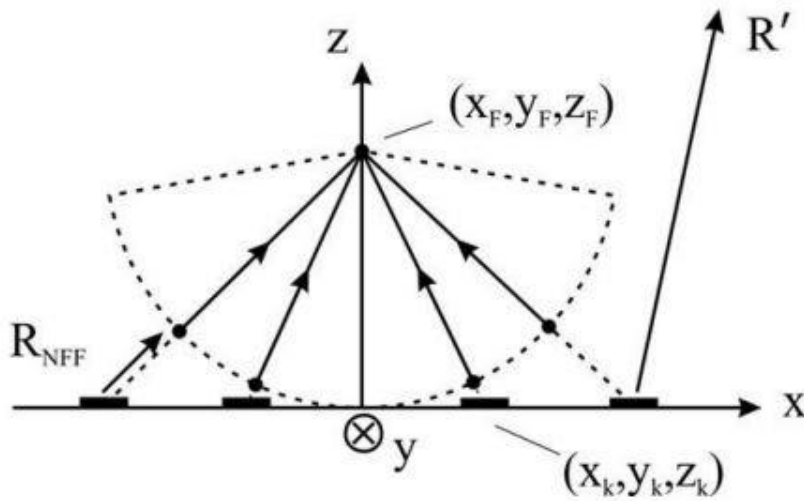

Figure 10: Near field focused planar array [11]

## Chapter 3

### MICROSTRIP PATCH ANTENNA

#### 3.1 Microstrip Patch Antenna

Microstrip patch antennas are categorized as a planar type of antennas. Planar antennas refer to the antennas which lie in one plane. They are called as Printed Antennas, due to the printed sheet of conductor, used in its radiating element. These kinds of antennas were first introduced in the era of 1950s [12] but it did not get popular among the researcher and after a wait of almost 20 years researchers realised the use and advantage of Printed Circuit Board (PCB) technology. In 1970s microstrip antennas became popular and revolutionized the printed circuit board technology. At the age when people realised the use of compact devices, less weight and less bulky devices, the researchers were attracted towards this technology. Microstrip antennas has several advantages over the conventional antennas such as low profile, less weight, low power handling capability, planar configuration and to be used in rigid surfaces.

Their versatility to be configured with Microwave Monolithic Integrated Circuits (MMIC) expands its range of applications. MMIC refer to the integrated circuits which work with Microwave Frequency Range. Applications of microstrip patch antennas are enormous and modern day. They are widely used in medical applications, military and civilian applications, e.g. Global Positioning System

(GPS), radio, Radio Frequency Identification (RFID) Systems, satellite, radar and missile technology.

### 3.2 Geometries of Basic Microstrip Patch Antennas

At starting stages of printed circuit board technology, microstrips were only used as circuit element or as transmission lines but the need of microstrip as a radiation element were felt soon and soon it became one of the popular technologies of that time. In 1950s, it was Deschamps [12], who proposed the idea of microstrip antennas but he couldn't get any attention. Later on in 1970s, people begin to understand the significance of microstrip patch antennas.

The basic structure of microstrip patch antenna comprises of four parts;

- Conducting Patch Metallization
- Dielectric Substrate
- Conducting Ground Plane
- Feed Structures

The basic microstrip patch antenna is given in Figure 11;

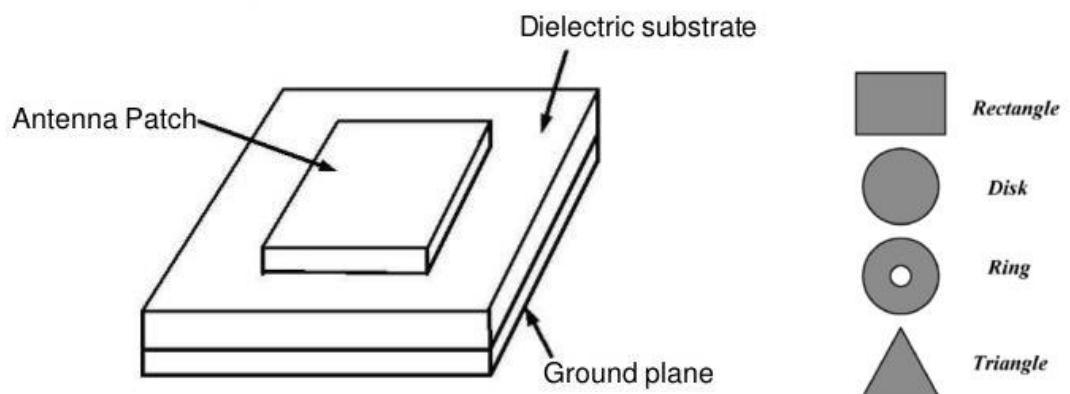

Figure 11: Basic microstrip patch antenna

The basic structure consist of an upper metal sheet, known as patch and lower metallic ground plane separated by a thin dielectric substrate between them. Patch is also called as radiating patch because this is the part of structure which radiates. The patch metallization can be of copper or gold, but usually gold is avoided due to the reason that it is an expensive metal. The patch shape theoretically can be any arbitrary shape but in practical cases, it can have any regular geometry. The most common patch shapes are rectangular, square, triangular, circular etc., as shown in Figure 11.

The substrate is basically a non-conducting medium used as a dielectric between the ground and patch. The substrate is usually a thin sheet, having certain height. The height of substrate can be termed as thickness of substrate. As like every dielectric medium, the substrate has its relative permittivity  $\epsilon_r$ . Microstrip Patch antenna in practical cases uses dielectric of permittivity values  $1 \leq \epsilon_r \leq 20$ . The most widely used dielectric substrates are FR-4, RogersRT, Duroid and Silicon. The relative permittivity of the substrate is the most crucial parameter, which decides the size of the antenna, which in turns decides the frequency of the operation of the antenna. The lower the relative permittivity of the substrate, the larger is the size of antenna and vice versa. Similarly, the thickness of the substrate plays a key role in bandwidth of the antenna. The thicker the substrate is, the larger the bandwidths we get, but keeping in mind, by increasing the thickness of substrate, surface waves are introduced, making the structure inefficient. The ground plane is a conducting metal structure having same dimensions as the substrate, is acting as ground to the

radiating patch element. The structure of microstrip patch antenna is incomplete without the feeding structure, discussed as under.

### **3.3 Feeding Techniques**

Feeding techniques or feeding methods refer to the way of applying excitation to the antenna structure. For an antenna to radiate there should be an excitation signal. That excitation signal to a microstrip patch antenna can be applied through four techniques [12], listed as below.

- Co-axial Probe Feed
- Microstrip Line Feed
- Aperture Coupled Feed
- Proximity Feed

#### **3.3.1 Co-axial Feed**

In this type of feeding, the structure is excited through a probe or co-axial cable from beneath as shown in Figure 12. Usually a co-axial cable of known impedance is taken to feed the antenna. The inner conductor of the co-axial cable is connected to the patch of the antenna while the outer conductor (shield) is connected to the ground metal. Both the inner and outer conductors are isolated from each other by a dielectric material between them. The relative permittivity of the co-axial cable dielectric material and the radius of inner, outer conductor decide the impedance of the co-axial cable.

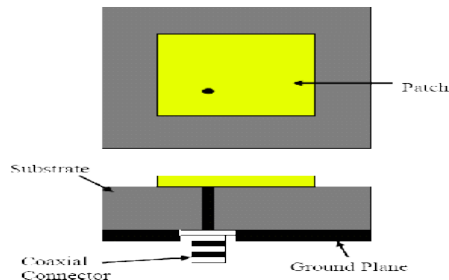

Figure 12: Co-axially fed rectangular MPA [8]

### 3.3.2 Microstrip Line Feed

In microstrip line feeding technique a conducting strip of a certain width is directly connected to the edge of the patch as shown in Figure 13. The width of the feed represents certain impedance, at which the antenna has to be matched. The width of feed line is smaller as compared to the patch size. The advantage of this type of feeding is that the strip lies on the same plane as the patch is, preserving the planar structure of the antenna.

Most of the time an inset cut in the patch is introduced for the purpose of impedance matching, known as inset feed. Microstrip line is the easiest of all feeding techniques in terms of fabrication. As the width of the microstrip line is very narrow as compared to the substrate, so it is normally exposed to the surface waves hence decreasing the bandwidth of the antenna and cross polarization is introduced.

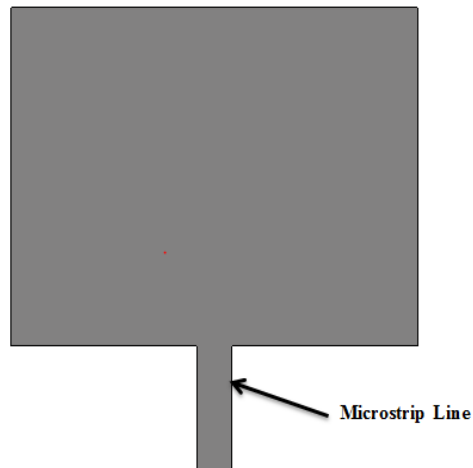

Figure 13: Microstrip line feed

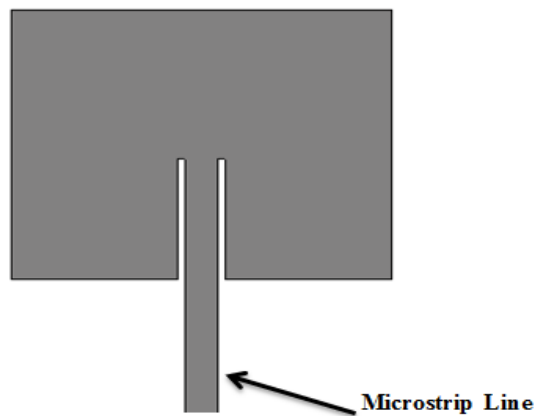

Figure 14: Inset feed

### 3.3.3 Aperture Coupling Feed

This type of feeding technique is also called non-contacting feed. In Aperture Coupling technique, the feeding stripline is not electrically connected with the patch. The stripline and patch is electrically isolated by the ground plane. Usually an aperture or slot is made within the substrate to provide magnetic coupling of the stripline with the patch. The slot or aperture is usually at the centre of the patch, resulting in very low cross polarization. Two dielectric substrates are used in this kind of feeding as shown in Figure 15.



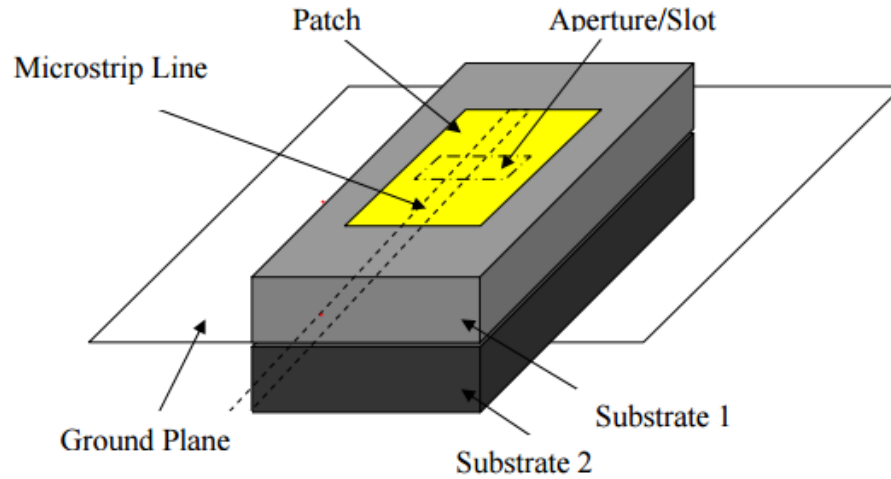

Figure 15: Aperture coupling feed [7]

The disadvantage of this kind of feeding is its fabrication complexity, which makes it a little unpopular as compared to the co-axial and microstrip feed.

### 3.3.4 Proximity Feed

Proximity feeding also is a non-contacting feeding method. As shown in Figure 16, the feed line is sandwiched between two dielectric substrates. The feed line is not connected directly to the patch. It is magnetically coupling to the patch metal. As using two substrates increases the thickness of the substrate part, hence these kind of feeding methods improve the bandwidth of the structure. Similar to aperture coupling feed, proximity feed is very difficult to fabricate.

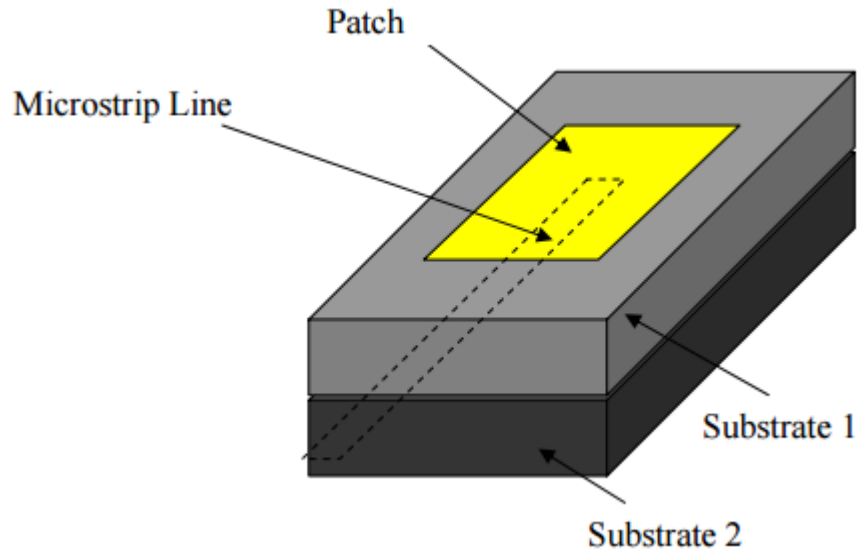

Figure 16: Proximity coupled feed [7]

### 3.4 Analysis of Microstrip Patch Antenna

Microstrip patch antennas can be analysed using different models of analysis. The most popular ones are given as;

- Transmission Line Model
- Cavity Model
- Fullwave Model ( Method of Moment)

Transmission Line model is the most easy and practical model of analysis. Cavity model is more efficient and accurate but it is complex. Fullwave model is the most accurate as compared to the other models discussed. The disadvantage of this kind of model is that it doesn't give a good physical realization of the structure as compared to the transmission line and cavity model. As transmission line model gives a very good physical realization, we have chosen transmission line model to be followed.

### 3.4.1 Transmission Line Model

Transmission line models provide an insight of some empirical formulas that would be used to calculate the geometrical parameters of the microstrip patch antenna [13]. To understand transmission line model, we have to create a scenario, in which a microstrip patch antenna is treated as two slots. These two slots have certain width denoted as “W” and a height or thickness “h”, having a transmission line of length “L” in between them.

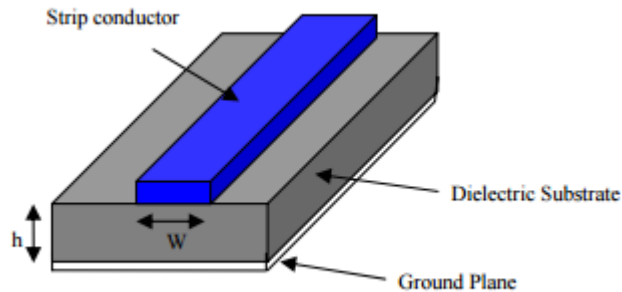

Figure 17: Microstrip line [8]

The electric field lines lay both in the air and within the substrate. Most of the lines lies in the substrate and a less portion of lines are in the air as well. It is a known fact that the phase velocities varies from medium to medium. The phase velocity within a substrate having a particular relative permittivity is not same as in the air. Due to the stated reason, this kind of transmission line do not support pure transverse electromagnetic mode (TEM). Transverse EM mode is here replaced by another dominant mode known as Quasi-TEM mode. Hence, to find the fringing field, an effective dielectric permittivity  $\epsilon_{\text{reff}}$  has to be found. As the dimension of the substrate is larger as compared to the patch or transmission line, so the effective dielectric permittivity value has to be less than that of relative permittivity. It is usually slightly less than relative permittivity.

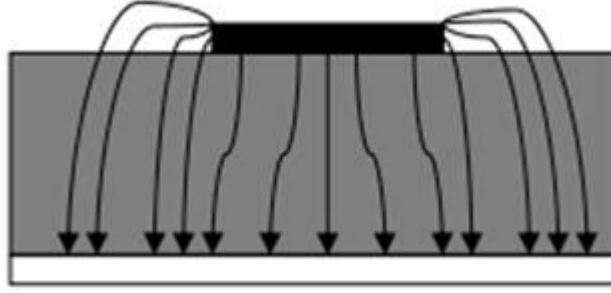

Figure 18: Electric field lines [8]

Figure 14 shows the electric field lines distribution. It can be clearly observed that the field lies in both the substrate and in the air as well. The effective dielectric constant can be calculated as [7];

$$\epsilon_{r_{eff}} = \frac{\epsilon_r + 1}{2} + \frac{\epsilon_r - 1}{2} \left[ 1 + 12 \frac{h}{W} \right]^{-\frac{1}{2}} \quad (3.1)$$

where,  $\epsilon_r$  is the relative dielectric permittivity,  $h$  is the height or thickness of the substrate and  $W$  is the width of the patch.

### 3.4.2 Geometrical Parameters of MPA

Transmission line model can be used to find out the geometrical parameters of the microstrip patch antenna. Let us suppose, a rectangular microstrip patch antenna having patch length  $L$  and patch width as  $W$ . The patch metallization is lying on a substrate of relative permittivity  $\epsilon_r$ , having certain thickness  $h$ . The length of the antenna is taken along x-axis, the width along y-axis and the thickness of the structure is along z-axis.

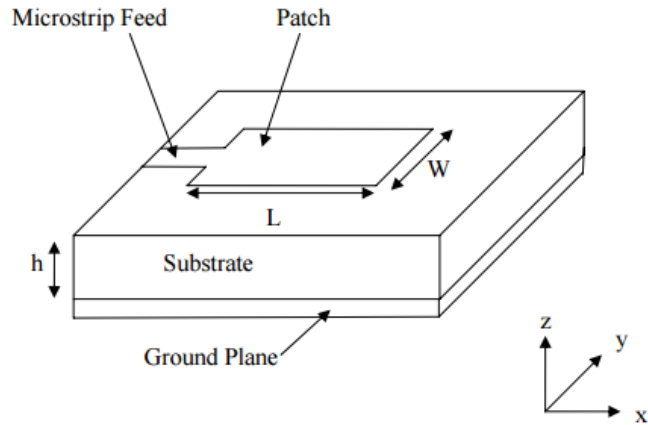

Figure 19: Microstrip patch antenna [8]

For the operation in  $TM_{10}$  mode, the length of Patch  $L$ , is supposed to be fractionally less than half wavelength. The wavelength here is the wavelength within the medium or substrate. Wavelength within the dielectric medium can be stated as;

$$\lambda_g = \frac{c}{f\sqrt{\epsilon_{reff}}} \quad (3.2)$$

Where,  $c$  is the speed of light and  $f$  is the operating frequency of the antenna. In Figure 15, it can be seen that the microstrip patch antenna is shown as two open circuit slots, separated by a transmission line.

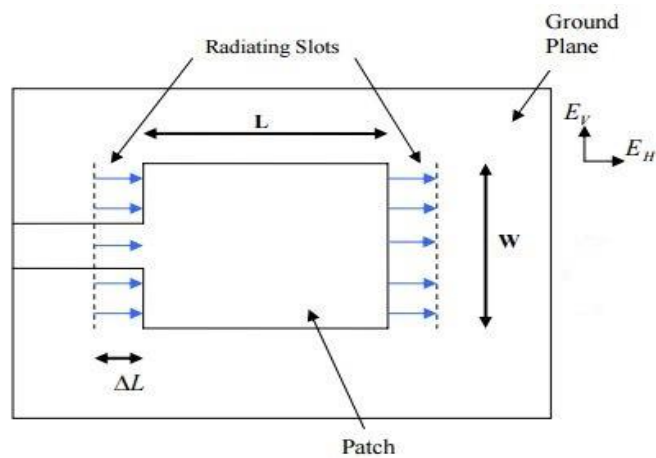

Figure 20: Top view of the patch antenna [8]

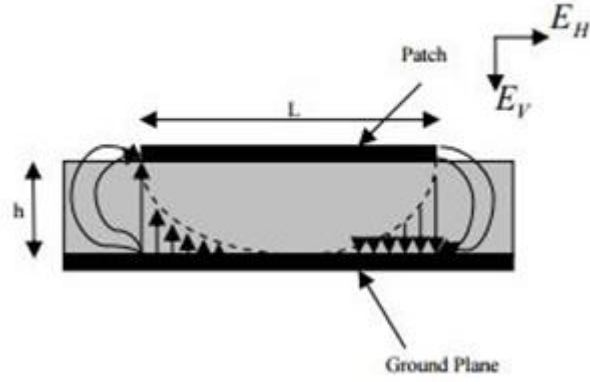

Figure 21: Side view of the patch antenna [8]

From Figure 21 it can be observed that the normal components at both the edges are out of phase and opposite in direction, which cancels the effect of each other in the direction of the broad side. As the tangential components of the field are having same phase, hence they combine to form a maximum field in the direction perpendicular to the axis of the antenna. Here, it can be noticed that the fringing field can be referred as radiating slots, making it look like that the physical length of the patch of microstrip has been increased electrically. The increase in length can be denoted as  $\Delta L$ . Where  $\Delta L$  can be empirically calculated by Hammerstad [7] as ;

$$\Delta L = 0.412h \left[ \frac{(\epsilon_{reff} + 0.3) \left( \frac{W}{h} + 0.264 \right)}{(\epsilon_{reff} - 0.258) \left( \frac{W}{h} + 0.8 \right)} \right] \quad (3.2)$$

The length of the antenna is equal to;

$$L = L_{eff} - 2\Delta L \quad (3.3)$$

For a given frequency, the equation for the effective length can be modified as;

$$L_{eff} = \frac{c}{2f_0 \sqrt{\epsilon_{reff}}} \quad (3.4)$$

Bahl and Bhartia [13] proposed an expression for the calculation of the width of patch W.

$$W = \frac{c}{2f_0 \sqrt{\frac{\epsilon_r + 1}{2}}} \quad (3.5)$$

Hence, using a transmission line model, the geometrical parameters of microstrip patch antenna can be calculated.

## Chapter 4

### MICROSTRIP PATCH ANTENNA ARRAY

#### 4.1 Microstrip Patch Antenna Array

A single element microstrip patch antenna is a structure usually designed for low power applications. It also has the limitation of low gain, narrow bandwidth and loss directive. For applications where the requirements are high gain and high directivity in compact and conformal devices, microstrip patch antenna array is used because of the ease of fabrication and the configurability with Microwave Monolithic Integrated Circuits (MMIC) technology. Cost is one of the key factors in choosing microstrip patch antenna as the array element, because it is cheap and easily available. Microstrip patch antenna arrays are highly popular for their significance in beam scanning and radiation field focusing.

#### 4.2 Array Arrangement

Similar to conventional antenna array, microstrip patch antenna elements can be interconnected in several ways to get an array. The most popular and widely used are given as [8];

- Linear Microstrip Patch Antenna Array
- Planar Microstrip Patch Antenna Array

There are several other arrangements as well but the scope of my thesis is restricted to the stated type of arrangements. Linear MPA arrays are such type of array in which all the elements are arranged along a straight line, while that of Planar MPA



array, the arrangement is in a certain plane, making a rectangular or square type of shape.

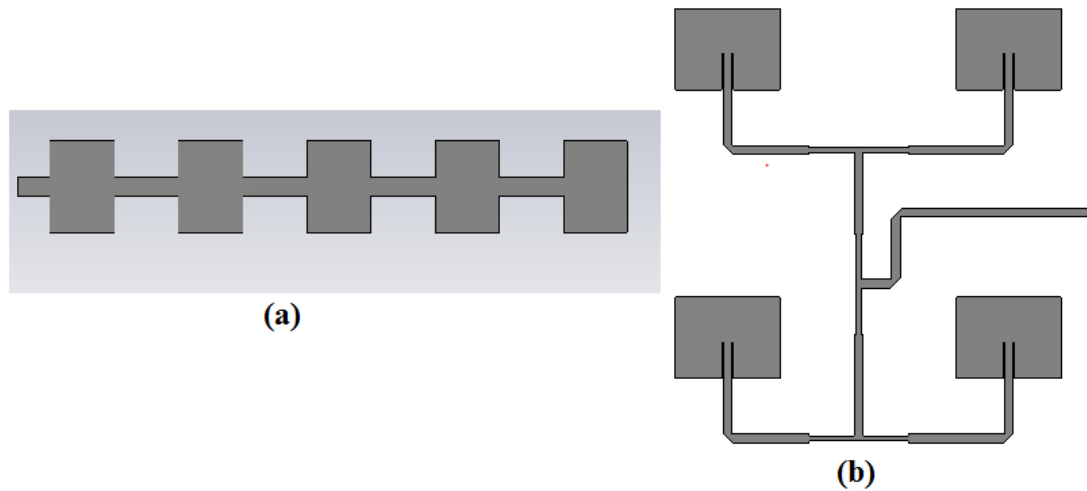

Figure 22: (a) Linear MPA array and (b) Planar MPA array

### 4.3 Feeding Networks

Feed network in microstrip patch antenna arrays play a very vital role. It is the feed network through which excitation signal is distributed to each element of the array. There are two widely used feed networks in microstrip patch antenna arrays, listed as below;

- Series Feed Network
- Corporate (Parallel) Feed Network

Linear MPA arrays can be fed both with series feed and corporate feed networks but planar MPA arrays are mostly fed with corporate feeding network. Series feed network is a simple feed network while corporate feeding network uses microstrip T-junctions and bends in order to distribute the signal through all elements of the array.

### 4.3.1 Series Feed Network

Series feed network is one of the earliest and first used feed networks for microstrip patch antenna array [14]. In this kind of arrangement, the microstrip patch elements are connected through a series transmission line (Microstrip). The arrangement of the feed network and elements is just like a cascaded system. The series feed network can be illustrated using Figure 23 below.

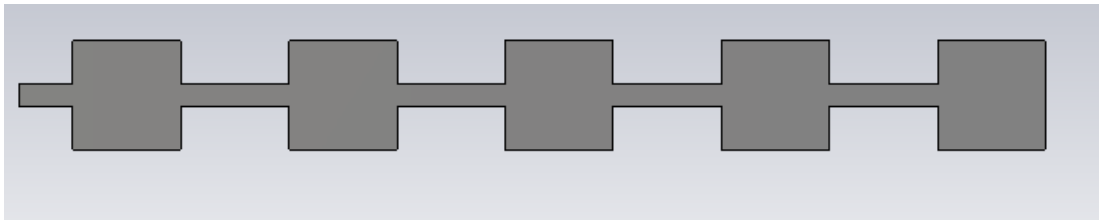

Figure 23: Series fed MPA linear array

It can be clearly observed from the Figure 23 that two of the adjacent linear array elements are separated from each other by a planar transmission line. The arrangement is repeated for every element, making a cascaded arrangement of patch elements. The array is excited from the left side. In this case the array structure can be realised as a waveguide but the difference here is that the impedance of the microstrip line can be changed to produce an amplitude taper.

These arrays are widely used for their advantages such as simple structure, low cost, compact structure and very low transmission line losses. However, these kinds of feed structures suffer from narrow bandwidth problems.

### 4.3.2 Parallel Feed Networks

Unlike series feed networks, the parallel feed networks [14] are such networks in which each element of the array is fed parallel, irrespective of the adjacent element. These types of networks are also called as corporate feed networks. These kind of

feed networks use power splitter/dividers/combiners for the distribution of power to each element of the array. Usually a T-junction is used for this purpose. A T-junction either splits the power coming from a single transmission line into two parts or combines a signal from two lines into a single transmission line. For instance a 3 port power splitter splits the power coming from port 1 into port 2 and 3. The output power depends upon the type of splitter used. The output can be equally split into two or it can be unequal splitting as well. Figure 24 explains the geometry of corporate fed MPA array.

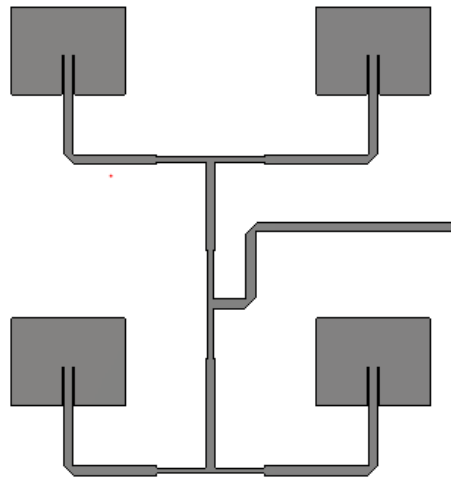

Figure 24: Parallel (Corporate) fed MPA array

Apart from feed arrangement shown in Figure 24, there are several other arrangements of parallel or corporate feed as well, that can be used according to application. Basically the network is composed of three parts;

- Microstrip Line
- Microstrip T-Junction Power Divider
- Microstrip Bends

Microstrip line is a trace of metal, whose width and lengths corresponds to specific impedance and are used to transmit power in planar structure such as microstrip structures. The impedance of the line is calculated based on empirical formulas, which inputs the width of line, relative permittivity of the substrate, thickness of the substrate, frequency of the operation and results in a value of impedance  $Z_0$ .

$$Z_0 = \frac{\eta_0}{2\pi\sqrt{2}\sqrt{\epsilon_r+1}} \times \ln \left[ 1 + 4 \left( \frac{H}{W_{eff}} \right) \times (X_1 + X_2) \right] \quad (4.1)$$

Where,

$$W_{eff} = W + \left( \frac{T}{\pi} \right) \times \ln \left\{ \frac{4e}{\sqrt{\left( \frac{T}{H} \right)^2 + \left( \frac{T}{\omega\pi + 1.1t\pi} \right)^2}} \right\} \times \frac{\epsilon_r + 1}{2 \times \epsilon_r} \quad (4.2)$$

$$X_1 = 4 \left( \frac{14\epsilon_r + 8}{11\epsilon_r} \right) \left( \frac{H}{W_{eff}} \right) \quad (4.3)$$

$$X_2 = \sqrt{16 \times \left( \frac{H}{W_{eff}} \right) \left( \frac{14\epsilon_r + 8}{11\epsilon_r} \right)^2 + \left( \frac{\epsilon_r + 1}{2\epsilon_r} \right) \times \pi^2} \quad (4.4)$$

Figure 25, shows the basic parameters of microstrip calculation.

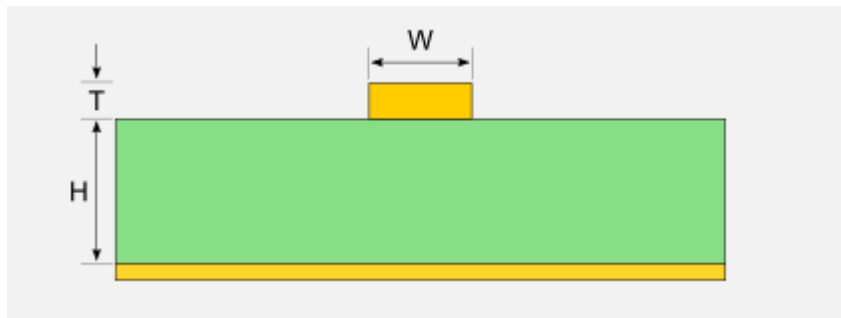

Figure 25: Microstrip line

Where  $W$  is the width of the microstrip line,  $T$  is the thickness of patch element and  $H$  is the thickness of substrate.

### 4.3.3 Microstrip T-Junction, Power Divider

The T-Junction power divider/splitter is a three port network similar to Wilkinson 3 port power divider but it doesn't have any isolation between the output ports [15]. In Wilkinson power divider, the output ports 2 and 3 are having an isolation from each other. The resistance applied between port 2 and 3 is used to stop the power to transmit in the backward direction towards source. Usually the reflection effects the VSWR, but in case of T-Junction, it is till acceptable because of the quarter wavelength length between the two output ports, which somehow cancel the reflection at the input.

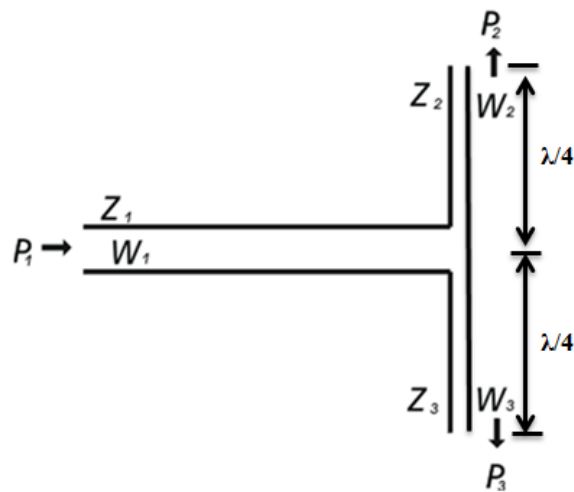

Figure 26: T-Junction power divider

$P_1$  is the input port. The power at  $P_1$  is split into two outputs  $P_2$  and  $P_3$ . T-junction strongly depends upon the quarter wavelength of the output port, for the smooth transition of power from high impedance to low impedance microstrip lines.

$Z_1$  is the impedance of the common port, while  $Z_2$  and  $Z_3$  are the impedances of split ports. Mathematically  $Z_2$  and  $Z_3$  are given as below;

$$Z_2 = Z_3 = \sqrt{2}[Z_1] \quad (4.4)$$

#### **4.3.4 Microstrip Bends**

In most of the feed networks unlike series feed networks, the transmission lines are not always in a straight line, they are supposed to bend up to certain degrees. For instance, if a horizontal transmission line has to be bended to a vertical transmission line i.e.  $90^\circ$ . What happens when the transmission line is bended abruptly up to  $90^\circ$ ? Most of the power from the input is reflected back at the discontinuity towards the source, which reduces the performance of the system.

A  $90^\circ$  bend in transmission line cause the change in capacitance of the line, which in turns change the impedance of the line. The change in impedance causes a mismatch. To encounter such problems, microstrip mitred bends are introduced. The purpose of the mitred bend is to chop that little amount of capacitance to bring back the impedance of the line to the matching impedance. A mitred bend is shown below in Figure 27.

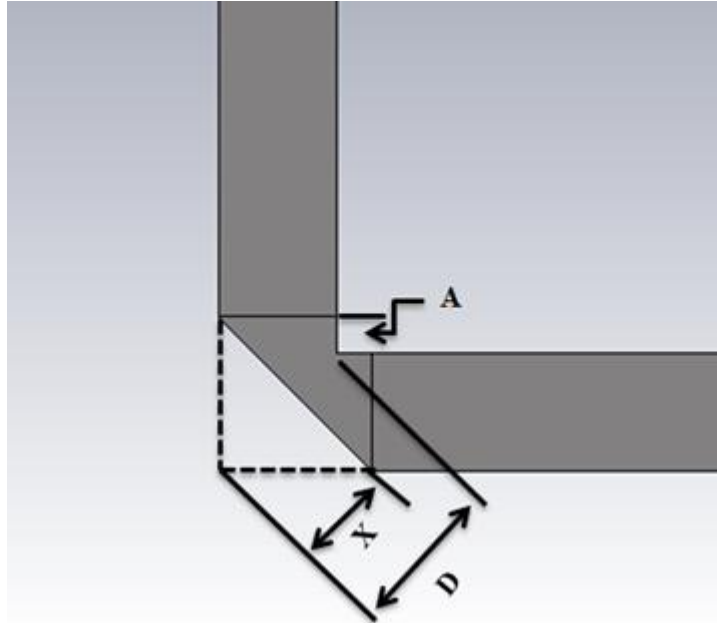

Figure 27: Microstrip mitred bend

The values of X, D and A are calculated back in 1970 by [16]-[17]. According to this research, if the bend is designed using the dimensioned specified in Figure 27 above, the impedance would be transformed without any change from 0 degree to 90 degrees. The mathematical calculations carried out are given in the equations below;

$$D = W \times \sqrt{2} \quad (4.6)$$

$$X = D \times \left( 0.52 + 0.65e^{\left(-1.35 \times \frac{W}{h}\right)} \right) \quad (4.7)$$

$$A = \left( X - \frac{D}{2} \right) \times (\sqrt{2}) \quad (4.8)$$

Where W is the width of the transmission line and h is the thickness of the substrate.

## Chapter 5

### DESIGNS, SIMULATION RESULTS AND DISCUSSION

#### 5.1 Design Structure

The design structure has been carried out in three steps. The first design is a single element Rectangular microstrip patch antenna. The second design is a  $4 \times 4$  rectangular MPA array, having corporate feed network. This design is the near field focused array. The third design is achieved by modifying the feed network of the second design. Design three results in a structure, which is able to move the focus spot with variation in frequency. All the designs are carried out using simulator full wave simulation software. This chapter includes the detailed study of all the three designs.

#### 5.2 Single Element Microstrip Patch Antenna

This design is a conventional Rectangular microstrip patch antenna which is used as array elements in  $4 \times 4$  array. The dimension of the inset fed antenna patch is  $36 \times 28 \text{ mm}$ , using dielectric substrate *FR-4* with relative permittivity 4.3. The thickness of the dielectric substrate is 1.6 mm. Figure 25 shows the details of the design.



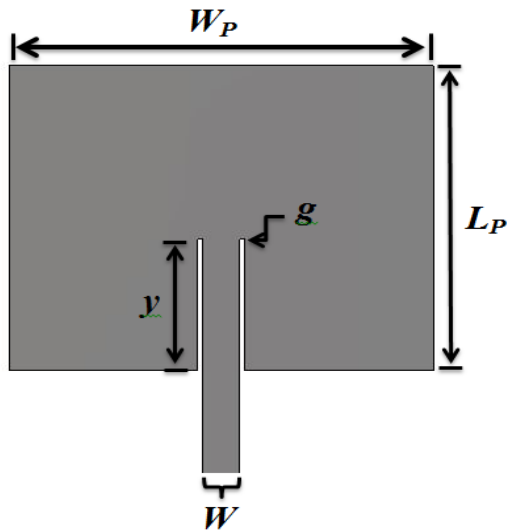

Figure 28: Rectangular microstrip patch antenna

Where,  $W_p$  is the width of the radiating patch and  $L_p$  is the length of the patch. The inset feed gap “ $g$ ” is  $0.445\text{ mm}$  while the length “ $y = 12.5\text{ mm}$ ”. The width of the stripline can be calculated using CST Microwave Studio impedance calculator. For a  $50\Omega$  microstrip line, the value of  $W$  using  $FR-4$  substrate  $1.6\text{ mm}$  thick, turns out to be  $3.11\text{ mm}$ .

### 5.2.1 Single Element RMPA Results

The design upon simulation resulted in an antenna resonating at  $2.4\text{ GHz}$ . The return loss of antenna is given as below;

### 5.2.2 Return Loss

The return loss result shows that the antenna structure resonated at  $2.4\text{ GHz}$  with the return loss of  $-30\text{ dB}$ . The return value corresponds to a very good match and low reflections. The  $-10\text{ dB}$  bandwidth of the structure is found to be about  $50\text{ MHz}$ .

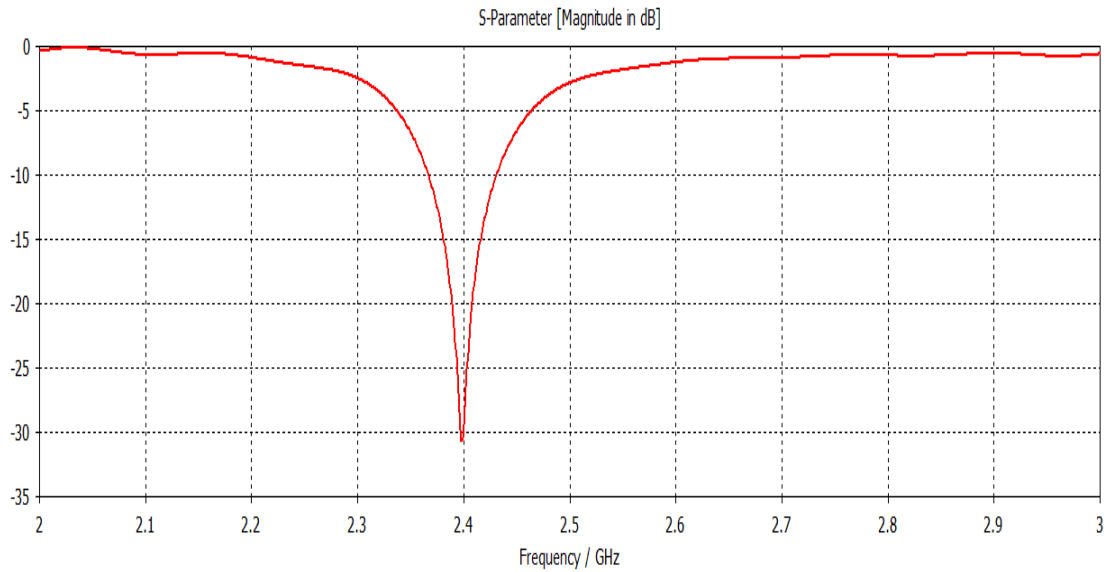

Figure 29: Return loss of rectangular microstrip patch antenna

### 5.2.3 Far-Field Radiation Pattern

The 3-D Far-Field radiation pattern of antenna is shown in Figure 29. The directivity of the antenna is  $6.1\text{dBi}$  and the gain is about  $4.08\text{dB}$ .

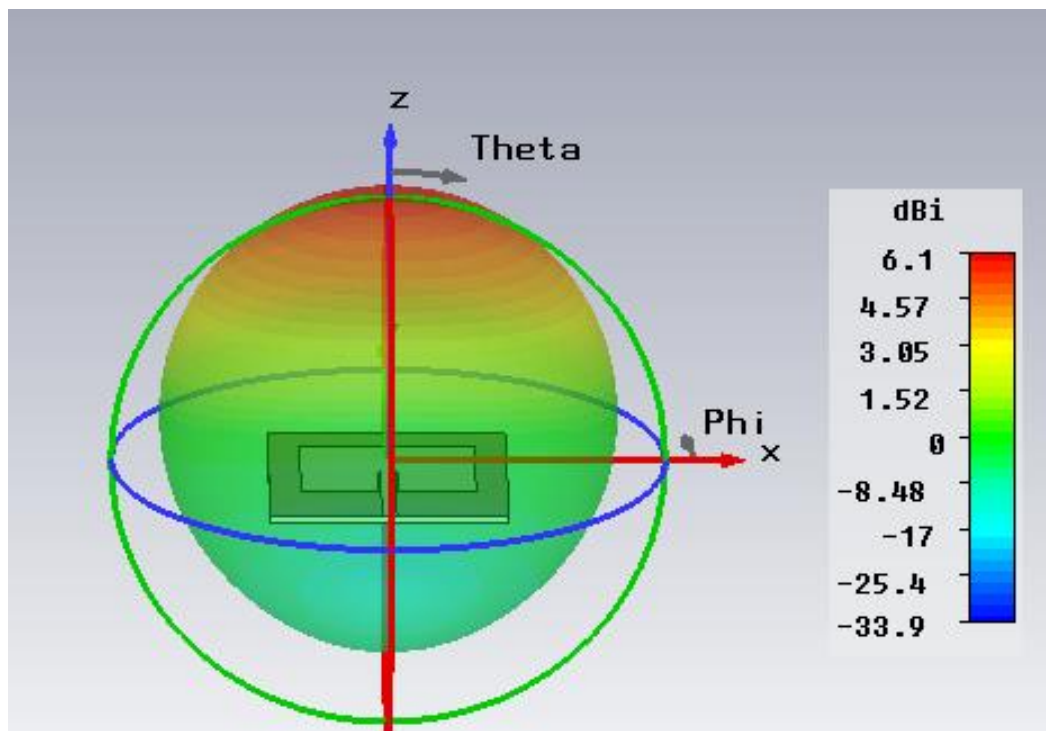

Figure 30: 3-D Far-field plot

Table below shows summary of the antenna parameters.

Table 1: Summary of the simulation results

Parameter	Value
Frequency	2.4GHz
Return Loss	-30dB
Directivity	6.1dB
Gain	4.08dB
Bandwidth	66MHz
VSWR	1.06

### 5.3 4\*4 Rectangular Microstrip Patch Antenna Array

A 4×4 rectangular microstrip patch antenna array fed with a corporate feed network is presented. The dimensions of single element is same as in the single element antenna except the gap  $g$ , which is varied in order to get maximum matching between the transmission line and antenna structure. Figure 31 below illustrates the 4×4 microstrip patch antenna array.

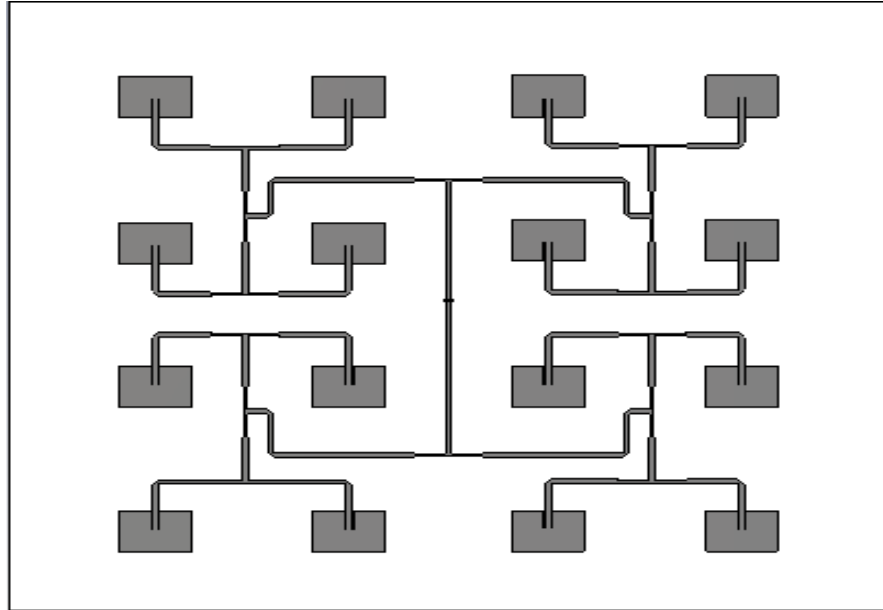

Figure 31: Rectangular microstrip patch antenna array

The array design basically comprise of 16 rectangular microstrip patch antennas. The corporate feed network is used for transmission and collection of power. The feed network is basically composed of three parts.

- Microstrip Lines
- T-Junctions
- Mitred Bends

### 5.3.1 Microstrip Lines

Microstrip lines of certain width  $W$  refer to specific impedance. In the feed network, two different impedance transmission lines are used. All the elements of the array are supposed to be matched at standard  $50\Omega$  impedance and hence the width of  $50\Omega$  is chosen as  $W_1 = 3.11mm$ . The impedance of the line is calculated using equation (4.1). Another  $71\Omega$  microstrip line is used here as the output ports of the T-Junction. The width of this line is  $W_2 = 1.6mm$ .

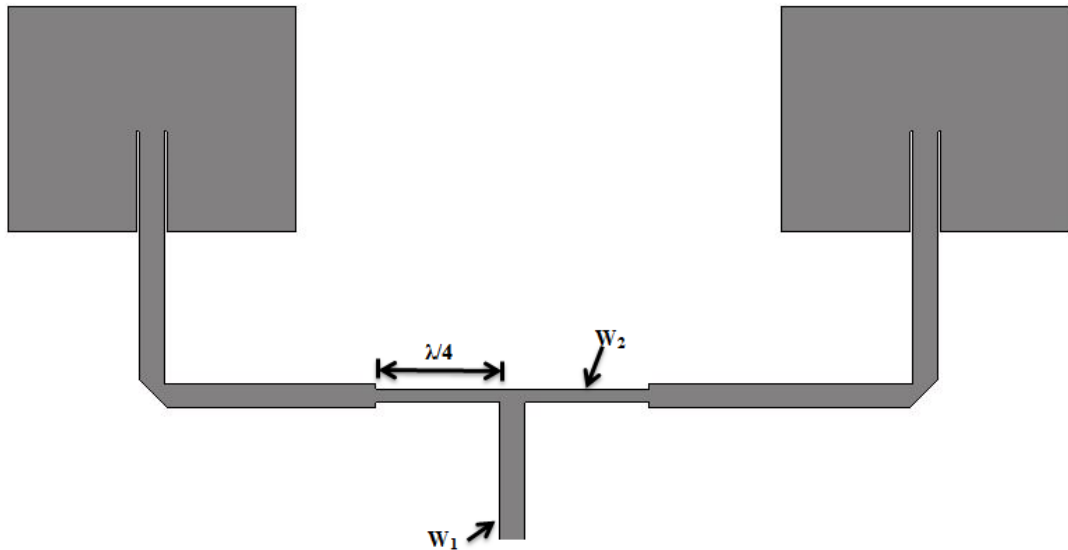

Figure 32: 2-Element sub array

It can be seen from a two element sub array from  $4 \times 4$  array, that two microstrip lines are used i.e.  $50\Omega$  and  $71\Omega$ .

### 5.3.2 T-Junction

The T-Junction used here is splitting the input power from the  $50\Omega$  line into two  $71\Omega$  lines. As discussed earlier in chapter 4, the T-junction output ports highly depends upon the quarter wavelengths, hence the length of two  $71\Omega$  lines are taken as  $17.1mm$ , as shown in Figure 32.

### 5.3.3 Mitred Bend

In order to avoid transmission lines physical contact from each other and to make a practically applicable feed network, most of the times the bending of microstrip line is required. Mitred bend are used to bend the microstrip line without any power loss, as discussed earlier. The dimensions of the bend can be calculated using equations (4.5), (4.6) and (4.7) in chapter 4. The designed array has mitred bend having the values of  $A, X, D$  as  $0.417mm$ ,  $2.4944mm$  and  $4.3981mm$  respectively.

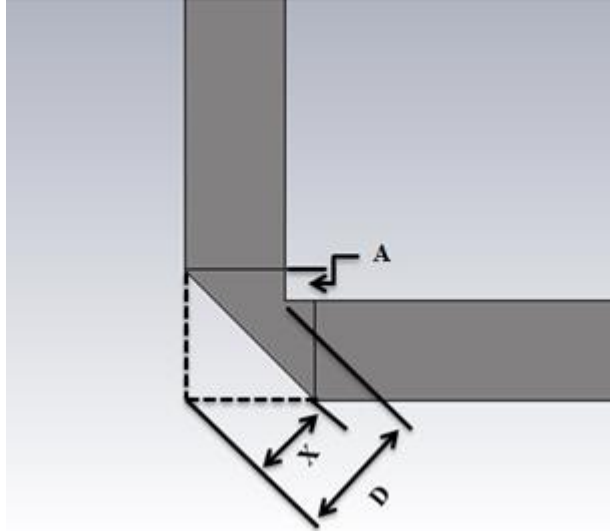

Figure 33: Mitred bend

### 5.3.4 Array Elements Phase Distribution

The phase distribution to each element of the array is the factor which will decide the focusing characteristics of the array. Each element will be having a different phase shift with respect to a reference point. The phase shift is provided to each element by microstrip lines having different lengths from the reference point. In practical case a time delay has been introduced from element to element, which is going to decide which element has to radiate first and so on. The modified form of phase distribution for array design is given by equation (5.1);

$$\phi_i = k \left[ \sqrt{x_i^2 + y_i^2 + z_f^2} - z_f \right] \quad (5.1)$$

Where  $x_i$  and  $y_i$  are the coordinates of the  $i$ th element of the array.  $z_f$  is the focal point. Focal point of the array is  $z_f = 800 \text{ mm}$ .

The phase difference for all 16 elements of the array is calculated and tabulated in Table 2.

Table 2: Phase distribution of 4\*4 array

Array Elements	1	2	3	4
1	79.6°	44.56°	44.56°	79.6°
2	44.56°	8.98°	8.98°	44.56°
3	135.44°	135.44°	131.02°	135.44°
4	100.4°	135.44°	135.44°	100.4°

The length of microstrip line from reference to each element is chosen so, to give us the phase shift calculated above. Figure 32 shows a 2 element sub array from the main structure, where it can be clearly observed that both the elements are having different lengths of microstrip lines. The difference between both the lines is *7 mm*. Hence this way the feed network is formed. Figure 31 shows that, the structure can be divided into two halves of upper 8 element array and lower eight element array. The reason behind this is to avoid fabrication and coupling problems. The orientation of both the upper and lower half has  $180^\circ$  phase shift. Hence an extra transmission line of length equivalent to  $180^\circ$  is added to the lower half in order to make both the halves in phase with each other.

### 5.3.5 4\*4 Rectangular Microstrip Patch Antenna Array Results

The simulation results for a  $4 \times 4$  rectangular microstrip patch antenna array, are given as follows;

### 5.3.6 Return Loss

The return loss result can be seen in Figure 34. The plot shows that the array resonates at the frequency of  $2.39\text{GHz}$  with return loss value of  $-56\text{dB}$ . At the frequency of interest, i.e.  $2.4\text{GHz}$ , the return loss value is  $-17\text{dB}$ , which is less

than the threshold value of  $-10\text{dB}$ . The  $-10\text{dB}$  bandwidth of the structures is about  $50\text{MHz}$ .

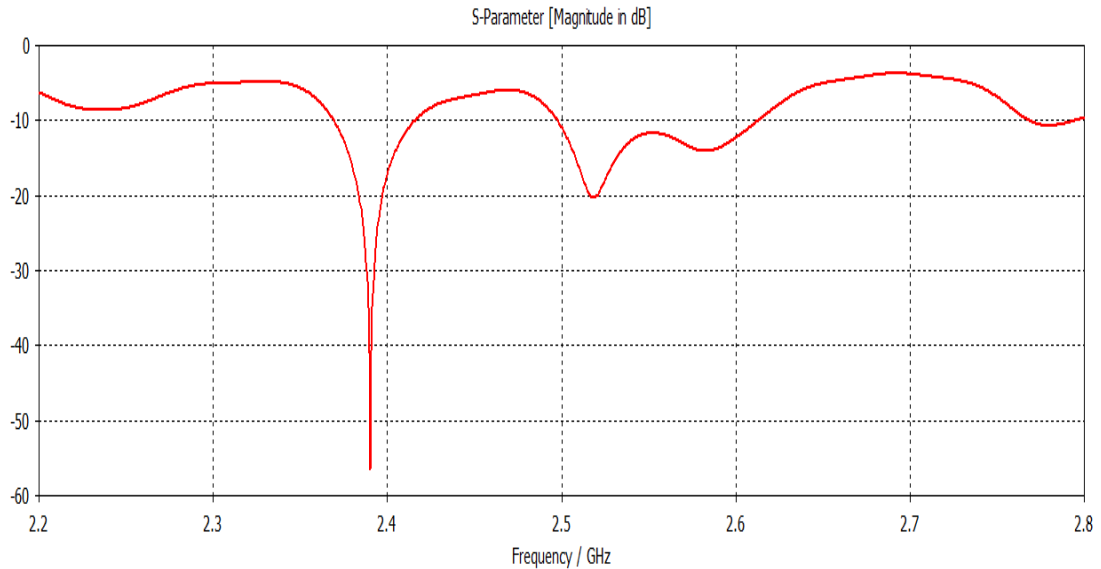

Figure 34: Return loss

### 5.3.7 Normalized Electric Field

The normalized electric field plot can be observed in Figure 35 below. The maximum value of the field occurs at  $350\text{mm}$  away from the aperture. The maximum value of field is  $32.12\text{dB}$ . As the distance increases beyond the maximum value, the field again starts decreasing. The two  $-3\text{dB}$  dip around the maximum value shows that the depth of focus is about  $450\text{mm}$ . While the power level from the point of maximum field to the focal points decrease down by about  $4\text{dB}$ .



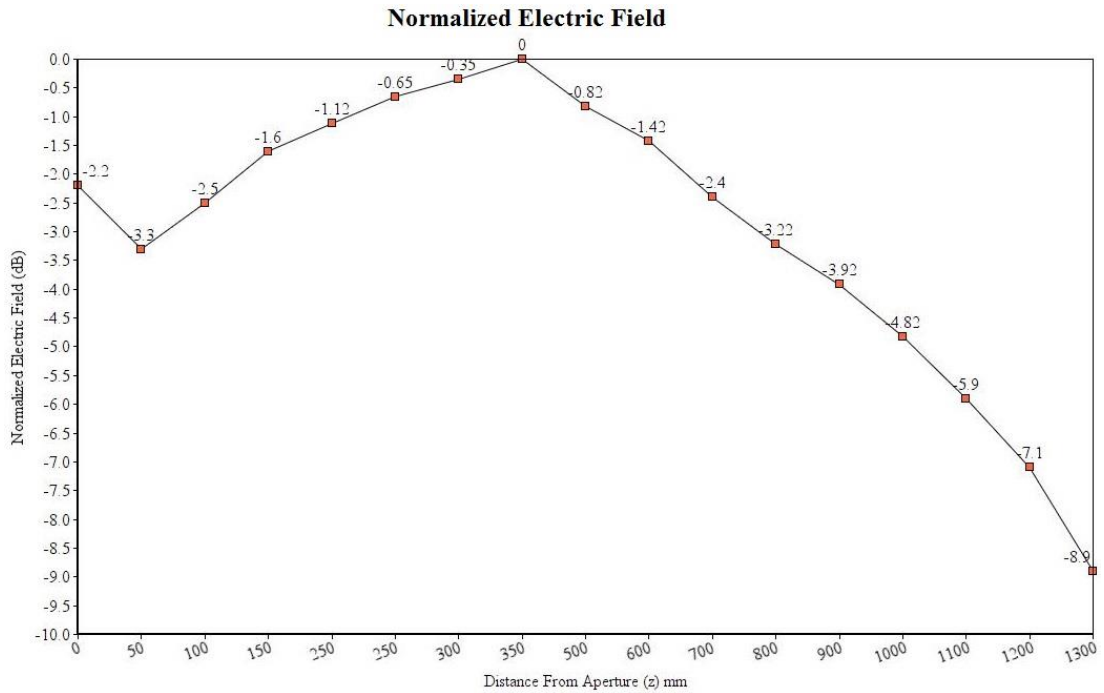

Figure 35: Normalized E-field plot

### 5.3.8 Normalized E-Field Contour Plot

The normalized E-Field contour plots show the E-field pattern at certain distance along the z-axis. This plot provides a clear view of the focused field along different distance from the aperture. Contour plots at distance of  $z = 350\text{ mm}$  i.e. the region of maximum field and  $z = 800\text{ mm}$  i.e. the focal point are given in Figure 36 and Figure 37 respectively.

The normalized E-Field contour plot at  $z = 350\text{ mm}$  shows that the field is focused at the origin, making a spot of focused field. The size of the  $-3\text{ dB}$  spot is  $80 \times 120\text{ mm}^2$ . The maximum value of the field is  $32.12\text{ dB}$ .

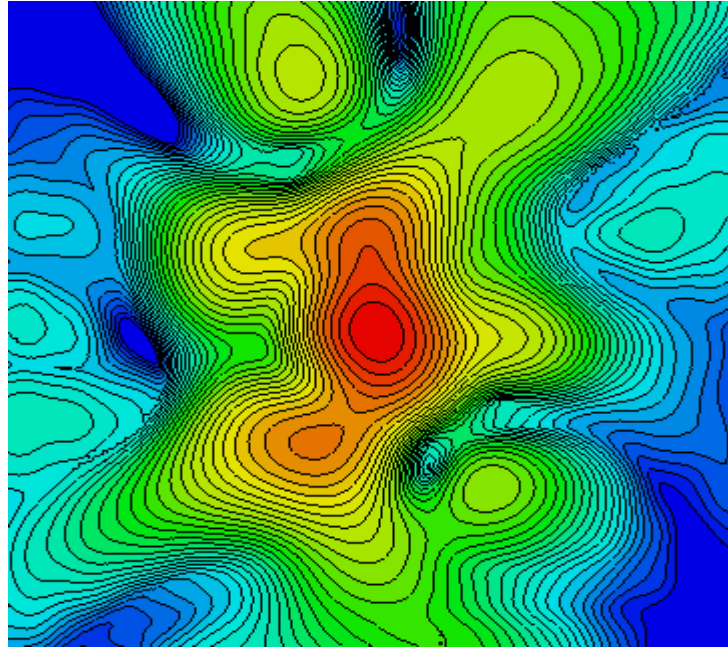

Figure 36: Normalized E-field at  $z=350$  mm

The normalized E-Field contour plot at  $z = 800\text{mm}$ , at the focal point is given in Figure 37. The maximum value of the field is  $28.9\text{dB}$  which shows a decrease of about  $3.2\text{dB}$  in power level. The  $-3\text{dB}$  spot size is calculated to be  $260 \times 260\text{mm}^2$ .

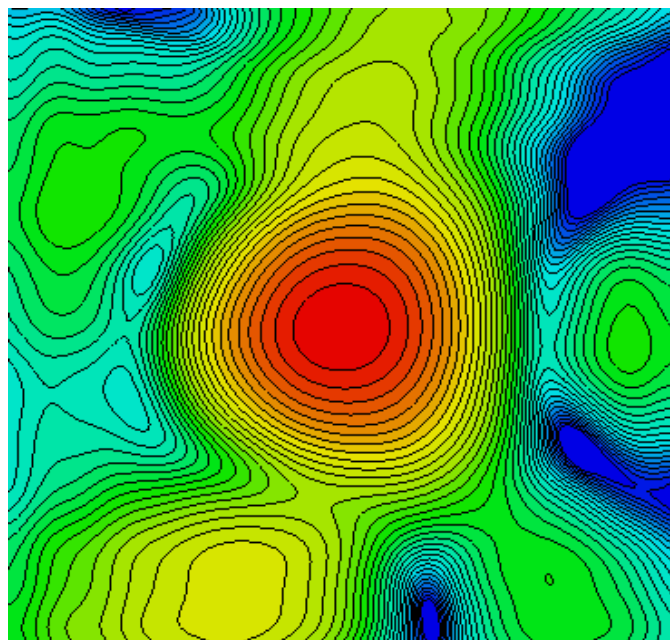

Figure 37: Normalized E-field at  $z=800$  mm

It can be observed from the plots that as long as we go away from the maximum point of E-Field the power level decreases and the spot size increases.

Although far-field radiation is not the scope of this thesis but for the purpose of understanding the far-field and near field  $4 \times 4$  array antenna parameters along with their respective values are tabulated in Table 3;

Table 3:  $4 \times 4$  Array antenna parameters

Parameter	Value
Frequency	$2.4\text{GHz}$
Return Loss	$-17\text{dB}$
Gain	$13.3\text{dB}$
Directivity	$18\text{dB}$

## 5.4 Results Comparison

In order to evaluate the performance of the design, the results are being compared with [10]. In [10] a  $4 \times 4$  rectangular patch antenna is designed. The proposed focal point for both the structures is same i.e.  $z = 800\text{mm}$ . The maximum value of field occurs at  $z = 350\text{mm}$  for our design, while in [10] it is  $z = 320\text{mm}$ . The tabulated comparison is below in Table 4.

The operating frequency for both the designs is taken as  $2.4\text{GHz}$ . It can be observed from Table 4 that the proposed design has better matching than the referenced one. Although the spot at the position of maximum field is not symmetric in proposed design, while in [10] the spot size is symmetric around the origin.

Table 4: Comparison

Parameter	Design in [10]	Proposed Design
Operating Frequency	$2.4\text{GHz}$	$2.4\text{GHz}$
Return Loss at $2.4\text{GHz}$	$-12\text{dB}$	$-17\text{dB}$
Spot Size at Maximum	$100\times 100\text{mm}^2$	$80\times 120\text{mm}^2$
Power Level Drop	$6\text{dB}$	$4\text{dB}$

The drop in power level from maximum position to the focal point is  $4\text{dB}$ , which is comparatively lower than in [10]. Hence it can be concluded that, both the structures have some advantages over each other and limitations as well, depending upon the requirements of the application.

### 5.5 Shifting of Main Beam by Frequency Variation

This design is the modified version of  $4\times 4$  array design. The basic microstrip line length difference remains the same for all the elements of the array. Along the column elements of the array, some extra lengths have been added. The length is in multiples of wavelength. The structure of the design is given by Figure 38.

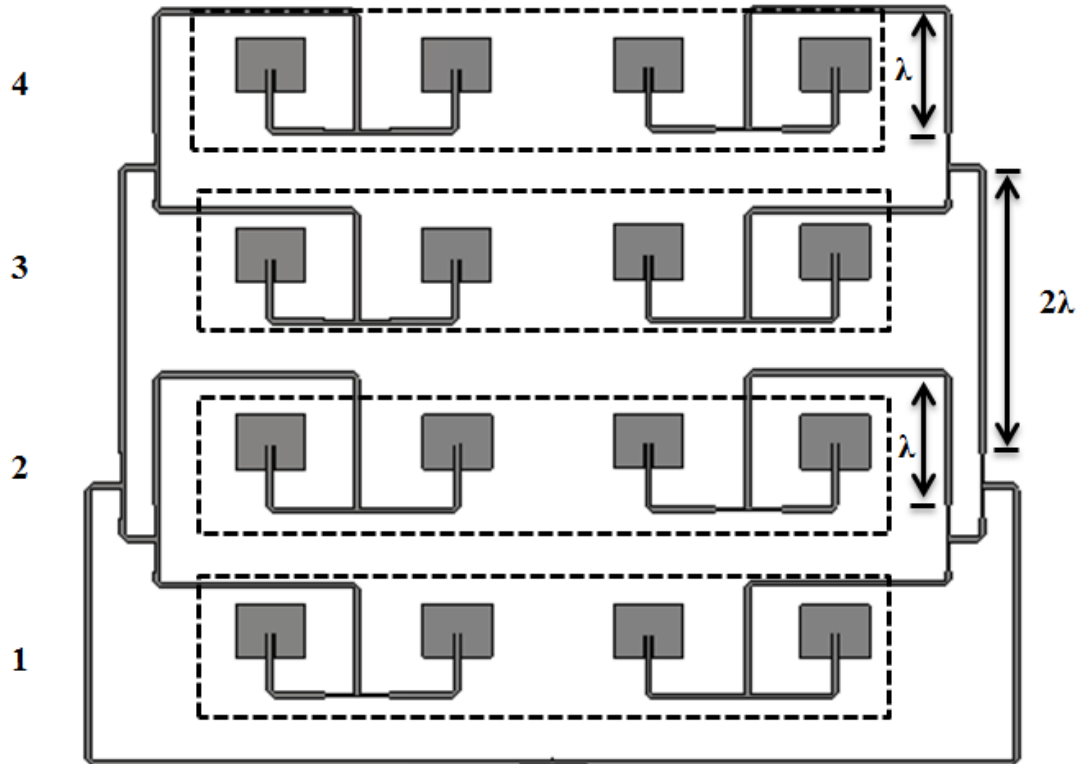

Figure 38: Design structure

The structure is divided here in 4 sections from bottom to top. Each section has the same dimensions as other sections with an extra length of one wavelength added to each adjacent element. Section 1 has standard unit lengths of transmission line. Section two has an extra one wavelength line and so on. If the dimension of section 1 is  $D$ , section 2 would be  $D + \lambda$ , while section 3 and 4 are  $D + 2\lambda$  and  $D + 3\lambda$  respectively.

The reason of the addition of these lengths in to the array is to move the main beam while variation in frequency. Without providing any mechanical movement to the array, the frequency of the system is varied to achieve a change in the position of the focused main beam.

### 5.5.1 Results

The E-Plane plot of the proposed design shows the movement of the main lobe with the variation in frequency. Around the fundamental frequency  $f = 2.4GHz$ , when the E-Plane radiation field is checked, it was found that there is a direct relation between the variation in frequency and movement of the main lobe of radiation. The results are shown below.

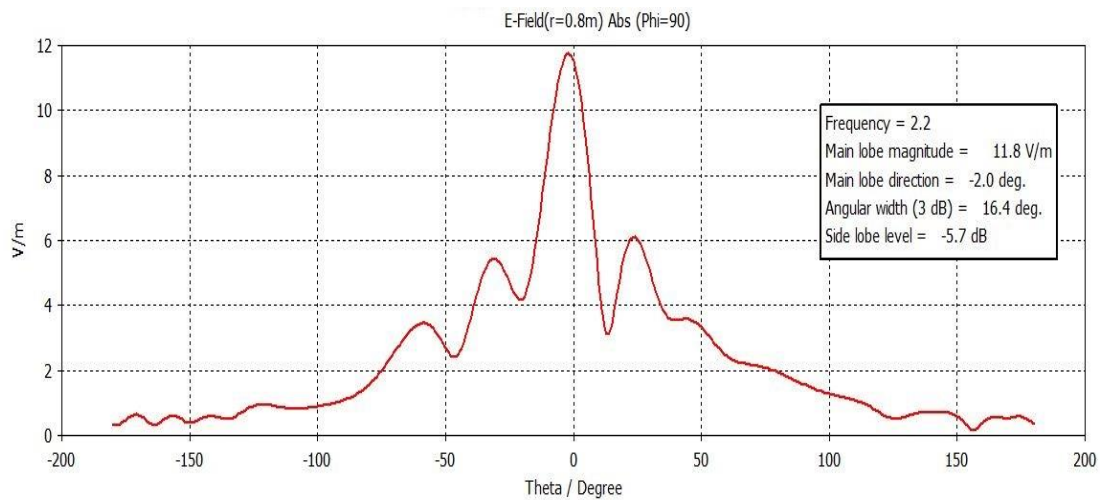

Figure 39: E-Field at 2.2 GHz

Figure 39 can be observed here, that at a frequency less than the fundamental frequency, the main lobe is moved towards the lower side. The main lobe direction is  $-2^\circ$  while the direction of maximum radiation at  $2.4GHz$  is at  $0^\circ$  as shown in Figure 40.

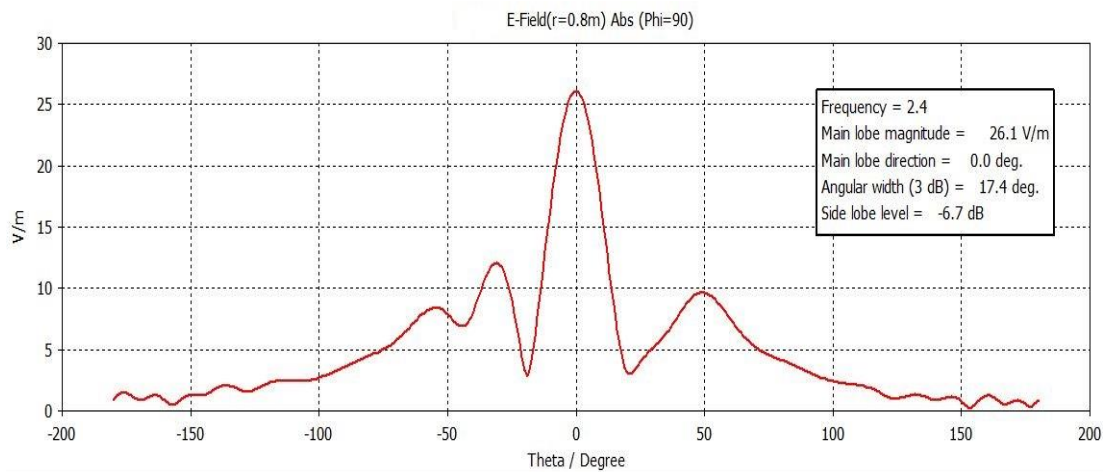

Figure 40: E-Field at 2.4 GHz

When the frequency of the design is increased from the fundamental frequency, the main lobe maximum direction moves towards right side of zero. At 2.45GHz the directions shifts from  $0^\circ$  to  $5^\circ$ . Similarly at 2.5GHz the main lobe maximum further shifts toward right at  $9^\circ$ . Figures 41 and 42 illustrates the theory discussed.

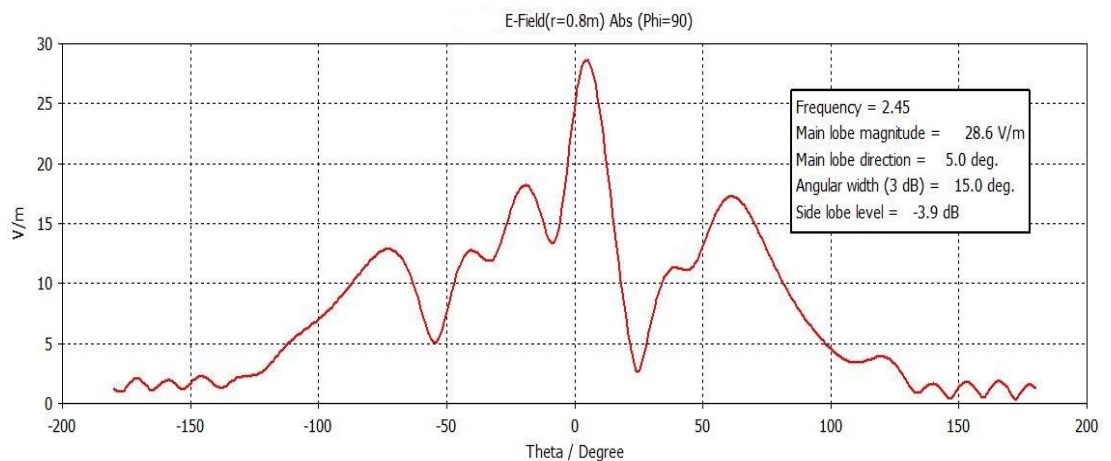

Figure 41: E-Field at 2.45 GHz

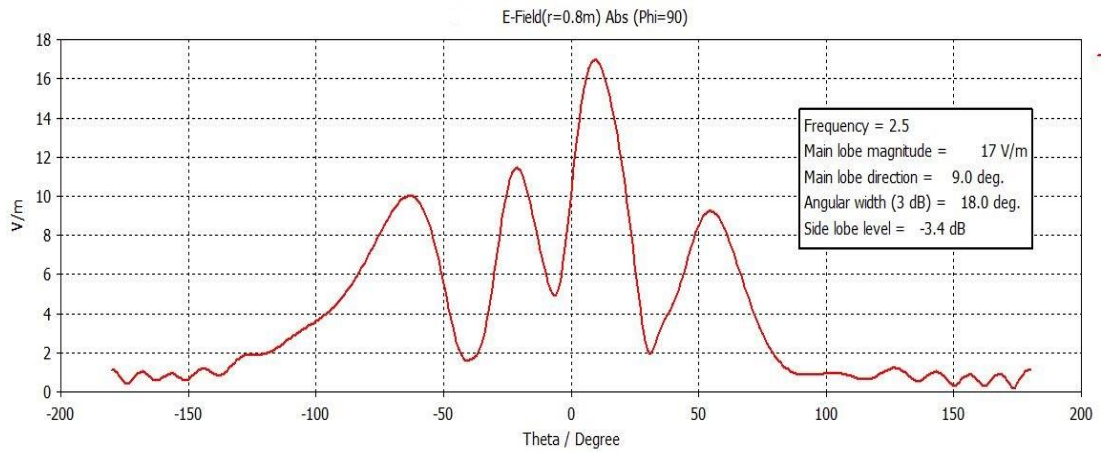

Figure 42: E-Field at 2.5 GHz

However, the control to move the main beam is not accurate. Further studies are being carried to control the movement of main beam direction with variation in frequency. The relation between the variation in frequency and movement of main beam direction will give us an insight of, how much the frequency is to be varied to move the main beam direction for specific degrees.



## Chapter 6

### CONCLUSION AND FUTURE WORK

It can be concluded from  $4 \times 4$  array design that if through proper phase distribution calculated for a focal point in the near field, provided to elements of array, the field of the array can be focused at the focal point. The spot size and the E-Field at the focal point can be utilized in different medical, military and civil applications, such as remote sensing, wireless communication, bio medics etc. Hence there are certain limitations which can be further improved such as size reduction of the focus spot and side lobe level reduction of the overall radiation pattern to enhance the main lobe.

The movement of the main beam in a certain direction along the line of the array is one of the key problems. The proposed work has to be carried in order to achieve the movement of the focused main beam without providing any mechanical movement to the array structure. Although the movement of the main beam is achieved but the control of movement is not accurate. Controlling the movement of main beam with variation in frequency is the future work. The structure as a result of future work will be able to change the main beam of focused spot by only changing the frequency of the structure, having a certain relationship of frequency and spot position variation with control. When the frequency of the structure is changed, the main beam of the spot is supposed to move from its original position to adopt a new position.

## REFERENCES

- [1] Shafai, L., Kishk, A. A., & Sebak, A. (1997). Near field focusing of apertures And reflector antennas. *WESCANEX 97: Communications, Power and Computing, Conference Proceedings IEEE*, 1997, pp. 246-251.
- [2] Chou, H. T., Tung, C., Hung, T. M., Chou, H. H., & Nepa, P. (2010). Design of a near-field focused reflect array antenna for RFID reader applications. *Antennas and Propagation Society International Symposium (APSURSI), 2010 IEEE*, 2010, pp. 1-4.
- [3] Stephan, K. D., Mead, J. B., Pozar, D. M., Wang, L., & Pearce, J. A. (2007). A near field focused microstrip array for a radiometric temperature sensor. *IEEE Trans. Antennas Propagation*, vol. 55, no. 4, pp. 1199–1203, Apr. 2007.
- [4] Loane, J. T., & Lee, S. (1989). Gain optimization of a near-field focusing array for hyperthermia applications. *IEEE Trans. Microwave Theory Tech.*, vol. 37, no. 10, pp. 1629–1635, Oct. 1989.
- [5] Siragusa, R., Lemaitre, P., & Tedjini, S. (2009). Near field focusing circular microstrip antenna array for RFID applications. *Proc. IEEE APSURSI*, Jun. 1–5, 2009, pp. 1–4.
- [6] Buffi, A., Serra, P., Nepa, Manara, G., & Luise, M. (2009). Near field focused microstrip arrays for gate access control systems. *Proc. IEEE Antennas Propag. Symp.*, Charleston, SC, USA, Jun. 1–5, 2009, pp. 1–4.

- [7] Balanis, C. A. (2005). Antenna theory analysis and design. New York: New Jersey: John Wiley & Sons, Inc., 2005.
- [8] Haupt, R. L. (2010). Antenna arrays, a computational approach. Pennsylvania State University, John Wiley & Sons, Inc., 2010.
- [9] Volakis, J. L. (2007). Antenna engineering handbook, phased arrays. McGraw-Hill Professional, 2007 1993 1984 1961.
- [10] Tofigh, F., Nourinia, J., Azarmanesh, M. N., & Khazaei, K. M. (2014). Near-field focused array microstrip planar antenna for medical applications. *IEEE Antennas and Wireless Propagation Letters*, vol. 13, 2014, pp. 951-954.
- [11] Samadi, F. (2015). Characteristic improvement of near-field focused array microstrip planar antenna in ISM band. *Microwave and Optical Technology Letters*, vol. 57, No. 7, July 2015, pp. 1590-1593.
- [12] Lee, K. F. & Luk, K. M., (2001). Microstrip patch antennas. Imperial College Press, London, 2011.
- [13] Gurg, R., Bhartia, P., Bahl, I., & Ittipiboon, A. (2001). Microstrip antenna design handbook. Artech House Inc. 2001.
- [14] Waterhouse, R. (2003). Microstrip patch antenna, A designer's guide. Springer Science+ Business Media LLC, 2003.

- [15] James, J. R., & Hall, P. S. (1993). Handbook of microstrip antennas. Peter Peregrinus Ltd. 1993.
- [16] Douville, R. J. P., & James, D. S. (1973). Experimental characterization of microstrip bends and their frequency dependent behaviour. *1973 IEEE Conference Digest*, October 1973, pp. 24-25.
- [17] Douville, R. J. P., & James, D.S. (1978). Experimental study of symmetric microstrip bends and their compensation. *IEEE Transactions on Microwave Theory and Techniques*, vol. MTT-26, March 1978, pp. 175-181.