

The Evaluation of High-Rise Buildings in Terms of Solar Energy Use

Pooya Lotfabadi

Submitted to the
Institute of Graduate Studies and Research
in the partial fulfillment of the requirements for the Degree of

Master of Science
in
Architecture

Eastern Mediterranean University
April 2014
Gazimağusa, North Cyprus

Approval of the Institute of Graduate Studies and Research

Prof. Dr. Elvan Yılmaz
Director

I certify that this thesis satisfies the requirements as a thesis for the degree of Master of Science in Architecture.

Prof. Dr. Özgür Dinçyürek
Chair, The department of Architecture

We certify that we have read this thesis and that in our opinion, it is fully adequate in scope and quality as a thesis for the degree of Master of Science in Architecture.

Asst. Prof. Dr. Harun Sevinç
Supervisor

Examining Committee

1. Asst. Prof. Dr. Halil Z. Alibaba
2. Asst. Prof. Dr. Nazife Özay
3. Asst. Prof. Dr. Harun Sevinç

ABSTRACT

In recent years, modern societies have not been able to live without energy. So, energy is becoming more and more serious and environmental protection is one of the most important problems in countries' sustainable development. Different types of energies such as thermal, electricity and so on are used in people daily lives. Many of these energy types derived from sedimentary sources like crude oil and coal, which are not interminable. In this case, one of the fundamental challenges of today's world is seeking renewable energy alternatives to be replaced for the fossil fuels, especially for the energy supply of high-rise buildings, which with their vast facades have a great potential for consuming sustainable energies. Thus, the emphasis has been put on the practices and attempts have been done to take advantage of solar radiation as an energy source.

Accordingly, as the planet is suffering from global warming and interminable supplies of energy, finding some methods and principals to diminish energy is truly consequential. For this purpose, surveying and analyzing all aspects of a building's energy use in order to find practical ways to decrease consumption is needed. Hence, the price of fossil fuels cannot compete with sustainable resource costs. The financial and investment costs of renewable energies are still high. So, in order to clarify and study the essential role of the solar radiations in saving energy, due to research limitation three types of high-rise building from use of solar energy in the temperate climate zone are compared. Although there are many appreciable scientific works to solve energy efficiency problems, there are still huge gaps, especially negligence in

analyzing the effectiveness of different active technology and passive strategy criterias, found in high-rise buildings as an imminent part of a new society.

Meanwhile, the author's main attempt is to make viewpoints of some architects more clear about the influences of benefiting from solar energy on high-rise buildings and compare the reliability of these attitudes in the case studies, in order to obtain an environmental friendly pattern of high-rise buildings. Thereby, this study is based on a theoretical approach supported mainly by the outcomes of literature review and case study analysis from the solar design aspects. On the other hand, it is a combination of two main phases; qualitative and quantitative methods of data collection. Finally, as skyscrapers are indispensable in modern cities such as Tehran, Frankfurt and London. Thus, they consume a great deal of energy, considering new ways of benefiting renewable energies can have a vital role in reducing building energy consumption. Furthermore, the results of this research show that sustainable skyscrapers, which are benefited from solar energy design, can be more energy efficient related to use different solar passive strategies - direct solar gain, indirect solar gain, isolated solar gain, thermal storage mass and passive cooling systems - and active technologies.

Key Words: High-Rise Buildings –Renewable Energy Sources –Passive Solar Strategies – Active Solar Technology.

ÖZ

Modern toplumlar, son yıllarda enerji tüketimi olmadan yaşanılmaz bir hale dönmüştür. Bu nedenle, enerji daha da ciddi bir halde ve ülkenin sürdürülebilir kalkınmasında, çevre koruma önemli bir sorun haline gelmiştir. Termal, elektrik ve benzeri enerji kaynakları gibi farklı kaynakçalar ile günlük hayatta kullanılmaktadır. Bu tür enerjilerin çoğu, petrol ya da kömür gibi tükenebilir tortul organik maddelerden elde edilir. Bu durumda, yüksek yapıların sürdürülebilir enerji tüketiminde büyük bir potansiyele sahip olan geniş dış cepheleri enerji ihtiyacının karşılanması fosil yakıtların yerine daha fazla yenilenebilir enerji kaynakları kullanılmasıdır. Böylece, bir enerji kaynağı olarak güneş ışınlarından faydalanmak üzere yapılan çalışmalara ve girişimlere önem verilmiştir.

Küresel ısınma ve tükenebilir enerji kaynakların kısıtlı olması nedeniyle sorun yaşayan dünyada, enerji tüketimini azaltmanın yollarını bulmak ve prensipler geliştirmek gerçekten önemlidir. Bu amaçla, bizler, bir binanın enerji kullanımının tüm yönlerini araştırıp, analiz etmeli ve tüketimini azaltmanın pratik yollarını bulmalıyız. Ancak, fosil yakıtların maliyeti yenilenebilir kaynakların fiyatlarıyla yarışamaz durumda. Yenilenebilir enerjilerin finansal ve yatırım ücretleri hala yüksek olmasına rağmen, enerji tasarrufunda güneş ışınlarının temel rolünü açıklayarak, ılıman iklim bölgesinden üç farklı yüksek katlı bina karşılaştırılmış ve bu şekilde araştırma alanı daraltılmıştır. Enerji verimliliği sorunları ve çözümleri üzerine birçok önemli araştırmalarının mevcut olmasına rağmen, modern toplumun kaçınılmaz öğelerinden biri olan yüksek binalarda, değişik aktif güneş teknolojilerin

ve pasif güneş strateji kriterlerinin etkinliğinin analizi konusunda büyük eksiklikler mevcuttur.

Aynı zamanda, bu çalışmanın temel hedefi, yüksek katlı binalarda güneş enerjisinden yararlanmanın etkileri, uygun yüksek bina örnekleriyle karşılaştırılarak bazı mimarların görüşlerinin ortaya çıkarılmasıdır. Sonuç olarak, bu tez teorik bir yaklaşıma dayalı olup, literatür incelemesi sonuçları ile yüksek bina örneklerinin analiziyle desteklenmiştir. Öte yandan, alan çalışması ve kaynak çalışması olmak üzere iki aşamanın birleşimidir; nicel ve nitel bilgi toplama metodları. Son olarak, yüksek yapılar modern şehirlerin vazgeçilmez bir parçasıdır, çünkü büyük miktarda enerji kullanmaları nedeniyle, yenilenebilir enerjilerden faydalanmanın yeni yolları aramak yapılarda enerji tüketimini azaltma konusunda hayati bir role sahip olabilirler. Ayrıca, bu araştırmanın sonuçları gösteriyor ki, hem aktif güneş hem de pasif güneş yöntemlerden faydalanan sürdürülebilir yüksek yapılar, enerji açısından daha verimli olabilirler.

Anahtar Kelimeler: Yüksek Yapılar - Yenilenebilir Enerji Kaynakları - Pasif Güneş Enerjisi Stratejileri - Aktif Güneş Enerji Teknolojisi.

To My Family

ACKNOWLEDGMENT

This Master thesis was conducted under the kind guidance of Assist. Prof. Dr. Harun Sevinç, who always maintained an open door policy and was available to provide keen insight to theories and concepts confronting me. I am especially thankful for his ability to provide clear and concise explanations of the ecological and sustainable buildings topic traversed throughout this period at Eastern Mediterranean University, North Cyprus.

Further, I have found ways to pass my enthusiasm and growing knowledge of sustainability onto my parents. I am thankful for their attention, support and understanding. I am thankful for the ceaseless supports my parents have provided throughout my life. They have provided guidance continually, unselfishly and are undoubtedly perfect parents. Thus, I would like to dedicate this study to them as an indication of their significance in this study as well as in my life.

TABLE OF CONTENTS

ABSTRACT.....	iii
ÖZ.....	v
ACKNOWLEDGMENT.....	viii
LIST OF TABLES.....	xii
LIST OF FIGURES.....	xiii
LIST OF CHARTS.....	xvi
1 INTRODUCTION.....	1
1.1 Problem Statement.....	2
1.2 Research Aim and Objective.....	3
1.3 Research Methodology.....	4
1.3.1 Scope and Limitations.....	5
1.4 The Study Significance.....	6
1.5 Literature Review and the importance of the Study.....	7
1.6 The Research Design.....	12
2 THEORETICAL BACKGROUND OF THE STUDY.....	14
2.1 Energy.....	14
2.1.1 Energy Concerns.....	15
2.1.1.1 Climate Change.....	17
2.1.1.2 Assessing the Impacts of Climate Change.....	19

2.1.1.3 Measures Against Climate Change Problem	21
2.1.2 Total Global Energy Demand	22
2.1.3 Energy Use in Buildings	27
2.1.4 Conservation, Efficiency and Cogeneration	27
2.2 Sustainability and Renewable Energies	29
2.2.1 Renewable Energy	32
2.2.2 Renewable Energy Systems	34
2.2.3 Renewable Energy Technologies	36
2.2.4 Renewable Energy Alternatives	37
2.2.4.1 Solar Energy	38
2.2.4.1.1 Passive Solar Energy	41
2.2.4.1.1 Active Solar Energy	45
2.3 High-Rise Buildings	46
2.3.1 The Importance of High-Rise Buildings	48
3 THE EVALUATION OF HIGH-RISE BUILDINGS IN TERMS OF SOLAR	
ENERGY USE	51
3.1 Method of the Study	51
3.2 Climate Zones	52
3.3 Case studies	53
3.3.1 Tehran International Tower in Tehran, Iran	53
3.3.2 The Frankfurt Commerzbank in Frankfurt am Main, Germany	56

3.3.3 The Pinnacle Tower in London, United Kingdom	59
3.4 Solar Energy Usage Potential on High-Rise buildings	60
3.4.1 Passive Solar Design Strategies	60
3.4.1.1 Direct Solar Gain.....	60
3.4.1.2 Indirect Solar Gain	68
3.4.1.3 Isolated Solar Gain	71
3.4.1.4 Thermal Storage Mass.....	77
3.4.1.6 Passive Cooling	80
3.4.2 Active Solar Design	82
3.4.2.1 The Tehran International Tower, Iran	82
3.4.2.2 The Frankfurt Commerzbank Tower, Germany.....	82
3.4.2.3 The Pinnacle Tower London, UK	83
4 CONCLUSION	89
4.1 Implications for Further Studies.....	93
REFERENCES.....	95

LIST OF TABLES

Table 1. Case Studies General Information	60
Table 2. Shading Devices Calculation for the Tehran International Tower	63
Table 3. Evaluating Case Studies from the Effect of Direct Solar Gain.....	67
Table 4. Evaluating Case Studies from the Effect of Indirect Solar Gain	71
Table 5. Evaluating Case Studies from the Effect of Isolated Solar Gain	77
Table 4. Evaluating Case Studies from the Effect of Thermal Storage Mass.....	80
Table 7. Evaluating Case Studies from the Effect of Passive Cooling	82
Table 8. The Pinnacle Tower Annual Building Energy Usage	83
Table 9. Evaluating Case Studies from the Effect of Using Active Solar Technologies	85
Table 10. The Evaluation of the Tehran International Tower.....	86
Table 11. The Evaluation of the Frankfurt Commerzbank Tower.....	86
Table 12. The Evaluation of the Pinnacle Tower.....	87
Table 13. The Evaluation of Case Studies in Terms of Solar Energy Use	88

LIST OF FIGURES

Figure 1. World* CO ₂ Emissions** from 1971 to 2011 by Fuel.....	8
Figure 2. Annual and Estimated World Population and Energy Demand	16
Figure 3. Global Mean Temperature Changes	19
Figure 4. 30TW Energy Strategy with Solar and Nuclear Energy.....	20
Figure 5. Simulated CO ₂ Effect with 30TW Solar and Nuclear Energy Application.....	20
Figure 6. Global Warming and CO ₂ Emission.....	22
Figure 7. World's Liquid Fuels Supply.	23
Figure 8. World Oil Production in the Next 10–20 Years	24
Figure 9. Oil Consumption Around the World	25
Figure 10. Perception of Different Energy Usage Sources	25
Figure 11. Shares of CO ₂ Emission by Country	26
Figure 12. Correlation Between Economic Growth and CO ₂ Emission	26
Figure 13. World Primary Energy Supply	31
Figure 14. Illustration About the Major Considerations	32
Figure 15. Stereographic Sun Chart for Tehran as an example.	40
Figure 16. Passive Energy Gain by Solar-Trombe Wall.....	42
Figure 17. Attached Sunspace.....	43
Figure 18: Gasoline Consumption and Urban Densities.....	49
Figure 19. The Four Major Climate Zones	53

Figure 20 & 21. East and South Facade of the Tehran International Tower	54
Figure 22: The Tehran International Tower Site Plan	55
Figure 23. GRFC Wall Section	55
Figures 24 & 25. Tehran Tower Double Glazed Window Detail	56
Figures 26 & 27. The Frankfurt Commerzbank Day and Night Views	57
Figure 28. The Frankfurt Commerzbank Typical Office Storeys	58
Figure 29. The Frankfurt Facade Detail	58
Figure 30 & 31. The Frankfurt Commerzbank Ventilation System	58
Figure 32. The Pinnacle Tower	59
Figures 33. Tehran International Tower Sun Path	61
Figures 34. Egg Crate Shading Devices	62
Figures 35. Frankfurt Commerzbank Tower Sun Path	63
Figure 36. Frankfurt Commerzbank Tower Site Orientation	64
Figures 37 & 38. Frankfurt Commerzbank Tower Gardens	65
Figure 39. Commerzbank Tower Natural Summer Ventilation System	65
Figure 40. Commerzbank Tower Natural Winter Ventilation System	65
Figure 41. The Pinnacle Tower Sun Path	66
Figure 42. Temperature Differentiation, Sunpath and Wind Rose for the Pinnacle Tower	67
Figure 43. The Pinnacle Tower Sunpath and Wind Roses	67
Figure 44. Frankfurt Commerzbank Facade System Details	69

Figure 45. The Pinnacle Tower Multi Layered Facade System.....	70
Figures 46 & 47. The Frankfurt Commerzbank Natural Ventilation Chimney	73
Figure 48 & 49. The Frankfurt Commerzbank Tower Natural Ventilation Chimney Supported by Sky Gardens.....	74
Figure 50 & 51. The Pinnacle Tower landscaped Ramp and Circulation System.....	75
Figure 52: The Pinnacle Tower Building Configuration	76
Figure 53. The Frankfurt Commerzbank Tower Sky Garden	78
Figure 54. Sketch of the Trombe Wall Principle.	79
Figure 55. The Frankfurt Commerzbank Cooling System.....	81
Figure 56. Photovoltaics System.....	84

LIST OF CHARTS

Chart 1. Percentage of the Population in an Urban Area	47
--	----

Chapter 1

INTRODUCTION

Wines (2000), believed that architecture and sustainability go hand in hand. As Antonius¹ (nd), argued “To a rational it is the same thing to act according to nature and according to reason”. Therefore, this statement shapes the initial foundation and motivation in which this master thesis is based on. This research is purposed to deliberate one of the most challenging issues facing humans in near future, so called energy efficiency by paying attention to solar energy in the construction sector. Although there have been lots of appreciable researches to find a solution to this problem, still there are huge gaps, especially lack of attention in analyzing the great potential of high-rise building and skyscrapers, with their vast facades in order to gain solar radiation and benefiting from passive solar strategies and active solar technologies.

Therefore, by considering the use of solar passive strategies and active technologies as an alternative in high-rise buildings, this study tries to fill some of these gaps as much as possible and its proposed fundamental message is changing architects' view in dealing with the subject. After explaining the research aim and the problem, the study's significance will be argued. Then, the method of doing the research will be focused and with the aid of case studies, limitations and scopes of the research will be discussed. Next, the brief and general information about the background of the

¹Marcus Aurelius Antoninus Augustus: A Roman Emperor (161-180 AD) and is also considered as one of the most important ‘Stoic’ philosophers.

issue will be presented. Finally, to reach the conclusion, the research design will be reviewed.

1.1 Problem Statement

One of the fundamental challenges in today's world is substituting fossil fuels with renewable energies. Thus, all the frequent practices have been intensified and efforts have been done in order to utilize the earth and its environment as a source of energy. Unfortunately, architects and planners do not commonly consider it as a source of additional benefits and only little research has been done in order to study the impact of solar energy on the energy demand of high-rise buildings.

Unfortunately, since 1960s the development of high rise buildings, which has practically been energy efficient and respectful to nature has deadlocked. However, after the 1973 energy crisis this attempt has started once more. But, these days, although the importance of energy efficiency issue is apparent, it seems that the majority of architects still have limited interest in energy. In this case Ken Yeang's and Sir Norman Foster's projects - as pioneers - have been very successful in designing high-rise buildings compatible with nature, as a case of solar designed constructions.

Accordingly, the main research problem is to realize the undeniable impacts and effectiveness of using passive solar strategies and active solar technologies that allocate a significant influence on the amount of high-rise building's energy consumption, much better. As a result of height, despite low-rise buildings, high-rise buildings are more directly exposed to the absolute impact of the environment such as solar radiations. Apart from other low-rise buildings, high-rise buildings are the

novel construction type possessing new technologies and of course they must certainly require special design and architecture premises. Therefore, justification for the immense consideration of this research is obvious.

1.2 Research Aim and Objective

In a country's development, one significant role is played by energy. As fossil fuels encompass a very large portion of today's world energy consumption, renewable energies that could substitute fossil fuels have been sought. Correspondingly, in today's world, the rate of energy usage is growing rapidly in accordance with the industrial development, and the population growth is becoming greater. Thereby, as few studies have been done by architects such as Ken Yeang on the amount of energy consumed in high-rise buildings, the author attempts to make viewpoints of some architects clear about the influences of using passive solar strategies and active solar technologies on tall buildings.

Hence, architects and planners have a special responsibility towards energy efficiency development. In this study, the overall objective striven for is to introduce solar energy as a permanent renewable source in order to reduce energy consumption and building initial investment, particularly in high-rise buildings. Thus, the variable output of utilizing both active and passive solar systems and their impact on the decrease of energy usage and total energy demands for cooling and heating the building- as an architectural point of view- should be considered as the main objective of this research and the result could be a new definition of architecture and construction, so that, this branch of industry can supply the necessary contributions for sustainable and viable development.

To sum up, this thesis tries to answer the following questions:

- What are the impacts of benefiting solar energy on the annual total building energy consumption?

This question is the main concern of the research and answering the following two questions help the author to gain the mentioned aim of the study.

- How can passive solar strategies be used to high-rise buildings?
- How can active solar technologies be used in high-rise buildings?

1.3 Research Methodology

This thesis is based on a theoretical approach supported mainly by the outcomes of a literature review and case study analysis. Therefore, the descriptive research method is mainly used in this study. This method is used in order to gather information about the existing type and the amount of energy consumption in the building sector. So, at the first phase, it is a type of study, which is essentially concentrated on describing the degree and the condition of the current renewable energy usage situation in detail.

On the other hand, it involves fieldwork and more especially literature review as a combination of two main phases, qualitative and quantitative methods of data collection. As the first step, the research is performed to become aware about the effectiveness of using passive solar strategies and active solar technologies that architects would like to apply them in the skyscraper design. Then, the study aims to prioritize and compare the effectiveness of these issues by analyzing case studies. In this way, the author tries to do the study through the observation in the case located in Tehran and more specially document survey of all case studies, which is supported by the achievements of former approaches.

1.3.1 Scope and Limitations

The study tries to understand the effects of benefiting passive solar strategies and active solar technologies on high-rise buildings. Therefore, three case studies, which the first one is a nearly normal high-rise building in Iran, the second one is benefiting from passive solar use strategies located in Germany and finally, the last case is benefiting from both solar active and passive technologies and is situated in England. All the selected case studies have mixed-use functions. They are selected in the same climate zone in order to be able to be compared better.

Meanwhile, in this case, the Frankfurt Commerzbank and the Pinnacle Tower were chosen from 'Sir Norman Foster' and 'Ken Yeang' works as a role models in order to find the proper pattern for developing cases such as 'Tehran Tower' in Iran and also other developing countries. They have both formed a new type of energy efficient skyscrapers and have attracted the worldwide attention. They also contest the widespread supposition that tall buildings and constructions are innately energy-inefficient and harmful to the environment. Their high-rise buildings are iconic, and all deviate in major ways from customary buildings. They benefit the rules and principals of energy efficiency in skyscrapers, simultaneously combines the building construction and landscape in a dominant way throughout the entire structure.

Energy efficient design includes not only engineering design but also other disciplines such as architecture. Unluckily, the main concern of high-rise building and skyscraper designers is functionality instead of their environmental impacts (Eisele & Kloft, 2003). Thus, in order to gain environmental friendly design, which leads to economic efficiency as well, there should be a balance between functionality and paying attention to the effects of the building on the natural environment and

vice versa. On the other hand, it is believed that approximately above 30% of building-related CO₂ emission is attributable to the service sector, while this amount is approximately 50% in the residential sector (Thomas, 2006). As there is a time limitation for the research, all cases are selected with mixed-use functions in the temperate climate zone. This is simply in order to compare the case studies in the same climate zone together and also for more clarification on the subject.

To attain an energy efficient construction by benefiting solar energy as a target of the research, three sets of strategies could be considered. The first one is designed for first investment costs, which insists on the energy, equipment and so on, that gives you the efficient first investment costs with low environmental impacts. The second is a so called design for efficient operations costs, which contains energy efficiency by the design configuration with low environmental impacts. Finally, the last part is about end cost and end use, which means the energy and material efficiency during the entire life cycle of the building and recycling them afterward with low environmental effects. The main focus of the study is achieving energy efficiency and lowering the financial costs by developing the first and second strategies. In other words, this research mainly concentrates on the criteria that must be considered in the design procedure before construction level.

1.4 The Study Significance

Unfortunately, nowadays, climate is changing. It is very likely caused by human activities and this shows crucial risks for a vast range of human and natural systems. The addition of each ton of greenhouse gases leads to further changes and greater risks. In this case, buildings consume a huge amount of energy and these energies come from a combustion of fossil fuels, which produce CO₂ in the process. It is also

estimated that building section is responsible for about 40-45% of total delivered energy usage and only a little less than 50% of all CO₂ emissions (Thomas, 2006).

So, as energy efficient building and good design go hand-in-hand, principles like considering solar orientation gives an architect a great foundation on which to establish a more environmental-friendly architecture. Moreover, while designers and architects can fairly easily influence new building architectures by following some simple design principles, this study intends to explore one of the most complex and problematic issues facing humanity over the next century, which is finding the way to construct high-rise buildings in harmony with nature. It deals with renewable energies, energy conservation and etc.

There have been three different factors that motivated the author to do this research. First the matter of energy efficiency itself that tries to guarantee longer access of the next generation to natural resources. Secondly, this fact that architects have a really significant role in designing energy efficient buildings and finally the issue that high rise buildings deserve more attention in the field of energy efficiency.

1.5 Literature Review and the importance of the Study

In recent years, in modern societies, humans have not been able to live without energy. So, energy and environmental issues are becoming more and more serious and the environment protection is one of the most important problems in the countries' sustainable development. Energy sources used in daily life include: electricity, domestic hot water supply, cooling and heating demand (Hacking, 2009). Most of these energy sources, including oil or coal-based fuels are coming from sedimentary organic substances. However, these energy reserves are limited, on one

hand and the fuel prices soaring every day, on the other hand. Furthermore, it is proven that oil can be exploited just for about 50 more years and the coal for about 500 more years (Ke, Qi, & Qi, 2011). Meanwhile, pollution caused by households has a high percentage of the whole environmental pollutants and gases released have tremendous influence on the atmosphere.

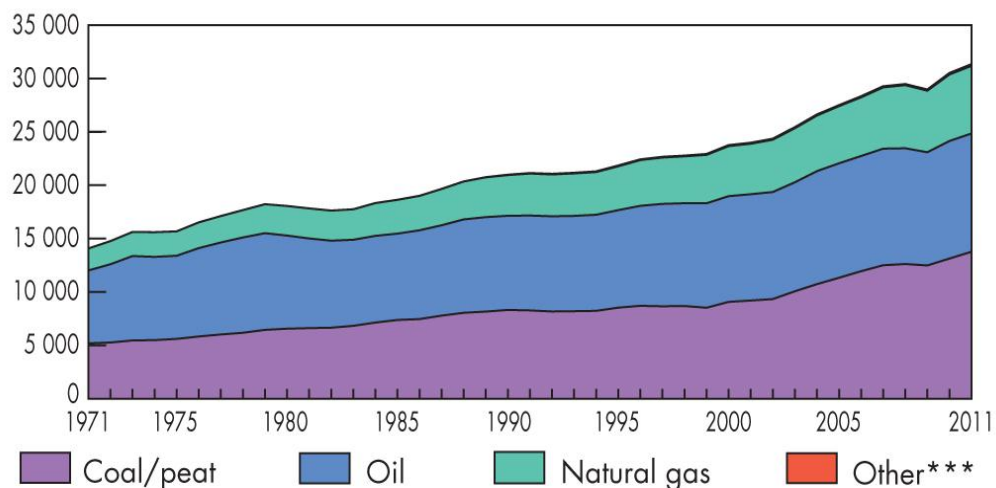

*World includes international aviation and international marine bunkers.
 **Calculated using the IEA's energy balances and the Revised 1996 IPCC Guidelines.
 Figure 1. World* CO₂ Emissions** from 1971 to 2011 by Fuel (IEA, 2013)

The question here is how to manage this great amount of usage. The answer is not keeping on constructing gigantic power stations, consuming enormous amounts of energy sources in one hand, and making equally vast amounts of pollution on the other hand. However, in the case of nuclear power, the high toxic waste should be also considered and if fuel consumption continues at the present rate or follow an increasing rate we will undoubtedly face global vulnerability. The meaningful long term strategy for getting a handle on the world energy usage is to build constructions in such a way that consume the least possible energy.

The world average temperature has gone up to 0.8°C since the beginning of the 20th century, while two-third of this increase has occurred since 1980 (America's Climate Choices, 2011). This reality converses 'Global Warming' to a crucial matter. This term can simply explain the rise in the mean temperature of the world atmosphere. Accordingly, nowadays, the globe is threatened by global warming and energy sources have a vague future. Therefore, it is so essential to find methods to reduce energy usage.

It is believed that the energy consumed in buildings, both in construction and their usage section, leads to producing approximately 40% of the greenhouse gases. Moreover, in industrial countries, about 40% of the total energy is spent for building needs and about 10% of energy usage is added to this amount for the materials' production, construction processes and the materials transportation (Hegger et al, 2008). It shows that, even today, they must be precisely managed in construction and running according to the principles of climatic aspects, energy efficiency and sustainability.

Nowadays, the necessity of living and thinking about energy efficiency in order to save inheritance and resources for our children and the next generations is mostly approved. This refers to every aspect of the natural environment and also building section. In order to create and develop sustainable society, one possible alternative is to consider saving energy necessity in the construction section (Randall & Fordham, 2006). Although there is a great susceptibility in the construction section, there is no doubt that architects have come upon this issue late.

The consideration of the climatic issues in the official education system began in the late 1960s. Most probably the main reason for this neglect was the cheap price of oil and other fossil fuels before the energy crisis of the 1970s, which architects could easily reach the interior comfort level of their buildings without being responsible for considering the climate in their designs. After the energy crisis (1973), alternative sources of energy were pioneered with new legislation encouraging research and development to deal with the problem. The fact that these resources won't last long, has gradually led people to think more about the way they exploit nature and little by little architecture has been involved in a debate about energy use that is becoming louder by the day. But still there have been numerous positive advances (Emadi & Lotfabadi, 2011).

For this purpose, to find out practical ways to decrease energy usage in buildings, all aspects of its energy consumption must be analyzed. “Renewable energy is the energy, coming from natural sources such as solar radiation, wind, tides, rain, geothermal heat and so on, that are naturally replenished” (Doji et al. 2011). In recent years, a lot of attention has been paid to renewable energy sources since sedimentary fossil fuels have been exploited too much and fuels crises have occurred, which encourage developed countries to welcome renewable technologies. As this kind of energy is renewable, it can be assumed as sustainable. In other words, it will never run out and it has minimal impact on the environment (Bauer, Mösle, & Schwarz, 2010).

It is obvious that increasing the consumption of renewable energy resources and also their integrated operation is an essential factor in obtaining the long-run purposes of energy. Buildings could be ‘environmental friendly’ and attain ‘zero emission’ by

applying renewable energies as power sources (DCLG, 2009). Thus, studies on energy management and renewable energies play such a significant role in this process.

On the other hand, as population grows, more buildings are used as shelter and high-rise buildings gain inevitable importance. Accordingly, high-rise buildings had been more noticeable for such reasons as being more compact, which reduced land use, transportation and much safer against physical destructive phenomena, such as fire and earthquake, more economical and so on. Therefore, each factor played a fundamental role in encouraging the growing population to move into high-rise buildings.

Finding renewable energy sources is essential. Especially in high-rise buildings, which have an incredible potential for using sustainable sources such as solar energy, because of their vast facades, which provide a great area to benefit. New design ideas are becoming common among pioneer architects and developers. Well designed bioclimatic skyscrapers are to be related to their sites and to have energy efficiency. New constructions offer more comfortability for their occupants during the whole year.

Consequently, one of the fundamental challenges for the future is energy efficiency issue and taking an approach towards the nature. In order to gain this purpose, there should be an attempt to find environmentally friendly energy supplies, which are both easily accessible and compatible with climatic conditions. Apart from new and more efficient technologies, which are currently used, more emphasis will be needed to be placed on reducing energy consumption and also on source requirements

without diminishing either living standards or comfort level. Architects and designers have to face these substantial challenges. Thus, the aim is achieving maximum overall comfort and living quality with the minimum energy and resource usage.

As time passes, human beings gradually obtain a deep understanding of the reasons for their existence on earth, become aware of this fact that we must live responsibly and become conscious of our duty towards the environment as well. Architecture must be truly responsible for the present time and its special requirements. Meanwhile, high-rise building architects should follow up natural patterns and try to make a balance between the natural environment and human beings (Özay, 2005). This is in order to teach the profundities and beauties of the environment and also illustrate the physical and spiritual embodiment of human dignity. Thereby, the re-consideration of organic architecture should consider solar energy, could present new freedom of thought and also an expression of hope for the future in every aspect of life.

1.6 The Research Design

This thesis tries to explore the effects and benefits of utilizing passive solar strategies, active solar technologies and also daylighting effects on designing high-rise buildings. Therefore, it is structured in four sections. As discussed, the first chapter was about the main purpose of the research in order to clarify its significance. Afterwards, the next chapter is about initial definitions, the theoretical background of the study and is also about the previous attempts to solve the problem by other researchers, which will be presented. Then, in the third chapter, the author tries to discuss the gap of the previous researches by analyzing the case studies.

Finally, in the concluding part, after presenting a brief summary of the study, it will be tried to answer the research questions.

Chapter 2

THEORETICAL BACKGROUND OF THE STUDY

2.1 Energy

Although concern for the energy conservation was meaningful in the early 1970s buildings, the trend was wounded as fuel supplies returned and cheapened. Though, today, with the realization that all fuel burning release the greenhouse gases, the pressure has redoubled (Saxon, 1994). In this chapter, the importance of buildings in energy use and CO₂ production is indicated. In the following sections, the ways of reducing energy consumption in different types of buildings will be introduced.

From a historical point of view, up to a few centuries ago, the relationship between the natural environment and human beings were described by human willingness to adapt to the environment and to live in harmony with the environment. In comparison with the contemporary situation, the comfort requirements and demands were really different in the past. This was because, that humans were not primarily capable to tame nature to the present possible level (Talbot, 1997). Thus, the rules and principles defined in this section, give the possibility to know the mechanisms of nature better, and in a way that can be benefited for the construction's design and their relations to the nature.

Eventually, by considering today's global economy, no one doubts that current energy sources are not interminable. An architect, the necessity of sustainable design for the future is inevitable. Moreover, in theory, this potential is available by energy

efficient design, which can cause the design to change from being uncertain into a confident science. This kind of energy conservation might be meaningfully reached in high-rise building design.

However, this kind of view to the energy matter is just a part of the complicated environmental design. Likewise, from an architectural point of view for low energy consuming constructions three routes can be considered, which are: First, the material and component selection during the construction operation. Second, supplier economics (for example a life cycle approach from source to sink), or even through basic design (Hamzah & Yeang, 2000). The last point provides a base in order to explain the constructions' configurations, especially in tall buildings.

2.1.1 Energy Concerns

Energy sources have performed necessary functions, such as creating heat, supplying drinking water, generating power for certain appliances, electrical products and so on. With efficiency in mind, it is worthwhile for us to create tools, that can produce usable energy without excessive consumption. This means striving to equalize the power input and output of a given system, so that, the running of the system consumes no more than is absolutely needed to perform the intended function with minimal or no residual waste (Tsui, 1999).

Moreover, the energy part consists of several different factors that can be meaningful in determining the amount of energy consumed and produced in the future, in both developed and developing countries. For example the most remarkable factors are population growth, consumer tastes, economic performance and technological developments. Moreover, governmental policies can highly influence the future of different energy sources, both in production and consumption aspects (Dincer, 1999).

Accordingly, in recent years, energy demand is growing. It is certainly because of the annual population growth rate (Fig. 2), which is now about 2% and is also more in some countries. This quantity is expected to double by 2050, and improving standards of living by continuing economic development, must be considered as a result. Also, by 2050, global energy services demand will increase up to 10 times, while primary energy demand is anticipated to intensify by 1.5 to 3 times (Anon, 1995).

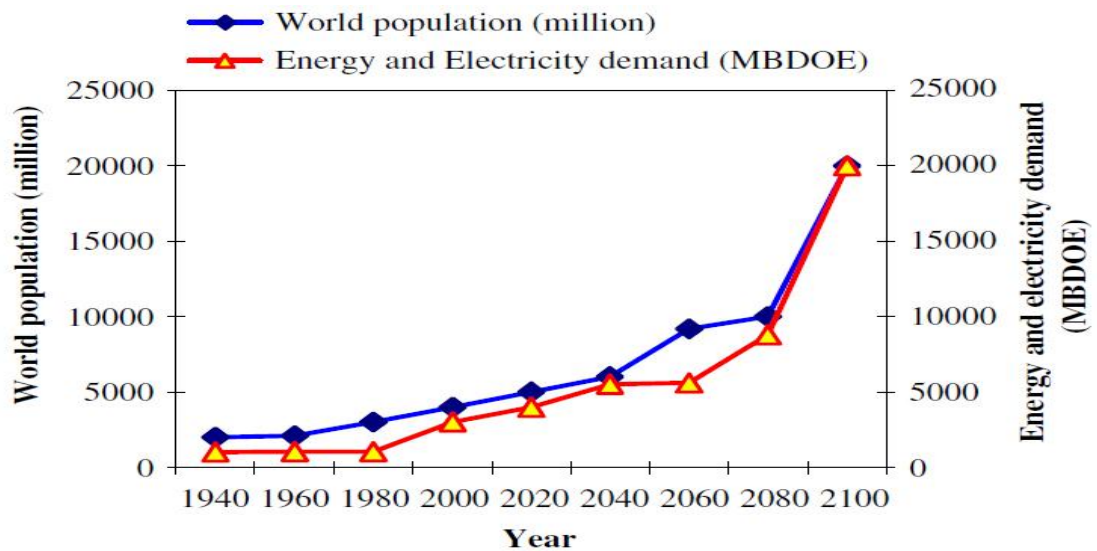

Figure 2. Annual and Estimated World Population and Energy Demand (IEA, 2006)

Thus, more environmental considerations should be taken from the public and industry section, both in developed and developing countries. It is believed that in future people will become aware about pollution problems and take responsibilities, in order to account the environmental costs, some energy source's price has multiplied. Consequently, estimations show that both primary energy demands and global energy service needs are growing. At the same time, people will be more concerned about climate change in the future and its causes such as acid rains, stratospheric ozone depletion and so on (Dincer, 1999).

2.1.1.1 Climate Change

Another probable challenge at the present time and also future is climate change. It represents an essential factor in order to unite long term thinking and structural energy design. Accordingly, energy policies have distinctively emphasis on mitigation such as decreasing greenhouse gases by applying energy saving measures and low carbon technologies (Lang LaSalle, 2010).

Climate change, which specifies different parts of the world, refers to a change in weather patterns not in a short time (URL1, 2012). Experts believe that the world is going warmer (global warming). This trend cannot just be explained by natural climate variability. Human activities, especially, burning oil and coal have made the planet warmer (DEFRA, 2007). This has occurred because of heat being trapped in the atmosphere, so the more greenhouse gases are produced, the warmer the planet will be.

Global warming effects can be seen in almost every place on the earth, from melting snow and ice to rising sea levels or changing weather patterns and so on. Unfortunately, climate change has already affected ecosystems, human health and freshwater supplies. Although it is not possible to avoid climate change entirely, by substantially declining the heat-trapping gases, which are released into the atmosphere, its most severe effects can be avoided. However, each day, the time available to commence required action to escape severe global outcomes is growing shorter (Frenside, 2007).

Climate change is described as a statistical consequential variation in the average climate or in its variability, insisting on an extended period, at least a decade.

Therefore, some natural internal procedures or external forces, and also some kinds of human based activities convert the climate change to a critical problem. Since a long time ago, this problem has stopped to be just regulatory scientific concern (Chauvin, 2008).

Since the industrial revolution – about 150 years ago - man's interferences in the nature has caused the planet to get warmer. The intergovernmental panel on climate change says, during 250 years (1750-2000), the concentration amount of some of greenhouse gases such as CO₂, NO₂ and CH₄ have grown orderly about 31, 17 and 15 percent in the atmosphere. This increase leads to making a stronger phenomenon named global warming.

Scientists believe that the amount of increase in temperature during the last 20 years has been about 0.6°C. They also believe that during their measurements the 1990s have been the warmest decade. Unfortunately, it seems that it is the growing crisis, which affect human's whole life from food production, health and safety to the economy and so on. For instance changing the weather patterns, leads to changes in ecosystems and also increase the sea levels, which affect the water supplies and increase the possibilities of floods and many other chaining factors, which can individually affect the life cycle (Goic, Iniyana, & VenkataRaman, 2012).

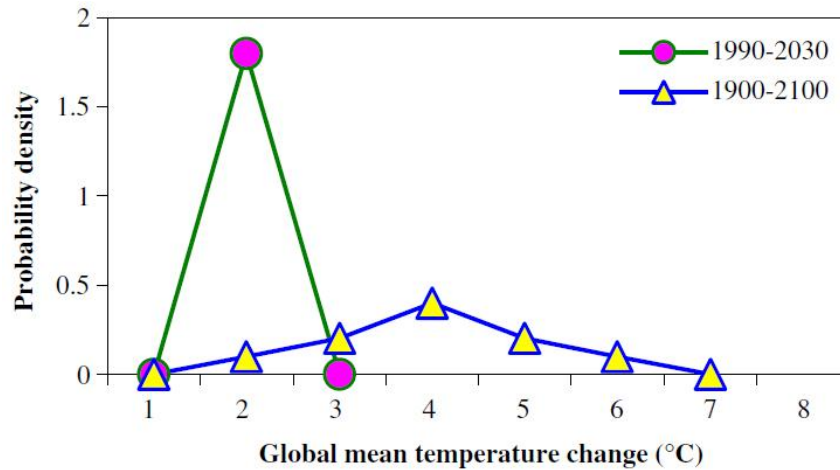

Figure 3. Global Mean Temperature Changes (IEA, 2006)

2.1.1.2 Assessing the Impacts of Climate Change

Studying the impacts of the spread of greenhouse gases and global warming makes it vivid that many catastrophes roots from this so called ‘global warming’ phenomenon. Chauvin et al. (2008) believed that the anthropogenic spread of aerosols and greenhouse gases have speeded up the climate change in the present century. For instance the number of frost days will be decreased, length of seasons will grow, that leads to have a tendency for drought duration and change the wind related extremes. The dramatic change that the arctic has undergone during the past decade, including atmospheric sea level pressure, wind fields, ice cover, the length of the melt season, sea ice drift, change in precipitation patterns, change in hydrology, change in ocean currents and water mass distribution (Fyfe, Harner, & Macdonald, 2005).

Climate in permafrost regions near surface thermal streams change significantly (Anisimov, Nelson, & Shiklomanov, 1997). For example Bershanskii proposed a series of transformations in the solar convective area to illustrate the results of the

increase in sunspot number and based on this, he suggested a way to forecast global warming (Bershanskii, 2009).

Thus, although using nuclear power is still a great debate, the imagination of the world that substitute fossil fuels with solar and nuclear energies, while at the same time, the global energy usage increase to 30TW as well as resulting estimated CO₂ emissions and temperature shifts worldwide is demonstrated in figures 4 and 5.

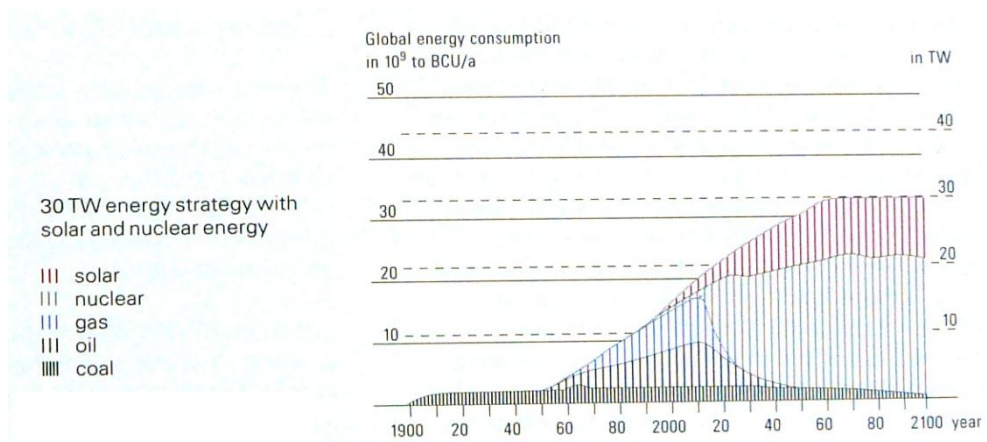

Figure 4. 30TW Energy Strategy with Solar and Nuclear Energy (Daniels, 1997)

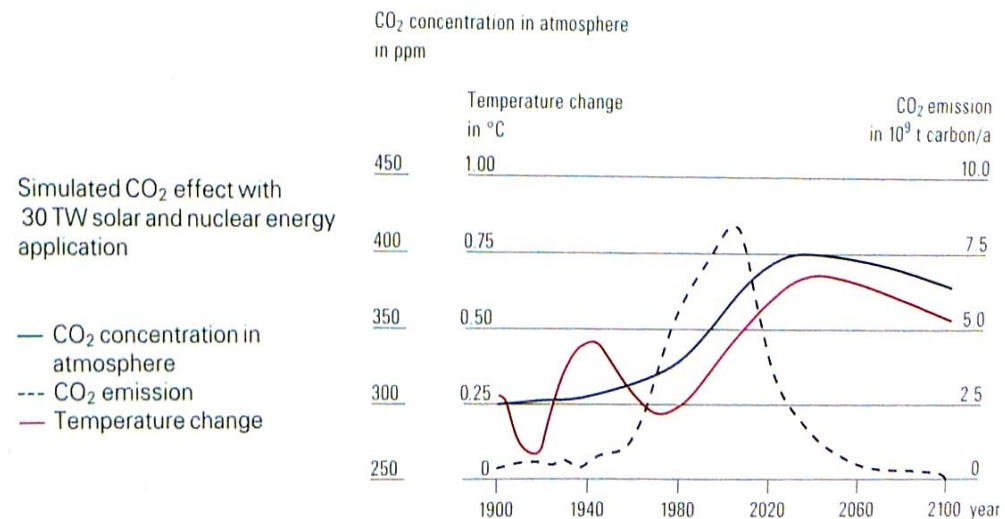

Figure 5. Simulated CO₂ Effect with 30TW Solar and Nuclear Energy Application (Daniels, 1997)

2.1.1.3 Measures Against Climate Change Problem

The core of the problem in terms of carbon dioxide emission per head lies in the developing and industrial countries inequalities. Generally, CO₂ emissions from developed countries are displaying less sign of decreasing (Boardman, 2007). The US average emission is 23% of the world's total now, which is twice the European average and is still increasing. The average citizen in the North American continent, which includes US, Canada, Mexico and so on, annually adds nearly 6 tonnes of carbon to the atmosphere per year. This is about 2.8 tonnes per person in Europe (IEA, 2013).

Although we have started from a very low base, the most rapidly rising per capita emissions are taking place in Southeast Asia, India and China. The Kyoto Summit was squeezed down to agreeing a mere 5% global cut in CO₂ emissions based on 1990 levels, yet the UN IPCC scientists stated that in order to stop global warming a worldwide cut of about 60% would be necessary (Smith, 1988).

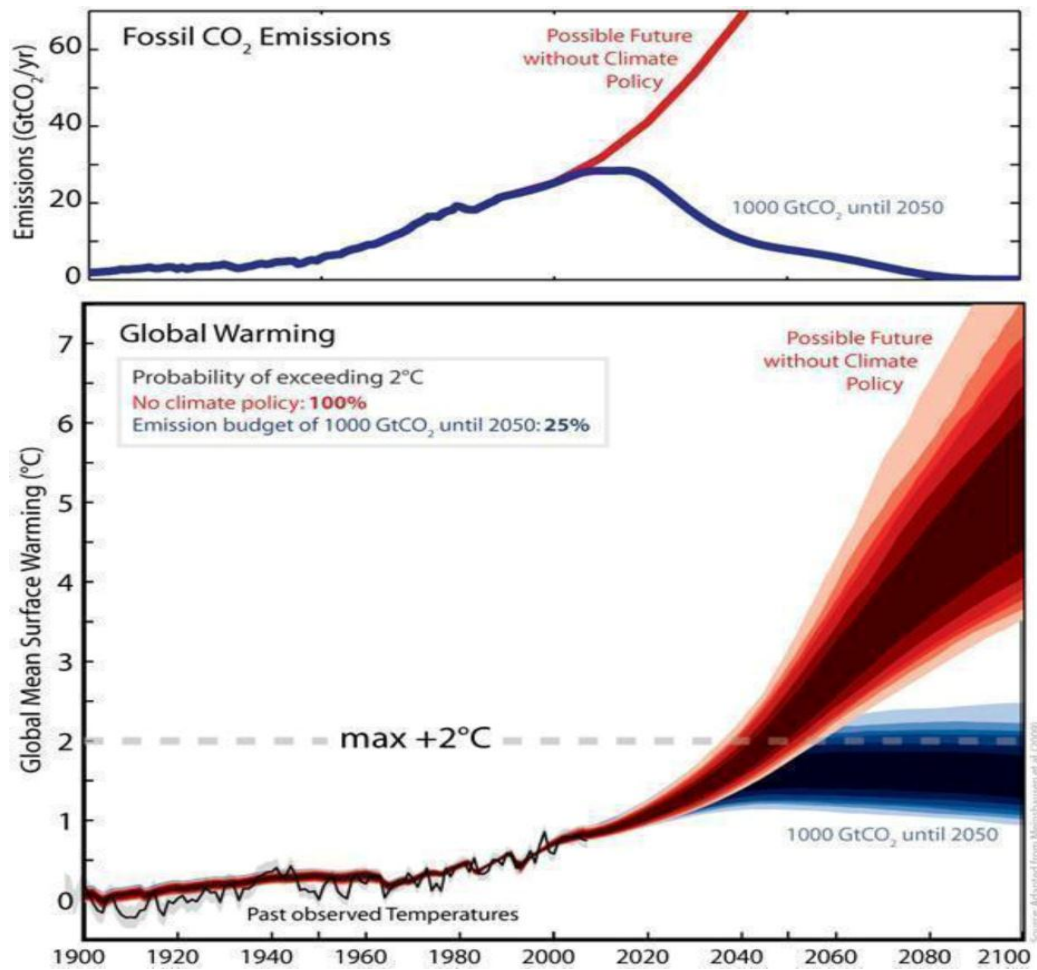

Figure 6. Global Warming and CO₂ Emission (*Barnett, 2013*)

2.1.2 Total Global Energy Demand

Today 80% of the world's energy use is based on fossil fuels. During the past centuries less fuel was consumed and this portion related to the present century. The amount of oil consumption has increased since 1990 together with natural gas consumption. So, at the end, the total amount has increased. It is clear that these natural resources will end up one day (Fig. 7). The allocation of solar energy increased and the rate of renewable energies remained static. In 1990, the portion of biomass and waste was about 11% and it is still the same today. If we deduct the traditional biomass from the total amount of renewable energy forms such as wind, solar energy, hidden energy in tides and geothermal energy, we get 0.45% of world primary energy use in the same year. This share is 0.55% for 2006. Although the

share of renewable energies has doubled since 1990, it is really a very poor performance (Jefferson, 2008).

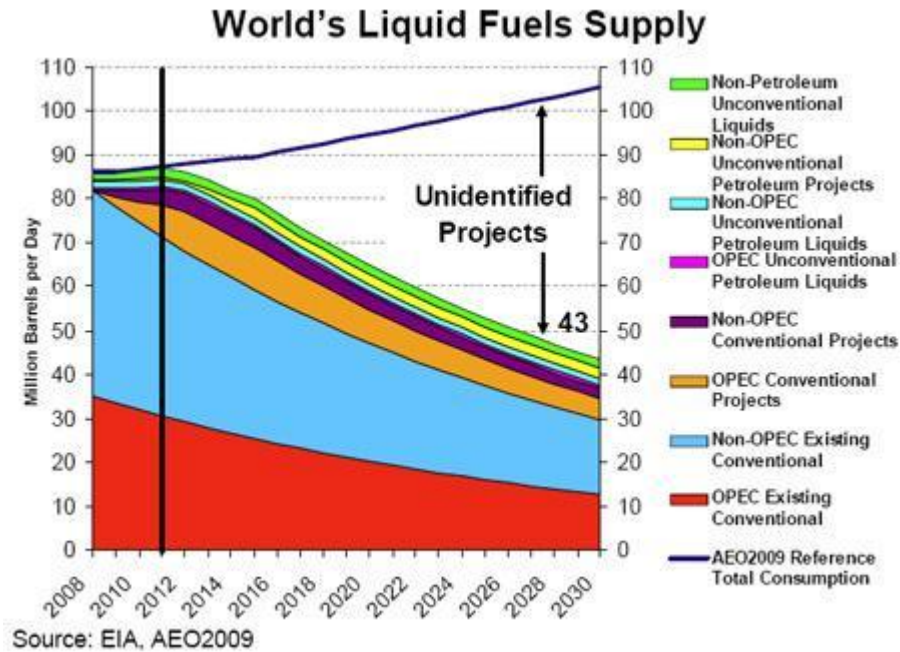

Figure 7. World's Liquid Fuels Supply (Hannan, 2010).

Based on the present data (2008) total energy consumed per year is more than 131,138 PWh² or 473,500 EJ.³ The oil's share is 35%, natural gas's is 20.7%, nuclear sector generates 6.3%, hydro energies consists 2.2%, waste and biomass produce 10%, coal has a share of 25.3% and other sources generate 0.5% (IEA, 2008). In recent years, mankind has welcomed the use of renewable energy sources due to the fuel crisis caused by its price increase and global warming (Bakic, 2011).

It is estimated that oil reserves would approximately be between 3 to 4 trillion barrels (Jefferson, 2008), which cannot fulfill our needs more than about 45 years. Other estimations declare that the time will be perhaps 10 years less than the previous estimations, however, considering the most widely accepted estimations, 3 trillion

²PWh: Peta Watt Hour

³EJ: Exa Joule

barrel oil reserves will come to an end approximately in 35 years (Fig. 8) (Jefferson, 2008).

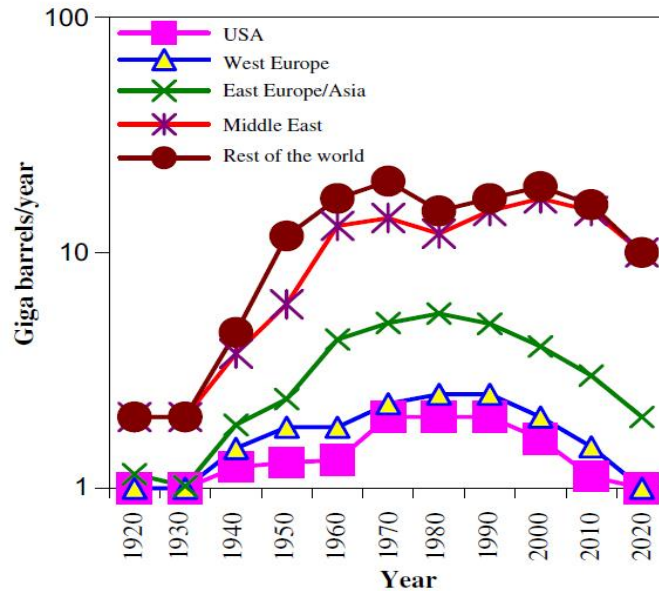

Figure 8. World Oil Production in the Next 10–20 Years (Kano, 2006).

According to the ‘International Energy Agency’ (IEA) the oil resources will end up in about 2040; meaning that the oil consumption will increase up to 40% between 2006 and 2030 (IEA, 2006). The world has used about 800 billion barrels of conventional oil so far and the cumulative total is approximately 900 billion barrels. The resource base of conventional oil is precisely estimated to be 2 trillion barrels, so only 300 billion barrels would be left by 2030 and this amount is enough only for ten years supply (Jefferson, 2008).

Figure 9 gives a global breakdown of how much petroleum is used by countries, regions and continents. It also illustrates the direct portion of population growth with the per capita annual oil usage.

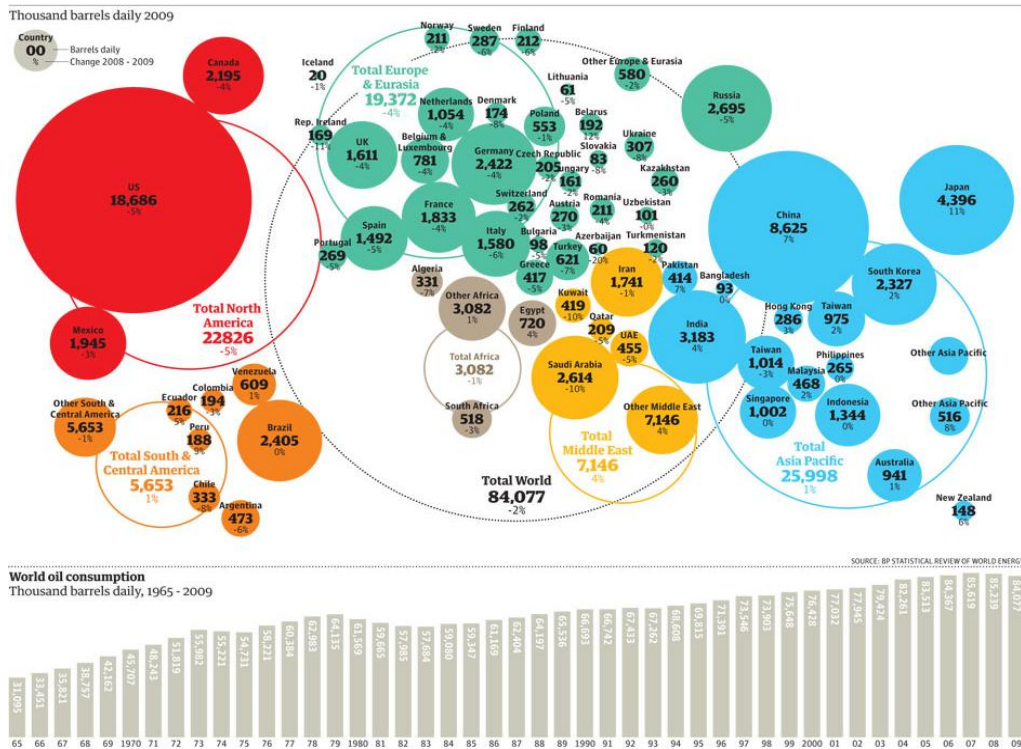

Figure 9. Oil Usage Around the World (URL2, 2013).

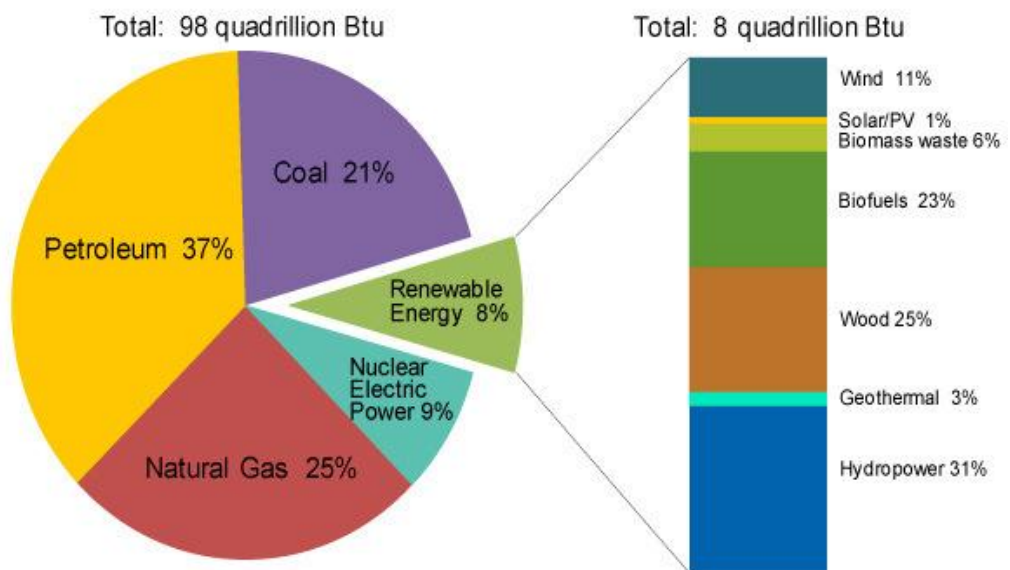

Figure 10. Perception of Different Energy Usage Sources (Year 2010) (Parent, 2012)

According to the above information, in 2002, renewable energy sources represented about 8% of the global energy consumption (Parent, 2012). Though, as it is illustrated in figures 11 and 12, these amounts are quite different in developed and developing countries, which lead to different amount of CO₂ emission in such

countries.

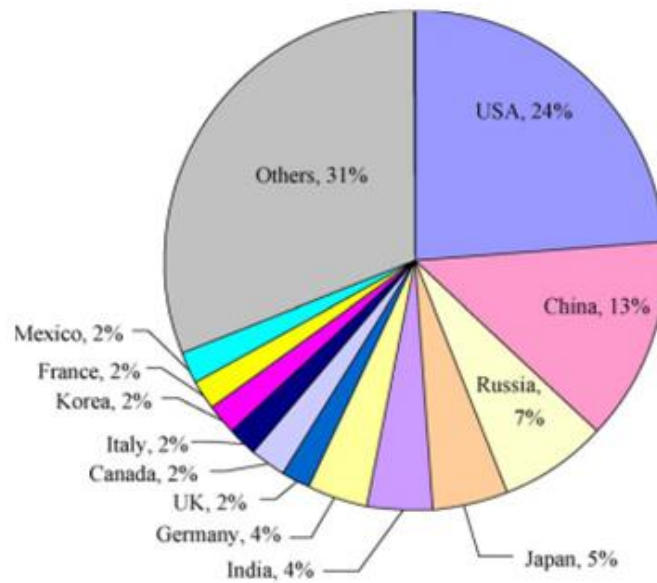

Figure 11. CO₂ Emission Shares by Country in 2001 (Kanoh, 2006).

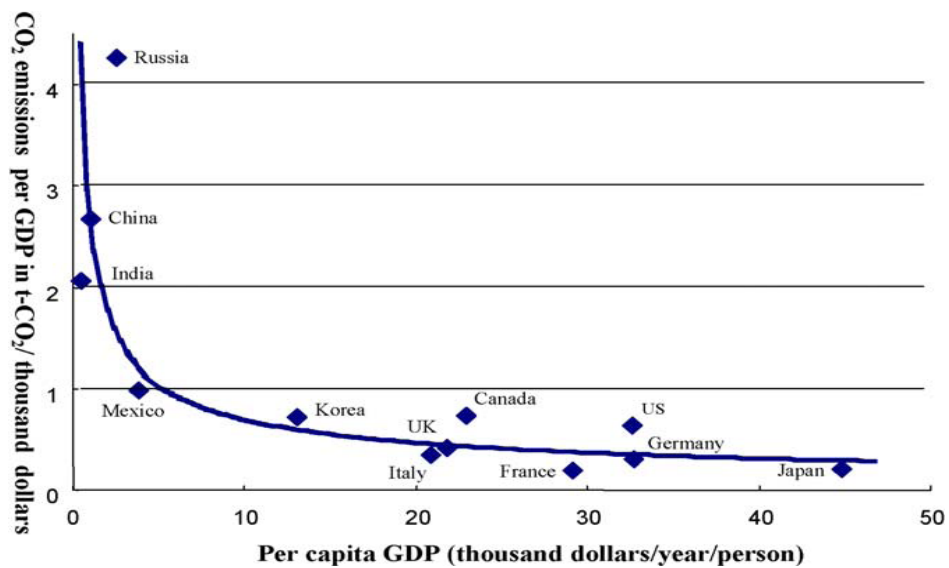

Figure 12. Correlation Between CO₂ Emission and Economic Growth (12 Biggest CO₂ Emitters) (Kanoh, 2006).

In a superficial analysis, it would seem that developed countries, such as Germany and Italy were in a better situation than OECD ⁴ones regarding renewable energy supply (Goldemberg & Coelho, 2004).

⁴OECD: Organization for Economic Co-operation and Development

2.1.3 Energy Use in Buildings

In general, in every construction process level, there are four different levels of impacts on the environment. They can be considered as the impacts of inputs, impacts of outputs, impacts of the system and finally impacts on the environment itself on the system. To be more clear, in the construction sector, it can be seen that about 40% of the raw materials by weight are used in this part globally each year (Doji et al, 2011), and also between 36 to 42% of a nation's energy output is used in constructions.

As building outputs something about 20-26% of landfill trashes are from buildings, and finally 100% of energy, which is consumed in buildings is lost in the environment (Chan Y. , 2007). Therefore, to have more control on energy usage in buildings, the role of architects is significant to make towards the improvement of the environment and also regarding to a more ecological future. This issue - energy - is important for architects because the building section itself represents about 40% of the total energy used throughout the entire world (Scott, 1998).

2.1.4 Conservation, Efficiency and Cogeneration

Predicting energy consumption and demands is nearly impossible because of the permanent change in technology, economy and social assumption underlying projections. Energy consumption reaches the peak both in summer due to the air conditioning systems and in winter due to the heating. These variations should be considered. Thus, this pattern would change in accordance with the population growth and conservation measures and it is believed that better designs for constructions and considering renewable energies are helpful (Kaygusuz K. , 2003).

Considering these facts, to choose an evolutionary approach to architecture, we have to recognize the distinctions between limited and unlimited, nontoxic renewable energy sources, which may be defined as follows:

- Limited energy sources: They are sources, which mostly come from the earth, such as oil, gas, water, coal, wood, plutonium, uranium and other sedimentary based materials or mineral materials.
- Unlimited, nontoxic energy sources: They are mostly known as renewable resources, for instance wind power, solar radiation, wave motion, hydrogen gas from water, biomass and etc (Tsui, 1999).

To use energy more efficiently, strong movements took place to change the patterns of energy consumption, it was found out that energy demands should be moderated. So that it should be adapted in such a way, in which the most output of a certain amount of energy use would be achieved. Equipments using less energy and yielding more power have to be used, while leaving less waste. Finally, energy has to be conserved and cogenerated. Cogenerating means the process that makes some of the waste heat useable, instead of releasing heat to the environment (Tan, 1997).

It seems to be necessary to be aware of this fact, that the building and construction sector globally use 30-40% of the total primary energy (United Nations Environment Programme, 2007). It is believed that the building sector can potentially decrease primary energy usage and also decline the CO₂ emission by utilizing more renewable energy sources. Thereby, to develop these potentials, several strategies can be used, especially in the construction sector, including energy efficiency requirements in building standards (Dodoo, Gustavsson, & Sathre, 2011).

2.2 Sustainability and Renewable Energies

In the contemporary world, apart from definitional differences, sustainability converts to an important challenge for everyone. Most specialists believe that sustainability is maximizing the efficiency of things in order to make it possible for man to benefit it (Scott, 1998). The 'benefit to mankind' is the point of opposition. Each profession defines it in a different way. In addition, the main problem can be considered as the traditional patterns of architecture, which are no longer viable, and alternative models are not yet progressed. The common dilemma is how to manage the interconnections between ecological conditions and ecological balance.

However, when building suitability is discussed, it means that they should respond to the users' needs and it should not be just an environmental strategy (Anink, Boonstra, & Mak, 1996). They should provide more places for people to live in, be more intelligent in balancing their energy flows, have more respect to the nature and what it presents them and have a better understanding of constructions that bear incredible changes during their life span. In this case, the complete and accurate balance between the nature (environment) and human beings is occurring (Özay, 2005). Considering all these, buildings should be constructed as environmentally friendly and have better design (Scott, 1998).

Meanwhile, it should be mentioned, that in general three major technological changes are typically involved in the development of the sustainable energy strategies: Applying efficient improvements in energy production (Lior, 2010), consuming renewable energies instead of fossil fuels (Afgan & Carvalho, 2004), and energy savings by consumers (Blok, 2005). Consequently, plans for implementing

renewable energy sources in large scale must exist among the strategies for integrating renewable sources (Hvelplund, 2006).

Apart from the matter of durability, which is a very limited perspective and point of sustainability, the value of art in this issue, in order to overcome the tendency of societies had always been neglected. Therefore, from the architectural point of view, sustainable buildings are constructed based on three main purposes. The first purpose is the harmony with nature, it tries to develop the entirely selfish motive of survival. The second one is to construct the shelter due to the principles of ecological architecture. Finally, the third proposal wants to determine the luxury of this existence, that has led to appalling track record of environmental abuse (Wines, 2000).

Renewable energies result from two distinct issues. Concerns about preserving energy supplies against unexpected crisis and the time, the issue that fossil fuels will come to an end have led to the renewability, and the focus of this thesis will mainly be on the first part (Beaver, 2005). Maladaptation, the exploitation of the earth's energy sources, which has led to sustainability, may cause next generations to have a poor life in future. During the past three or four decades, a lot of attention has been paid to these two important matters and obviously the influence of international relations and the political decisions in all levels (Frey & Linke, 2002).

It is now believed throughout the world, that energy is an essential and primary factor in economic development and generating wealth. World population, consumption, industrial activities and similar factors have caused intensive problems and risks for the environment during the past two decades. Finding answers to these

problems surely relates to sustainable development and in this case renewable energy sources seem to be one of the possible answers (Kaygusuz & Kaygusuz, 2002).

Although in many countries around the world, renewable energies are considered as a very important supply, less than 10% of primary energy supplies are renewable energies (Emadi & Lotfabadi, 2011) (Fig. 13). If the whole globe is considered, the initial energy supplies are renewable energy sources. In developing countries the most significant ones are hydro energy and fuels are based on wood, solar and wind energy seem to consist a small portion.

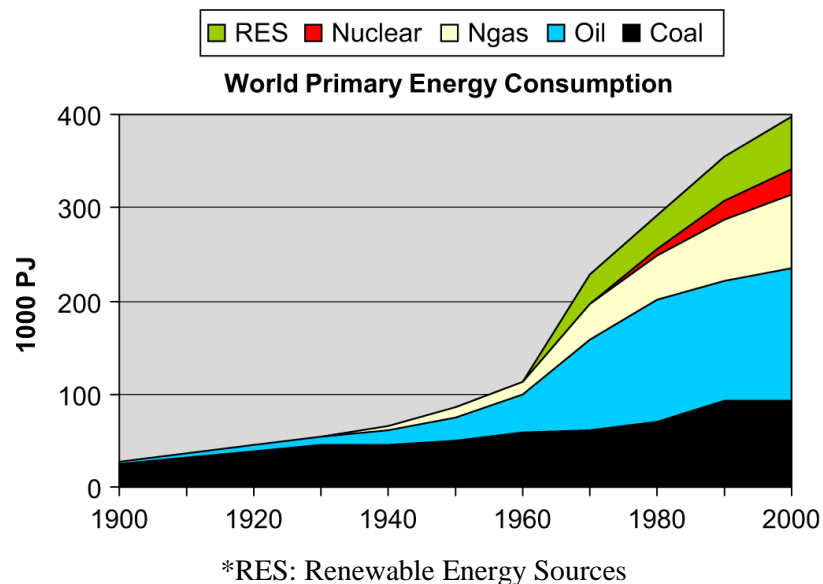

Figure 13. World Primary Energy Supply (IEA, 2000)

Consequential matters, influencing energy systems and clarifying sustainability tendency are the energy efficiency issue and intensities progress towards sustainable development without sacrificing socio-economic growth. This development applies for the efficient energy end use, as a way of declining the amount of consumed energy (Al-Mansour, 2011). Sustainable growth and renewable energy use must go along together. If governments designate subsidies for renewable energies, these type

of energy will grow (Langlois & Vera, 2007), but, as most subsidies do not last long, technologies should become cost-competitive and sustainable commercial markets should be developed (Lew et al, 2001).

Using renewable energy sources surely reduce environmental damages and lead to sustainability. The rate of these kinds of energy consumption is nearly 8%. Those renewable sources help to decrease the global warming or to create a sustainable waste (Dincer, 2000). Nevertheless, each kind of renewable energy sources imposes some kind of damages to the environment. However, in comparison to the current conventional systems, the use of this new source of energy is much cleaner and sustainable (Dincer & Rosen, 2005).

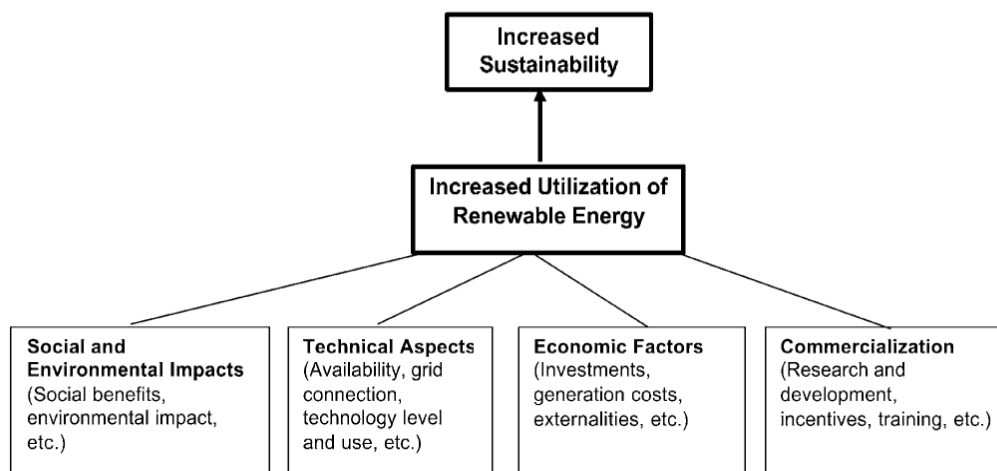

Figure 14. Illustration about the Major Considerations (involved in the development of renewable energy technologies for sustainable development) (Hui, 1997)

2.2.1 Renewable Energy

Certainly, one of the most critical threats to the planet ultimate security is based on the increasing use of sedimentary energy sources. Supply and demand are the two main categories of energy regime, which are the present technological ways to combat against this danger. Consuming renewable sources is the main aim in the

‘supply’ section. It should mainly limit the curbing demand of building and transportation.

As an introduction, if the constructions are considered step by step, it becomes clear that there are many privileges in using renewable energies, not only as offering a snapshot of the energy future, which will greatly influence our whole lives. Furthermore, they will influence the way to construct buildings in the future. Many of the technologies are appropriate as so called ‘embedded’ systems, that are systems, which may be independent of the grid and can be incorporated as stand alone generators within buildings (Smith, 1988).

Nowadays, energy is produced in three different ways throughout the world: Crude fossil fuel such as oil, coal and wood, which has extensively been used, nuclear power, which is accessible to all countries, however, it is only in control of developed countries (Bhat, Prakash, & Varun, 2009).

Renewable energy is essential for development and is easy to use everywhere in the world. It causes less pollution than fossil fuels (Goldemberg & Coelho, 2004). It is available and abundant in nature. The demand for this kind of energy is about 8% of the world energy demand (Dincer, 2000). Recent developments in technology and suitable policies together with the use of renewable energies such as wind energy, solar radiation, geothermal, biomass, as well as the more traditional sources such as hydro power can lead the renewable sources to having a share of 50% of the entire energy demand by mid 21st century (Akella, Saini, & Sharma, 2009).

Renewable energies can be found everywhere and can be harvested and kept for future use in the same area, where they have been generated. Meanwhile, producing this energy does not need a long energy supply chain, this causes self-sufficiency for countries, which itself will lead to less dependency to fossil fuel resources and will cause more economic, social and cultural freedom (Hegger et al, 2008).

According to what was explained above, it can be concluded that nuclear power is associated with some problems such as its waste disposal and accidental catastrophes caused by different natural and human factors and releasing heat into the atmosphere through its cooling system, while fossil fuel has a lot of disadvantages like damaging the environment (Bilgen et al, 2004).

Renewable technologies except biomass do not involve in the burning process, so that atmospheric pollutants such as carbon dioxide, nitrous oxides, sulfur oxides, as well as significant waste byproducts such as ash are not produced. Considering the health problems of these waste products, renewable energy sources are far more better than non-renewable technologies (Frey & Linke, 2002). Renewable energies provide a range of wide choice in energy supply markets, they create new local employment opportunities and enhance the security of supply (Goldemberg & Coelho, 2004).

2.2.2 Renewable Energy Systems

Energy system plays a main part in the society, economy, and the environment and the way they step toward development (WCED, 1987). Both the conversion and the supply side of the contemporary energy system must change. A scenario suggested

by IIASA-WEC ⁵, energy per GDP (the global energy intensity) is supposed to reduce by 0.8 to 1.5 percent a year until 2100 (WEA, 2000). Another energy plan suggested by (Azar, 2003), the quantity of energy efficiency - megawatts - corresponds the entire supply of energy year 2100, which is equal to 0.7 percent energy efficiency increase per year during the 21st century (Holmberg & Nassen, 2005).

Learning from the past: In ancient times, Romans and Greeks knew about the solar energy and were able to benefit from their knowledge. When the cost of wood increased and its availability was rare, they used the sun as an energy source, which suited local conditions, eventually this kind of architecture, based on solar energy, was applied in Japan, China, and New Mexico. 2300 years ago Dositheius⁶ made parabolic mirrors and Diocles⁷ set out their geometric proof. In 1912–1913, Shuman⁸ placed parabolic reflectors outside of Cairo, in the desert and was ambitious enough to cover 20,250 square miles of parabolic reflectors to obtain the same amount of fuel exploited in 1909. But, after the First World War, because of the enthusiasm towards oil and the death of the supporters of the project, things changed. In the late 19th and early 20th a group of experts stated that in order to avoid catastrophes, it was vital to harness sun's energy (Jefferson, 2008).

Furthermore, the main cause of eventual failure was that in those days they could

⁵ IIASA-WEC: International Institute for Applied Systems Analysis - World Energy Council

⁶He was a Greek mathematician, physicist, engineer, inventor, and astronomer (287-212BC). Although few details of his life are known, he is regarded as one of the leading scientists in classical antiquity (Heath, 1980).

⁷He was a Greek mathematician and geometer (240 BC -180 BC). Diocles is thought to be the first person to prove the focal property of the parabola (Heath, 1980).

⁸Frank Shuman: (1862-1918) was an American inventor, engineer and solar energy pioneer noted for his work on solar engines, especially those that used solar energy to heat water that would produce steam.

find no alternatives for these fuels. Some experts believe that if we harness the sun's energy in large scale, we won't face similar problems. However, now we are able to apply both centralized and decentralized methods, which have never been possible before (Jefferson, 2008).

2.2.3 Renewable Energy Technologies

As threats like pollutants and global warming were known, many countries tried to think of substitute energy sources such as solar energy or other renewable sources to be the pioneers in benefiting of these sources.

In early 1970s oil crisis appeared and caused some developments in the field of renewable energies. During this period, factors such as easy access to renewable energies, the high cost of oil and also the cost effectiveness assessments and conversion systems based on renewable energy technologies attracted the most attention. Moreover, recently, it has been found out that renewable energy sources and systems can have a useful impact on some essential environmental, technical, political and economic world issues (Dincer, 1999).

The most critical part of the interaction between architecture and technology is the way they redefined each other. 'High-tech' is defined as an introduction of a rationalized industrial procedure into construction with flexible, expendable and some other characteristics. This sensibility now embraces wider concerns, including place-making social reflexiveness, energy consume, urbanism and ecological awareness, 'Eco-Tech' opposed to 'High-tech'. Instead of being unthinkingly glorified, technology benefits selective exploitation methods to achieve particular ends. Examples of this might include a structural system and engineered to resemble a giant organic ribcage or a translucent cladding panel that has a high level of

insulation or an environmental control system, that can forecast the demand of construction users and respond accordingly (Slessor, 2001).

Through converting natural phenomena into useful energy forms, renewable energy technologies generate marketable energies. The potential energy of sunlight and different energy forms, which are hidden in wind, photons, heating effects, plant growth, tidal force, the heat of the earth's core and falling water, are used by these new technologies to gain energy. As fossil fuels are generally diffuse and not fully accessible, the increased difficulties are solvable (Dincer, 1999). The researches and the developments in renewable energy resources and technologies have increasingly been done during the past two decades to solve the difficulties. Nowadays, renewable energy sources are produced more easily, cheaper and have more reliability and applicability. But, further developments are necessary in this field. The next chapter tries to propose a new way of benefiting sustainable systems.

2.2.4 Renewable Energy Alternatives

For 2050, it has been assumed that post fossil fuel era will be started. This is absolutely what can only be done in case of being a widespread avow to switching to renewable energy sources. This in return will lead to reducing emissions up to 3 billion tons of atmospheric carbon annually as prescribed by the IPCC (IPCC, 2013).

It is conveyed, that many of today's technologies are still in the developing phase and other fields require further research, however, the current era, compels humans to develop new ideas and seek for innovative concepts. Therefore, the idea of developing and designing future buildings is actively supported by a number of architects, engineers, and civil engineers (Daniels, 1997). There are so many renewable energy alternatives, but as it was mentioned in the previous chapter, under

the ‘Study Limitation’, just solar energy, which seems to be more practical in high-rise buildings, will be mentioned.

2.2.4.1 Solar Energy

Solar radiations can be considered as the primary source of renewable energy. Although it can take part as a direct energy source, it impacts the earth's climate. Energy opportunities are developed from waves, tides and wind, which are also a host of biological sources. This kind of energy can specifically be used in building sector as an energy source. However, this source of energy is considered as two parts:

- **Passive Solar Energy:** For many decades, passive solar energy gain has been used as environmental factors. Anyway, the more the global warming debate has been put forward, the more pressure has been put into designing buildings, which causes the maximum use of free solar gains for heating, cooling and lighting (Smith, 1988). As the energy, released from fossil fuel, can be substituted with passive solar energy, it could lead to the reduction of CO₂ emission.
- **Active Solar Energy:** This item focuses on obtaining usable heat from the solar radiation. For instance, in case of temperate climates the most suitable application of solar radiation is using solar radiation to supplement a conventional heating system or to generate power (Smith, 1988).

To take the advantage of solar design, the most basic response as mentioned before is the passive design. Thus, in this kind of solar design, constructions are considered to fully taking the advantage of solar gain without any intermediate operations. However, there are some conditions, which must be determined in order to access to

solar radiations. For example:

- The sun's position associated with building facades principles (solar altitude and azimuth),
- Slope of the site and its orientation,
- Obstructions, which are existing on the site,
- Overshadowing potential of outside obstructions elements.

One of the solar access evaluation methods is using sun chart. The most common one is the stereographic sun chart (Fig. 15). A series of radiating lines and concentric circles allow the position of nearby obstructions to insolation, for instances other constructions that will be plotted next. On the same chart, a series of sun path trajectories are also drawn (usually one arc for the 21st day of each month); also marked are the times of the day. The intersection of the obstructions' outlines and the solar trajectories indicate times of transition between sunlight and shade. Normally a different chart is constructed for use at different latitudes (Smith, 1988).

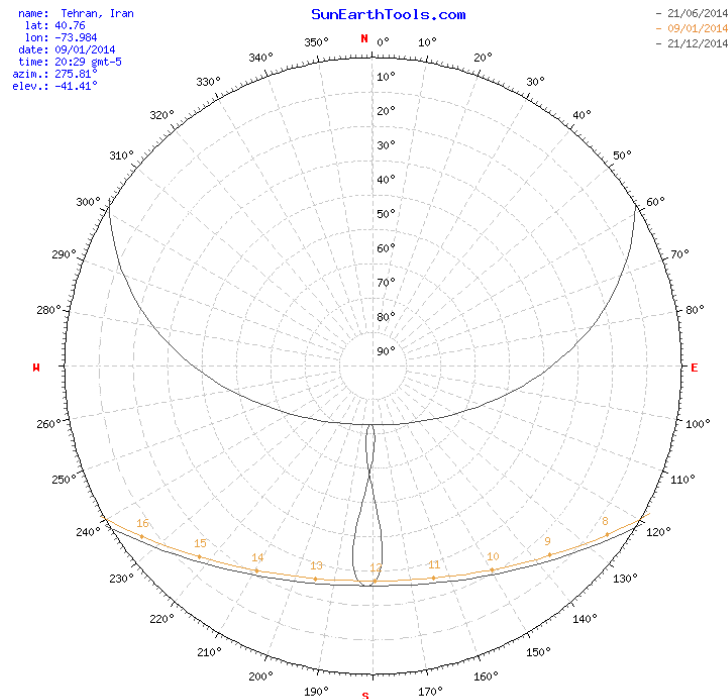

Figure 15. Stereographic Sun Chart for Tehran as an example (URL3, 2013).

Furthermore, passive solar design configurations itself can be separated into five sections (Chiras, 2002):

2.2.4.1.1 Passive Solar Energy

2.2.4.1.1.1 Direct Solar Gain

Direct gain concentrates on controlling the amount of direct solar radiation reaching the living space. This direct solar gain is a critical part of the passive solar house designation as it imparts to a direct gain (Doerr, 2012). Thus, it is a kind of design technique that mainly concentrates on the sun-facing facade. Solar radiations are directly admitted into the space concerned. The main design attributes are as follows:

- Opening for solar radiation should be placed on the solar side. The angle is about $\pm 20^\circ$ of south in the Northern Hemisphere (Doerr, 2012).
- West side facing windows might increase the risk of summer overheating.
- It is better to use double or triple glazed windows with low emissivity glass (so called low-E).

- In design, the most occupied living spaces should be considered on the solar side.
- In order to absorb the heat and set thermal inertia that decrease the temperature fluctuations inside the building, the floor should be constructed from high thermal masses.

2.2.4.1.1.2 Indirect Solar Gain

In this case, a heat absorbing element is added among with the incident solar radiation and space to be heated. Therefore, the heat transfer is in an indirect form. This is often a wall, which is placed behind glazing facing towards the sun. This thermal storage wall controls the flow of heat into the construction. Thus, the most important factors contributing to the design function are as follows:

- The wall heat flow can be modified by its thickness and materials. For instance, for the residential spaces, this amount is between 20-30cm in order to make some delay for this heat transaction and its thickness depends on the occupancy periods.
- In order to prevent heat loss, glazing is used on the outdoor space. It also helps to retain the solar gain by taking advantage of the greenhouse effect.
- Approximately 15-20% of the floor area, which emits heat, should be dedicated to the thermal storage area.
- To derive more instantaneous heat benefit, air can be circulated from the construction through the air gap among glazing and wall, and back into the room. In this adjusted and modified form, this element is commonly referred as a trombe wall (Fig. 16). Heat reflecting blinds should be inserted between the thermal wall and the glazing to limit heat build-up in summer (Smith, 1988).

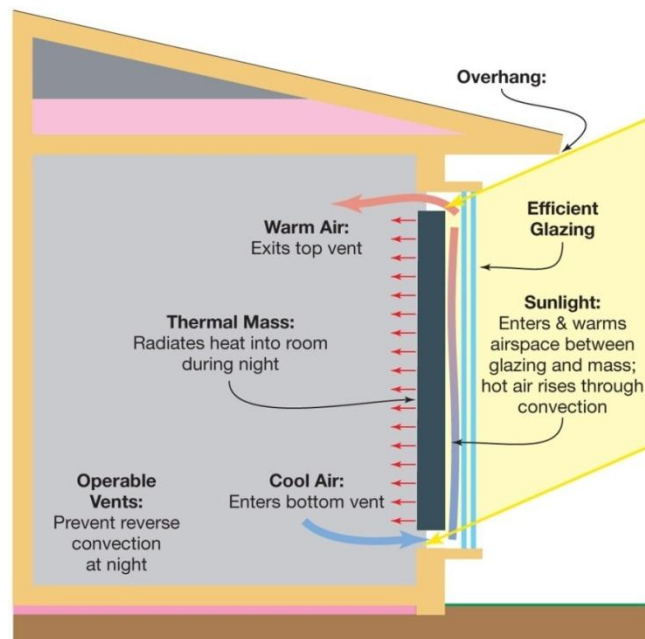

Figure 16. Passive Energy Gain by Solar-Trombe Wall (URL4, 2013)

2.2.4.1.1.3 Isolated Solar Gain

This means benefiting solar energy in living areas through using a fluid like water or air by forced or natural convection. Heat can be gained through solarium, sunspace or solar closet (Zero Energy Design, 2010). Generally, this item can be considered as an extension space, which is added to the living area. It can be used as a solar heat store, a preheated for ventilation or also as an adjunct greenhouse for plants (Fig. 17). As conservatories are often heated, they are a net contributor to global warming, sunspace should be completely insulated in order to prevent the building from getting cold in winter and being too hot in summer.

20-30% of the area of the room to which the glazing is attached should be covered with it. In ideal conditions the amount of heat absorbed in summer should be stored to be used in winter and finally there should be controlled spaces between the building and the conservatory for the air to flow (Smith, 1988). In order to benefit the local natural energy reserves appropriately, apart from global radiation, the

temperature, humidity and wind, specific climate data corresponding to the geographical location are the most considerable factors.

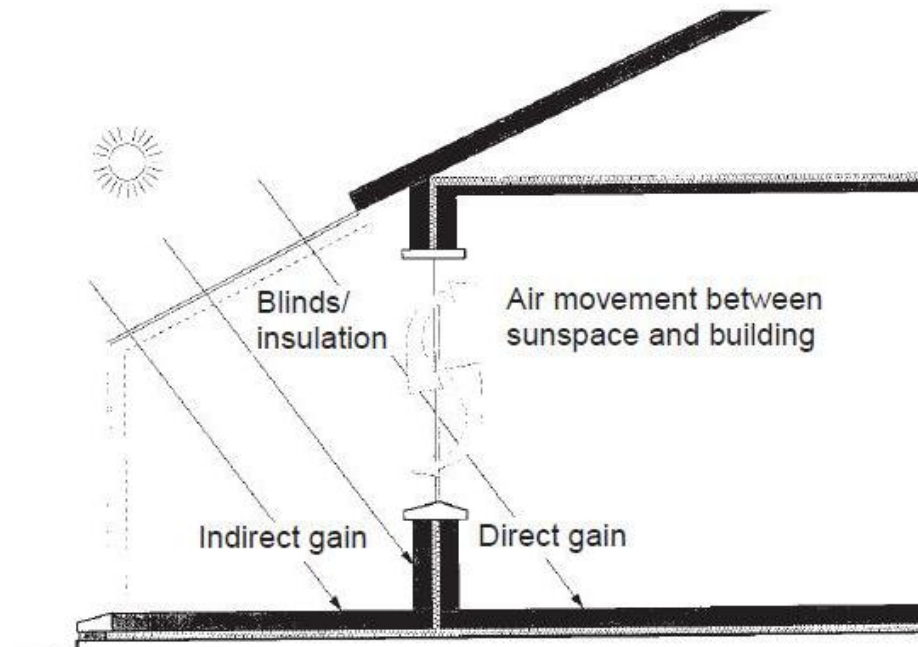

Figure 17. Attached Sunspace (Smith, 1988)

2.2.4.1.1.4 Thermal Storage Mass

The solar radiations cannot be benefited all day, so that it has to be applied for heat storage, or thermal mass to keep the buildings warm. This is designed for only one or few days, which is possible through indirect solar energy gain, such as; trombe wall, a cistern, water wall or roof pond, a ventilated concrete floor (Radically Sustainable Buildings, 2013).

2.2.4.1.1.5 Passive Cooling

The efforts done to minimize energy consumption and improve indoor thermal comfort, which mostly focus on heat dissipation and heat gain control in buildings are referred to as passive cooling. This is possible either by preventing heat from entering the interior (heat gain prevention) or by removing heat from the building (natural cooling). Natural cooling utilizes on-site energy, available from the natural

environment, combined with the architectural design of building components such as building envelope, rather than mechanical systems to dissipate heat (Leo Samuel, Maiya, & Shiva Nagendra, 2013).

In order to take maximum advantages of the local natural energy sources, specific climate data, which corresponds to the geographical location is required. Furthermore, the global radiation, the temperature, wind and humidity are the most significant factors.

2.2.4.1.2 Active Solar Energy

2.2.4.1.2.1 Photovoltaic Collectors

Solar electric modules being made up of a collection of semiconductor cells create a flow of electrons called photovoltaic (PV) collectors to ease electron movement. Most of them are made from polycrystalline silicon cells that are doped with boron and phosphorus (Strong, 1987). Silicon-based photovoltaic modules can be up to 20% efficient because of progressive development and research.

Thin film photovoltaic modules are available on the market these days. A very thin layer of amorphous silicon (Strong, 1987) or cadmium telluride is used in these modules (Photovoltaics Technical Information Guide, 1985). For use in non-traditional applications thin films can be used on a flexible layer or they may be placed between two glass covers and made into a proper module. While thin films cost cheaper and are easier to produce, they are less efficient, between 5% to 13%.As they are flexible, they may be used in building products like curtains and shades.

Gallium arsenide photovoltaic cells have better temperature performance and efficiency than silicon cells. Because of their temperature performance and in order

to increase electrical output these cells can be applied in conjunction with concentrating lenses. Thin film cells have reached 17% efficiency and single crystalline cells have reached efficiency of 25%, which is much more than the capabilities of silicon. Gallium arsenide cells are costly to produce, they are not common in residential photovoltaic modules (Palz & Starr, 1983).

Several types of advanced photovoltaic cells using chemical compounds are being explored. Copper sulfide cells offer the possibility of cheaper cells with better solar absorption, but are hampered by lower efficiency. Copper indium selenide cells are another promising area of research. Specifically copper-indium-diselenide is the most promising since it is the semiconductor with the best solar absorption available. This results in a high current output but a very low open-circuit voltage. The answer to this problem has been alloying the material with gallium to increase the band gap which in turn increases open circuit voltage (Photovoltaics Technical Information Guide, 1985).

Arrays are a collection of photovoltaic modules wired together. Usually strings of several modules in series are wired in parallel. Frequently a combiner box is used to combine the parallel strings into one set of wires, which helps to reduce clutter and makes running wires easier. Since photovoltaics produce direct current electricity, an inverter is needed to supply alternating current loads. Inverters can be either standalone or grid-tied. In a standalone system, energy storage, usually in the form of a battery bank, is required (Strong, 1987).

This type of system also requires charge controllers, takes up a lot of space and has an inherent maximum capacity for storage. A grid-tied system does not require much

equipment besides the inverter since the electrical grid acts as an “infinite” storage source. Grid-tied inverters interact with the grid and typically disconnect themselves when there is a grid outage. While inconvenient for the homeowner, this is done for the safety of crews who may be working on the grid (Strong, 1987). In the 2009 Solar Decathlon, only grid-tied systems were allowed.

Photovoltaic mounting structures are found in two different types: tracking and static. In most houses static type is applied and the roof is used as an anchor. Since the sun's position in the sky changes day by day, they have to be mounted at an angle having the most output. In most cases static arrays are mounted very close to the roof's surface, which causes air to flow behind the modules less, which in turn decreases efficiency and increases temperature. In order to increase cooling potential and efficiency, we can mount arrays off the roof and keep them perpendicular to the sun. One more point is that the tracking arrays are more costly than the other type (Strong, 1987).

2.3 High-Rise Buildings

Regarding ecological design, large scale buildings require great attention. This is because of their great need for resource consuming their potential of environmental polluting and economic relations (Dupre, 2008). Cities will likely decide on a global policy for a sustainable future. If the migration projects from rural areas to urban districts come true, a possible solution is the construction of high-rise buildings (Chart. 1). Obviously the effective use of valuable sites is growing cities to build upwards in order to accommodate the swelling urban population (Yeang, 1999).

Chart 1. Percentage of the Population in an Urban Area, 1950-75, with Projections to 2000-25

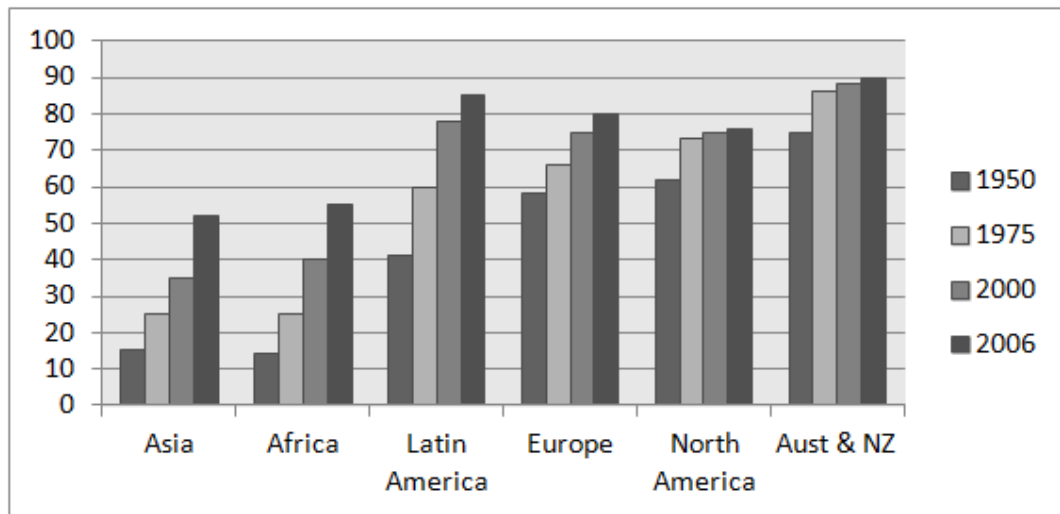

(Scott, 1998)

Essentially, a high-rise building is a construction with a small footprint and also a small roof area in comparison with its very tall surface areas (Eisele & Kloft, 2003). Thus, what makes it different from other ordinary buildings— whether low rise or medium rise buildings— is that it requires special design and engineering systems due to its high and its special potentials. In this case, Mario Campi believed that:

“The skyscraper is clearly identifiable not only by virtue of its historical development and the specific approach to architecture it embodies, but also because it has an identity easily readable as an architectural type. By this I mean that the skyscraper is a manifest product of a historical development, a creation of the altered nature of our cities, and that it has often left its mark as an adequate response to the urban evolution of specific urban situations and the modern city in general; it has thus achieved legitimacy as a contemporary expression of modernity” (Campi, 2000).

2.3.1 The Importance of High-Rise Buildings

Some people doubt about the fact, that skyscrapers and other gigantic buildings may be designed in such a way that can be ecologically responsible. They think high-rise buildings just impose themselves to the environment and merely consume energies. An ecological skyscraper is may be a contradiction (Yeang, 1996). At the same time, they may also consider the high-rise building as a building type, which is much smaller and uses less energy and declare it as the latter for the future. Their argument is that by virtue of their gigantism, high-rise buildings consume enormous amounts of energy and materials and make similarly extensive discharges into the natural surroundings, and are thus inherently un-green (Yeang, 1999).

It is believed that precious building materials and components of high-rise buildings, because of their huge size, have significantly the capacity of being recycled, but some views neglect to consider it thoroughly. As mentioned above, there are also a number of positive justifications for the high-rise building's existence. The main reason is the planning awareness, which introduces the skyscraper as an effective green alternative to well-known low-rise, decentralized suburban structure (Yeang, 2011).

Furthermore, the decentralized form of built environment requires higher consumption of non-renewable energy resources, particularly for transportation. It is quite clear that a decentralized planning layout of structures leads to far more travels between buildings (Yeang, 1995). Recent studies have revealed that if less energy consumption by automobiles per person is required, the urban population should be intensified. Indeed, it appears as a geometrical relationship between declined energy use through transportation to the increase in building density (Fig. 18) (Yeang,

1999).

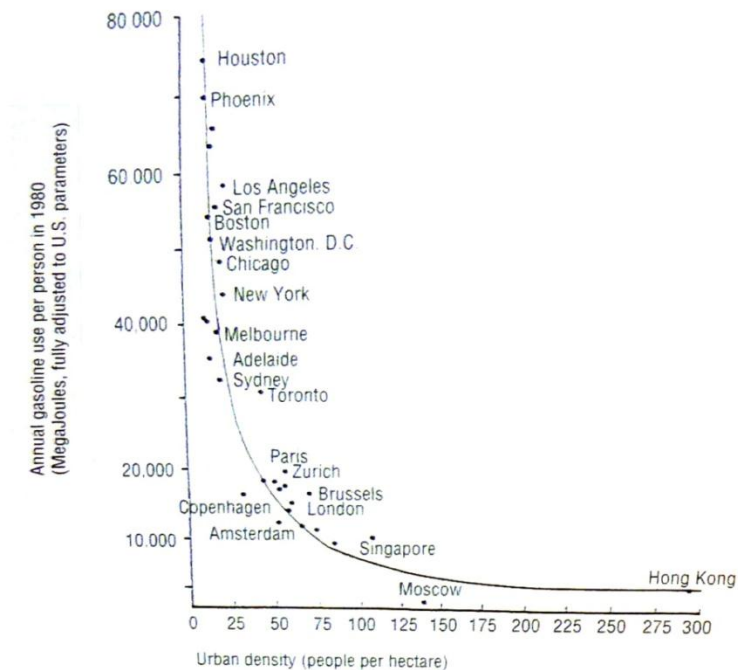

Figure 18: Gasoline Consumption and Urban Densities (1980) (Yeang, 1999)

If higher density of living and working spaces is reached, a reduction of urban travels, car ownerships, demand for parking spaces and an increase in public transport utilization will be expected (Steel, 1997). The next achievement must be a more economical use of land through a higher density or intensity of land use in new planning schemes, together with well planned infill developments. This will help to reduce infrastructure costs and reduce the exploitation of further areas of available land for development (Yeang, 1995).

Higher density with residential high-rise development has another social benefit, which is creating pedestrian life in the ground-plane. This has more benefits including the reduction of energy, land and pollution demands of all forms of transportation (Van der Ryn & Calthorpe, 1991). High density development also

declines per unit infrastructure costs and therefore, improves the affordability. It minimizes car trips, due to walking and bicycling, which become pleasurable and convenient, and ultimately the outcome is increased public transport efficiency (Yeang, 1994).

By concentrating the construction of buildings on a small portion of land, the preservation of the land devoted to agriculture and the unbuilt vegetated land will be achieved. If concentration and intensification of the buildings on different separate parts will be reached. The ambient temperature of the locality is lower, and consequently reduce the phenomenon of overall 'heat island' (Warren, 1998). Therefore, in brief, it can be claimed that designing ecological large scale building, especially high-rise building, which are high energy and material intensive, urban building types is a matter that deserves urgent attention, because of the high-rise's ubiquitousness all around the world.

Chapter 3

THE EVALUATION OF HIGH-RISE BUILDINGS IN TERMS OF SOLAR ENERGY USE

Having thought over the global warming challenge and opportunities to present non-fossil energy, it is time to consider, how the demand of the energy consumption can respond to that challenge. The main target and philosophy of this chapter is to integrate the relationship between architecture and the natural environment, especially the effect of solar energy on high-rise buildings. In designing the bioclimatic skyscrapers, the effect of vertical landscaping idea, the eco-infrastructure concept and so on will be discussed. Therefore, the challenge is to design the built environments as man-made ecosystems, which are seamlessly and benignly bio-integrated with the natural environment.

In this case, the way in which a building is situated collaborates to some external factors and causes, such as other construction positions, natural environmental features and so on, which can have a major determinant of its energy consumption and also its efficiency. Therefore, this chapter is going to evaluate and analyze the effects of solar energy in designing energy efficient skyscrapers and high-rise buildings. Thus, the author tries to analyze and explain some important factors and solar consideration to have more sustainable and energy efficient buildings.

3.1 Method of the Study

As it was completely discussed in the first chapter, this thesis is mainly based on the descriptive research method. However, the information is supported by field work,

literature studying and analyzing the case studies. Therefore, in order to have the evaluation of the effect of benefiting solar energy in high-rise buildings, three high-rise buildings with nearly the same structures in the same climate zones are selected. Accordingly, to have a better comparison among case studies, all these three cases, with different levels of energy efficiency are selected from the temperate climate zone. This is done considering the fact that the performance of the solar technologies can be better compared with the same climatic conditions.

The first case study is the Tehran International Tower, which is located in Iran and was selected as a conventional case study that is not organized to benefit whether from passive solar strategies or active solar technologies. The second case is Frankfurt Commerzbank. It is situated in Germany and as a first ecological high-rise building, totally planned to use passive solar strategies. Finally, the third one, the Pinnacle Tower, is in London. This case is one of the Ken Yeang's projects, which planned to benefit from both passive and active solar strategies and technologies. Thereby, this chapter tries to analyze each significant aspect of the solar passive strategies and solar active technologies in each case study and compare them together.

3.2 Climate Zones

Different parts of the world have different climates. Climate is the long time pattern of weather in a particular area. In other words, this is a long term assessment of the average temperature variation patterns, such as humidity, wind, air pressure, precipitation, and other meteorological variables in a certain territory. Furthermore, there are many different systems, which categorize climate in different types. However, in this study climate is categorized into four major zones (Fig. 19), which

are hot and humid, hot and arid, temperate and cool climate zones. As it was mentioned, all cases are selected from the temperate climate zone, which can be analyzed in terms of architectural responses to significant climatic conditions.

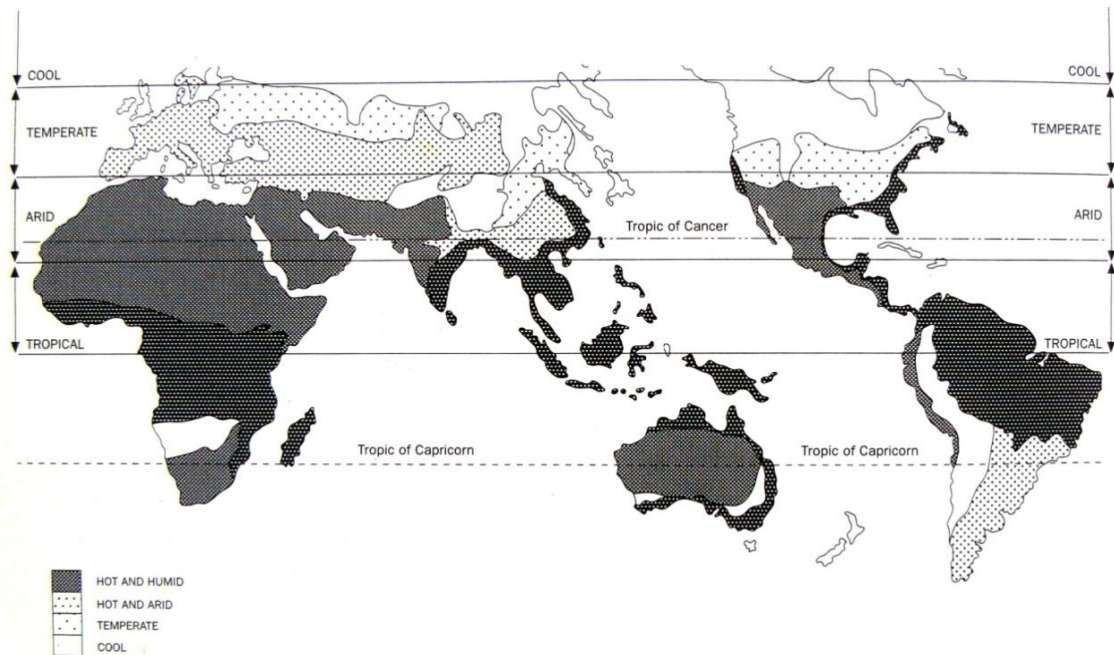

Figure 19. The Four Major Climate Zones (Hamzah & Yeang, 2000)

By considering the naturally occurring climatic regulators and environmental factors, reduction of dependence degree on artificial forms of cooling, heating and ventilation in different climates is possible. A study of these matters can create a picture of the local climate, which leads architects to the fact that site conditions might be positively exploited with the natural environment.

3.3 Case studies

3.3.1 Tehran International Tower in Tehran, Iran

The first case study is the ‘Tehran International Tower’, which is located in Tehran, the capital city of Iran. It is a type of block, which is designed and constructed by the A.S.P Corporation. This project construction process was finished in 2007 and

currently is the highest residential tower in Iran. According to the new municipal rules and building codes in Iran, somehow, it has attempted to respect the environment. It is a 56 storey residential building and its height is about 164m (Figures. 20&21).

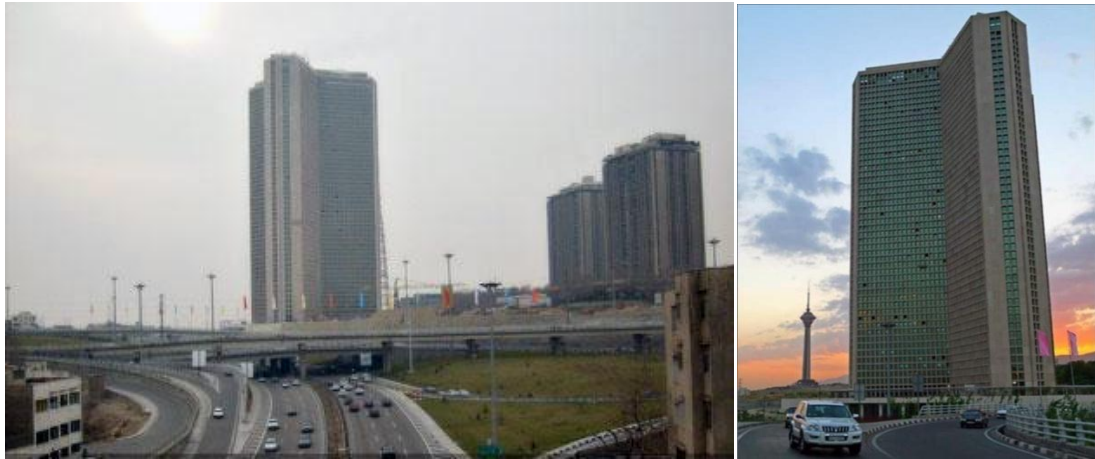

Figures 20 & 21. East and South Facade of the Tehran International Tower
(Author, 2012)

The infrastructure of the tower is approximately 220,000m². The project structure consists of three wings with angle of 120° (Fig. 22), each consisting of three main reinforced concrete load-bearing wall's core. Also, the reinforced concrete slabs are the main material of the roof structure as well. Furthermore, in order to reduce energy consumption, the internal walls are covered with thermal and sound insulation. It is located in Amirabad neighborhood, close to the junction of Hakim and Sheikh Bahae highways.⁹

⁹ The A.S.P Corporation technical management, personal communication, July, 2012



Figure 22: The Tehran International Tower Site Plan (The A.S.P Corporation, 2012)

Furthermore, this high-rise building was the first construction in such a huge scale, which was built with Glass Fiber Reinforced Concrete (GFRC) in Iran. Generally, this material has been selected in order to have comparatively good thermal quality, pretty quick installation, less waste material, cheap lifecycle and so on. Furthermore, the GFRC panels benefited from Spray Polyurethane Foam Insulation to reduce the building energy demand (Fig. 23).

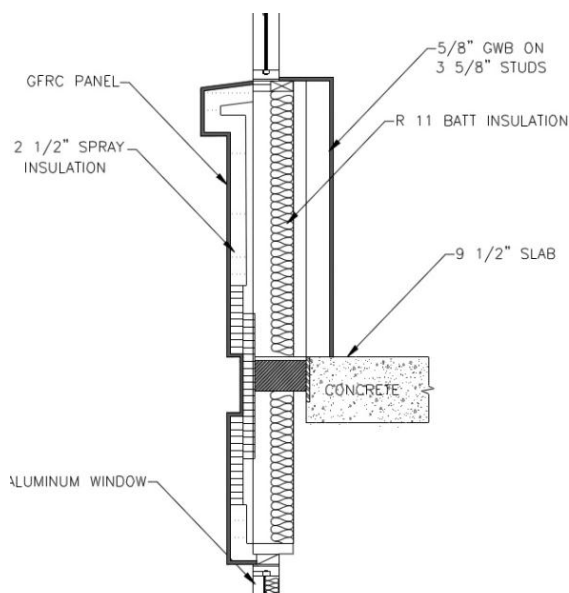
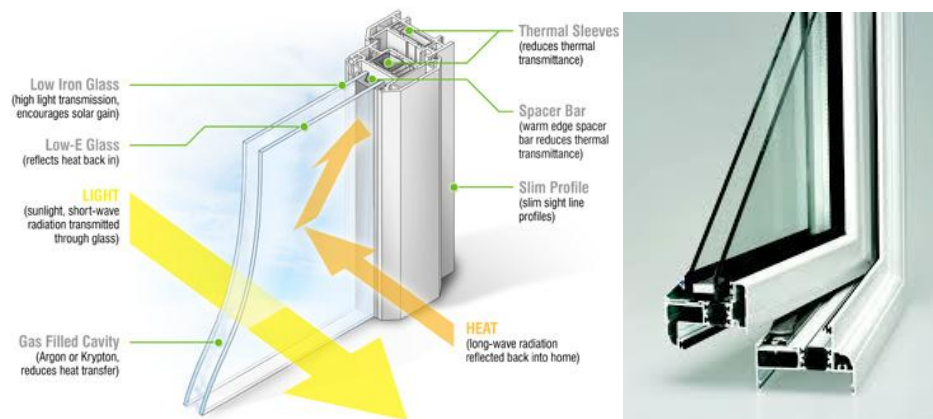

Figure 23. GRFC Wall Section (Burnie, 2008)

This case is also benefiting from double glazed windows. These ‘Insulated Glass Units’ (IGU) are 3mm thick. Accordingly, these sealed units gain their maximum amount of sound and thermal insulating values by employing an Argon gas in 16mm cavity space. When this is combined with the glass pane, the overall IGU thickness will be 22mm for the 3mm glass.¹⁰



Figures 24 & 25. Tehran Tower Double Glazed Window Detail

3.3.2 The Frankfurt Commerzbank in Frankfurt am Mine, Germany

Norman Foster's high-rise buildings are equal to ambitious design. The Frankfurt Commerzbank was a meaningful progress as the first demonstrably ecological tower, which gains natural light and was organized in modules or villages of interior spaces (Figures. 26 & 27). This is a 56 floor building with the height of 259m. The building contains around 80,000m² of office space with a further 45,000m² of other uses. It was one of the initial attempts to be an ecological building with regard to energy efficiency policy and natural ventilation in 1991. One of the main reasons of being green was, that the city policy was in favor to have an eco-high-rise building (Pank, Girardet, & Cox, 2002).

¹⁰ The A.S.P Corporation technical management, personal communication, July, 2013



Figures 26 & 27. The Frankfurt Commerzbank Day and Night Views (URL5, 2007)

Ignoring the necessity of supporting columns in gardens, the skyscraper, in contrast with the formal concrete was built with steel structure. However, the floors were constructed as a combination of steel beams and concrete slabs on metal panels. Apart from thick cores for vertical service movements, one of the fundamental principles of the building is the central void, which runs the full height of the building (Campi, 2000). Related to that void, there is a sequence of gardens that help to improve both ecological aspect and good views for offices. So, the main idea was designing the triangular plan in order to move at all three corners.

However, in each floor, just two corners are offices and the other one is a garden (Fig. 28). But, the point is that gardens didn't stay fixed on one elevation, they are nine, four storey gardens, which rotate all around the plan in such a way that all the offices are always in contact with one garden or another. Furthermore, ignoring the necessity of supporting columns in gardens, the skyscraper, in contrast with the formal concrete was built with steel structure. However, the floors were constructed as a combination of steel beams and concrete slabs on metal panels. This building

has a double facade with adjustable solar shading, which will be discussed more (Fig. 29).

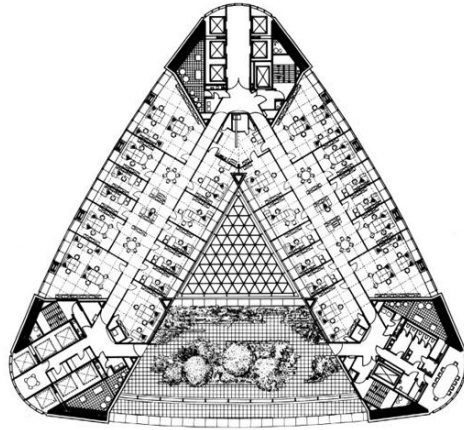

Figure 28. The Frankfurt Commerzbank Typical Office Storeys (Campi, 2000)

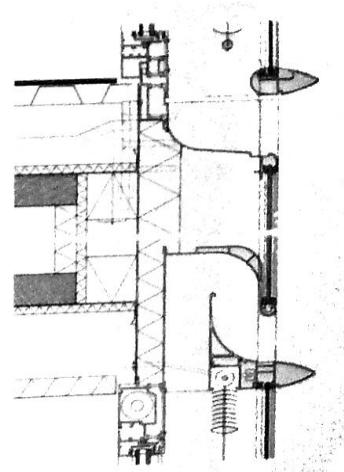
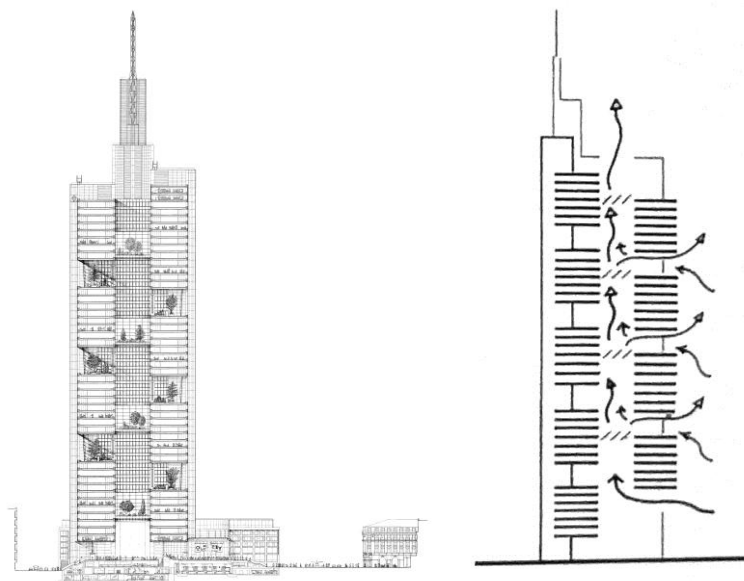

Figure 29. The Frankfurt Facade Detail (Campi, 2000)

These green spaces are part of the building total natural ventilation system. The fresh air comes in through the top of the gardens, then moves up through the central atrium. Furthermore, the cross ventilation from the gardens in every three direction shows the adequate indoor air quality (Figs. 30&31).



Figures 30 & 31. The Frankfurt Commerzbank Ventilation System (Buchanan, 2012)

It is estimated that the natural ventilation system will operate on average for about 60% of the year and the rest 40% of the year will be too cold, too hot, or too windy. With the automatic window system, the ventilation system will be down to 35% in comparison with the conventional fully mechanical air conditioned office high-rise buildings (Scott, 1998). Therefore, very substantial energy saving is achieved.

3.3.3 The Pinnacle Tower in London, United Kingdom

The Pinnacle or the Bishopsgate Tower is one of the latest Ken Yeang's projects, which totally illustrates the characteristics of his green and ecological skyscrapers. It is a kind of skyscraper with the original exterior 'helter skelter'¹¹ design, located at Bishopsgate street, London. It is a mixed-use complex with emphasis on residential use. The project construction had been started in September 2008 by Kohn Pedersen Fox as a head architectural office and CBRE Group, Inc. With a height of approximately 288m, it is estimated to be the second tallest tower after the 'Shard' in the UK and also in the European Union.

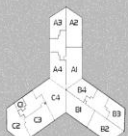
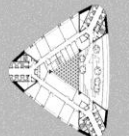
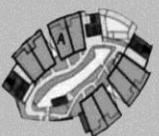

Figure 32. The Pinnacle Tower (Hamzah & Yeang, 2001)

¹¹A helter skelter is a funfair or amusement park ride with a slide built in a spiral around a high tower.

Therefore, in order to summarize the above information the following table could be drawn.

Table 1. Case Studies General Information

The Evaluation of High-Rise Buildings in Terms of Solar Energy Use				
Basic Information		Case Study 1	Case Study 2	Case Study 3
		Tehran International Tower	Frankfurt Commerzbank Tower	Pinnacle Tower
		Normal High-Rise Building	Passive Design High-Rise Building	Active & Passive Design High-Rise Building
	Climate Zone	Temperate	Temperate	Temperate
	Function	mixed-use complex (Residential)	mixed-use complex (Bank)	mixed-use complex (Residential)
	Location	Tehran/ Iran	Frankfurt am Mine/ Germany	London/ UK
	Height	164m	259m	288m
	Area	220,000m ²	125,000m ²	81,400m ²
Plan Shape				

(Drawn by Author, 2013)

3.4 Solar Energy Usage Potential on High-Rise Buildings

3.4.1 Passive Solar Design Strategies

This type of design benefited from sunlight, almost without using active mechanical systems. This strategy uses solar radiations for heating, for instance, water, air, thermal mass, it may also cause air-movement used as heat exchange. Furthermore, the main objective of designing a passive solar construction is to benefit from the local climate. In this case, direct solar gain, indirect solar gain, isolated solar gain, thermal storage mass and passive cooling should be considered as passive solar design techniques in designing high-rise buildings.

3.4.1.1 Direct Solar Gain

This item mostly concentrates on the value of direct solar radiations, which are obtained in the living spaces. This type is an essential part of the passive solar design. A part of the sun's electromagnetic radiation is the sunlight, which is

particularly visible- wavelengths between 390 to 700 nm - infrared and ultraviolet light (Starr, 2005). Generally, whenever the clouds are not blocking the solar radiation, the gained combination of bright light and radiant heat, are called direct solar radiation. Otherwise, when it is blocked by whether clouds or other reflective objects, it is known as diffused light. In this part in order to analyze the effect of direct solar radiation, due to research limitation, the main attempt of the author is to evaluate the effect of the most meaningful factors, such as orientation, ventilation, daylighting and shading devices on case studies.

3.4.1.1.1 The Tehran International Tower/ Iran

Based upon the sun movements, passive solar buildings typically have windows (glazing) on the building's south facade in order to absorb the solar energy to warm the building in winter (passive solar energy gain). The Tehran International Tower as a modern style high-rise building has a huge porosity facade. Furthermore, although the south direction with a little deviation is the best, this skyscraper tries to gain the maximum amount of the south radiation by composing the three wings angle of 120° .

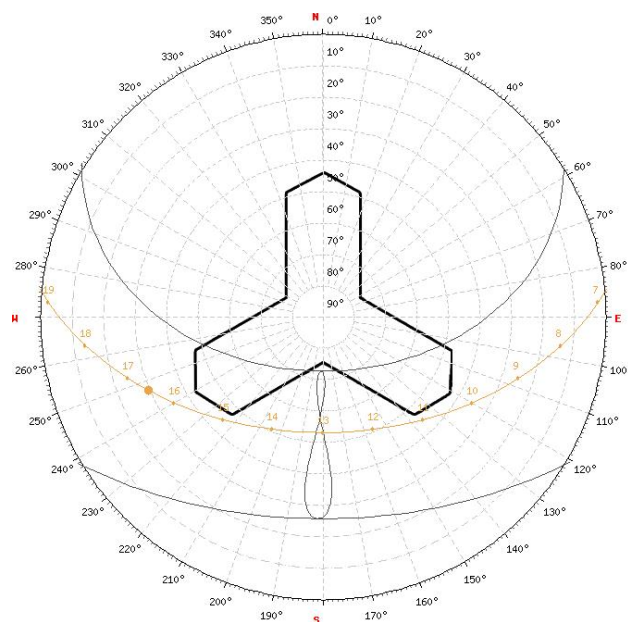

Figure 33. Tehran International Tower Sun Path (URL3, 2013)

In Tehran International Tower project, due to diminishing artificial lighting, reducing energy consumption in heating and cooling and also maximizing the visual comfort, the architectural group employed big size double glazing vertical windows. These windows selectively allow solar radiation and scatter the sun's light at all times of the day and year.

By using rigid shading devices the amount of absorbed heat through the solar radiation can significantly be reduced. Thus, this consideration decreases the overheating of indoor spaces in summer and cooling energy demand. In this case, 'egg crate' shading devices are used. These shading devices are used generally in all directions, so that sun control is not achieved efficiently. Efficiently egg crate is useable only in east-south and west-south directions. Moreover, these devices have a severe effect on the tower appearance and identify the skyscraper elevation and also divide its facade to provide human scale.



Figure 34. Egg Crate Shading Devices (Author, 2012)

Therefore, the effect of using shading devices, calculated with the mentioned formula in the second chapter, is shown in the following table. This amount is also compared with the standard amount, which was calculated for the Tehran climate zone. Additionally, the constructors of this tower believe that by considering the effects of

direct solar gain in the project, entire energy usage of each apartment unit declines as much as approximately one-sixth of an ordinary high-rise building in the same district.¹²

Table 2. Shading Devices Calculation for the Tehran International Tower

The Tehran International Tower Shading Devices Calculation	
Overhang	Constructed Amount
Projection from surface	95cm
Height above window	0
Ext. past righthand side of window	0
Ext. past left hand side of window	0

(Drawn by Author, 2013)

3.4.1.1.2 The Frankfurt Commerzbank Tower, Germany

The building architecture responds to predominant winds and solar orientation, to guarantee optimum ventilation and daylight penetration. The triangular shape of the skyscraper with the South-West orientation about 16°, cause it to benefit from maximum solar radiations and winds in all directions.

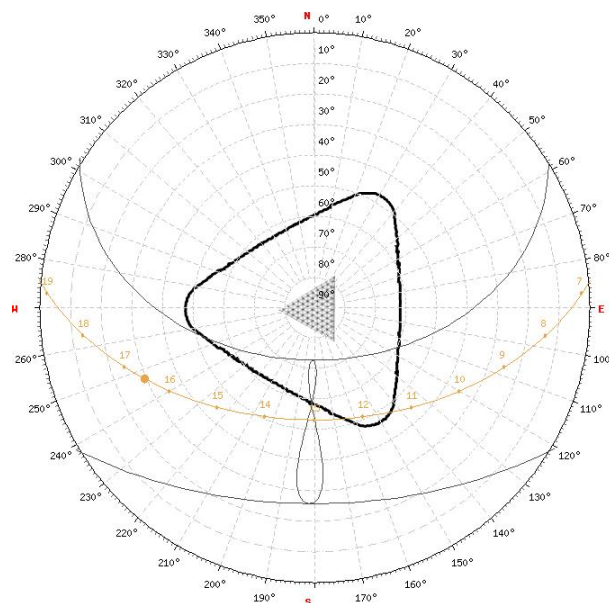

Figure 35. Frankfurt Commerzbank Tower Sun Path (URL3, 2013)

¹²The A.S.P Corporation technical management, personal communication, July, 2013

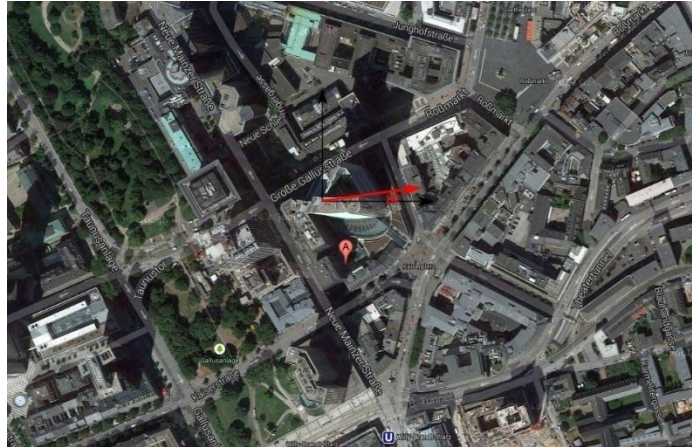

Figure 36. Frankfurt Commerzbank Tower Site Orientation (URL3, 2013)

Winter gardens, which directly gain solar radiations, spiral up around the atrium in order to become the visual and social focus for four-storey office clusters (Figures. 37 & 38). From outdoor views, these types of floating gardens in the sky, induce the sense of lightness and transparency to the tower simultaneously. Furthermore, from a social point of view, the gardens form focal points for village-like clusters of offices, which provide spaces to get rest or greeting with friends during break times.

Finally, they help the central atrium ventilation circulation, which is used as a kind of natural ventilation chimney, by providing fresh air and also light into it. Moreover, to make advantages of natural ventilation and daylighting, each office has operable windows. It should be mentioned that, when the window is open, the ventilation, heating and cooling system will be automatically shut off, which leads to more saving in energy section. Furthermore, it is estimated that the amount of saving in heating and cooling sector in this skyscraper is nearly 20%.



Figures 37 & 38. Frankfurt Commerzbank Tower Gardens (Chan B. , 1997)

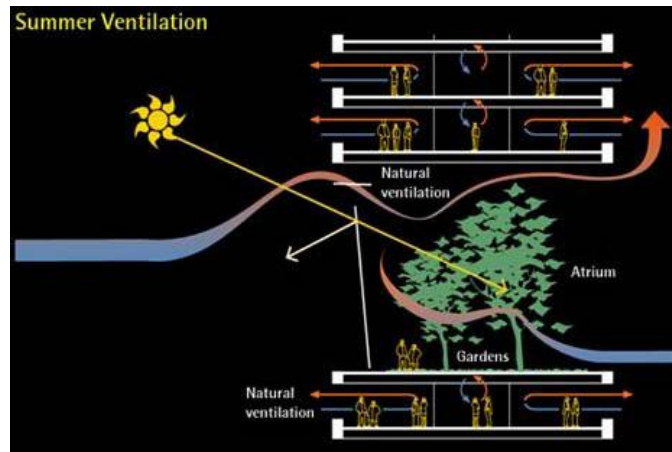

Figure 39. Commerzbank Tower Natural Summer Ventilation System (Chan B. , 1997)

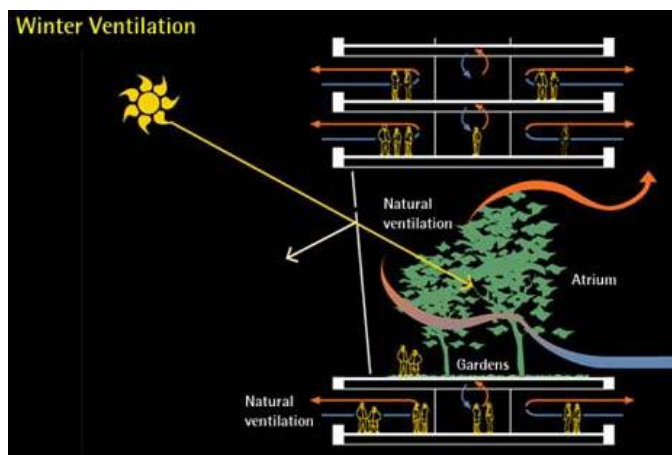

Figure 40. Commerzbank Tower Natural Winter Ventilation System (Chan B. , 1997)

3.4.1.1.3 The Pinnacle Tower, UK

This project is totally found on the Yeang's ecological design agenda by considering some basic principals, such as building orientation and configuration and also using green spaces and landscaping in its conceptual design. So, it is constructed considering the passive low energy response principals. The entire construction form is controlled by the site sunpath and summer and winter windrose status.

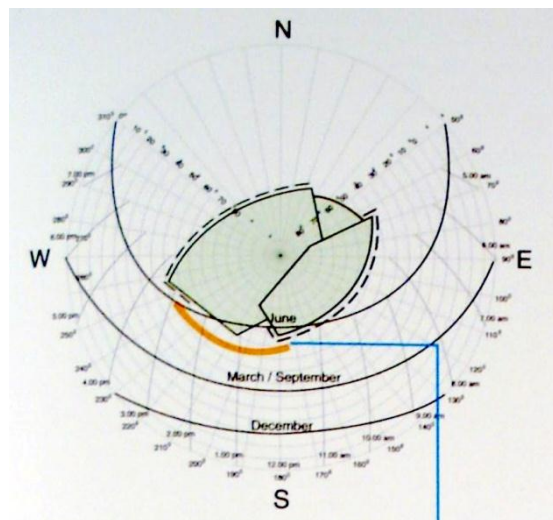

Figure 41. The Pinnacle Tower Sun Path (Hamzah & Yeang, 2001)

In order to obtain solar protection in summer, lift cores are located at the west and northeast facades of the building and in winter southeast units and central landscaped circulation area have a maximum solar gain. As this building is a semi cubic skyscraper form, rotated approximately 30° in a North-East direction in order to ensure optimum ventilation and daylight penetration from the south solar direction in two facade sides (Fig. 42). This is also due to the fact that the prevailing winds in London come from this direction (Fig. 43). Therefore, it can benefit from most solar radiations and winds in all directions. Meanwhile, each facade contains vast transparent windows that can provide better air ventilation and help to achieve maximum daylighting.

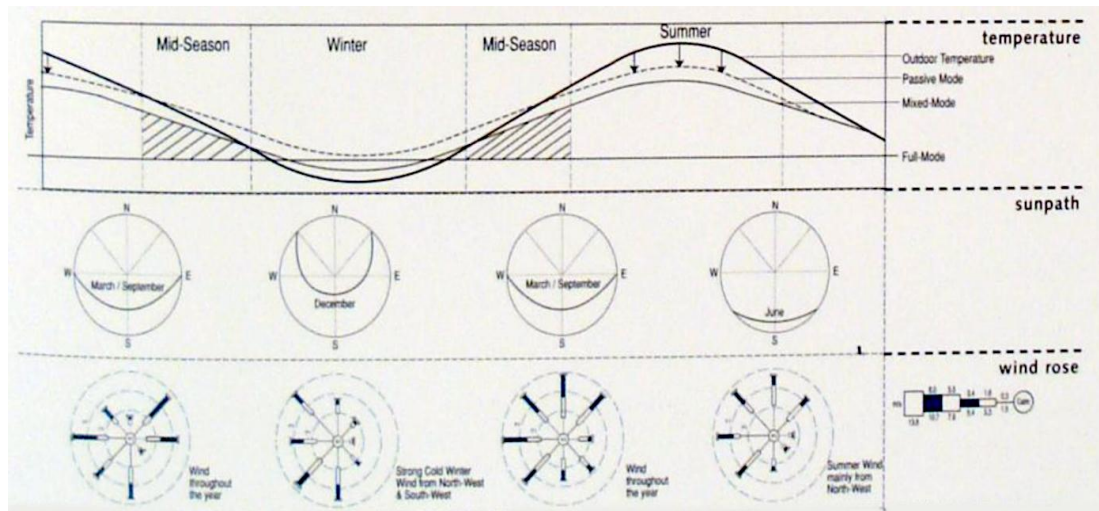

Figure 42. Temperature Differentiation, Sunpath and Wind Rose for the Pinnacle Tower (Hamzah & Yeang, 2001)

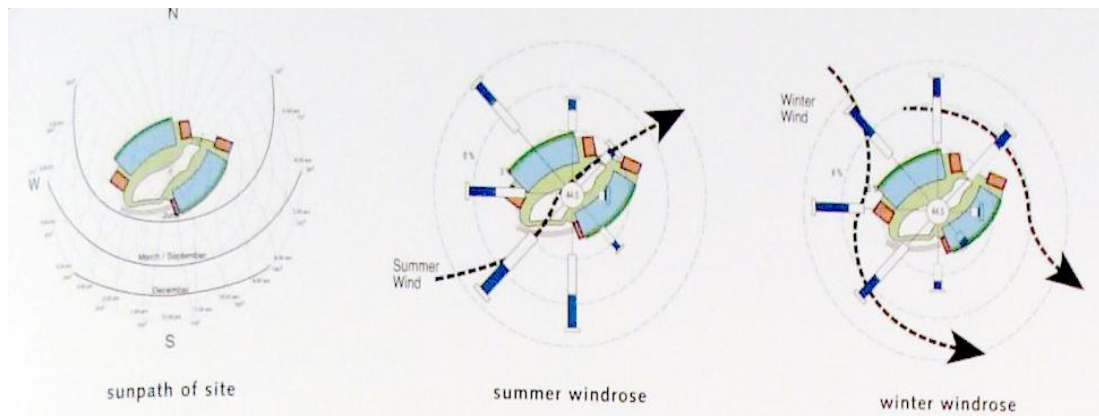

Figure 43. The Pinnacle Tower Sunpath and Wind Roses (Hamzah & Yeang, 2001)

Here, in order to have a better comparison among the case studies with the glance view the following table is drawn.

Table 3. Evaluating Case Studies from the Effect of Direct Solar Gain

		The Evaluation of High-Rise Buildings in Terms of Solar Energy Use			
		Case Study 1	Case Study 2	Case Study 3	
		Tehran International Tower	Frankfurt Commerzbank Tower	Pinnacle Tower	
Direct Solar Gain	Orientation	Standard Angles			
		Actual Angles	Composing the 3 Wings Angle of 120°	South-West Direction	
		Axies Angle		North-East Direction	
	Orientation Consideration		---	Prevailing Wind Direction	
	Shading Devices	Type	Egg Crate Shading Devices	Not Applied	Not Applied
		Standard Size	95 × 95cm	Other Considerations Sky Gardens	Other Considerations Weather Protected Landscape Core
		Actual Size	120 × 120m		
	Daylighting	Consideration	Huge Vertical Windows 1.4m × 3m	Vast Transparent Windows Sky Gardens	Vast Transparent Windows Landscape Core
	Ventilation	Consideration	Operable Windows	Operable Windows	Operable Windows
				Central Atrium	Central Atrium
As Natural Ventilation Chimney				Supported by Landscape Core	
Supported by Sky Gardens				Prevailing Wind Direction	
Effectiveness		25% Energy Saving	30% Energy Saving	Not Available	

(Drawn by Author, 2014)

3.4.1.2 Indirect Solar Gain

Its main purpose is controlling solar radiations, which are reached in an adjacent area that are not part of the building living space. Heat passes through windows into the building and thermal masses like masonry wall and water tank, trap and keep it and transmit it indirectly through conduction and convection to the building. At night, heat losses and slow response affect efficiency. As the indirect solar gain is not considered in the Tehran International Tower, the other two case studies are analyzed in this section. However, it should be mentioned that in these buildings, most parts of the facades benefit from this effect and the parts, which cover the green spaces benefit from solar direct gain.

3.4.1.2.1 The Frankfurt Commerzbank Tower, Germany

The innovative facade system consists of three layers. The inner layer, which is the main envelope, is a double-glazed hinged window. The outer layer is a fixed glass and the third layer is a cavity that lets the air flow inside at sill level and let it escape through a slot at the top of the window. Some blinds in the cavity cause the glare and solar heat gain in the office to reduce. Since these blinds are essentially external, unlike conventional blinds, they prevent heat from entering the building. Using this system makes it possible for the windows to be open even in driving rain or high winds. By improving thermal insulation properties of the windows up to 20% and natural ventilation the cavity caused Commerzbank to save 25-30% of the energy consumption (Foster & Partners, 2014).

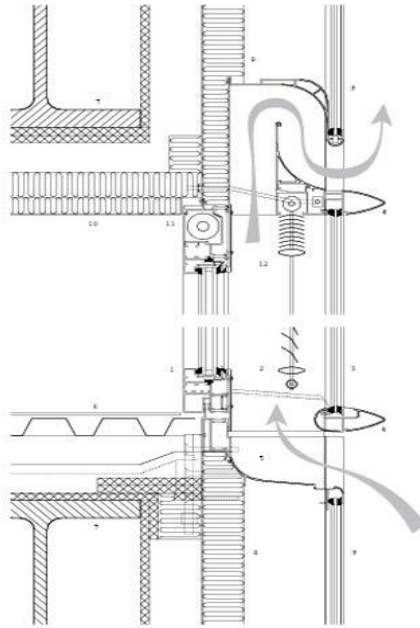

Figure 44. Frankfurt Commerzbank Facade System Details (Colin, 1997)

3.4.1.2.2 The Pinnacle Tower, UK

In designing the facade of the Pinnacle Tower especial attention has been applied. It is designed in a way that allows maximum amount of dilution to enter into the building. They are also preventing cold winds in winter by benefitting from the multilayered external walls that check both living units and individual garden terraces.

Mesh-screen wind-breaker elements reduce the inflow of strong winds, and adjustable, insulated shutter doors are supported by both large double-glazed windows and internal shutter doors that retain internal heat at night. Finally, the landscaping and planting of private gardens and communal sky-parks contribute and act as a wind buffer and are a kind of protection against solar radiation in summer to avoid overheating of indoor spaces. Thus, these considerations lead to saving approximately 35% of total building energy demand (Hamzah & Yeang, 2001).

In other words, the building exterior facade pays attention to both bioclimatic and aesthetic aspects of the London city environment. As mentioned, the elevation of this high-rise building is multi layered, whose outer layer is a versatile wind shield made of metal mesh. This layer can be opened in order to make ventilation better. The second layer is timber folding doors that are either short or angled to protect the terrace from the sun in summer and not to block the view out. To gain better insulation, the next layer is double glazing. Finally, in order to obtain further insulation properties, each apartment unit is distinguished with adjustable timber panel.

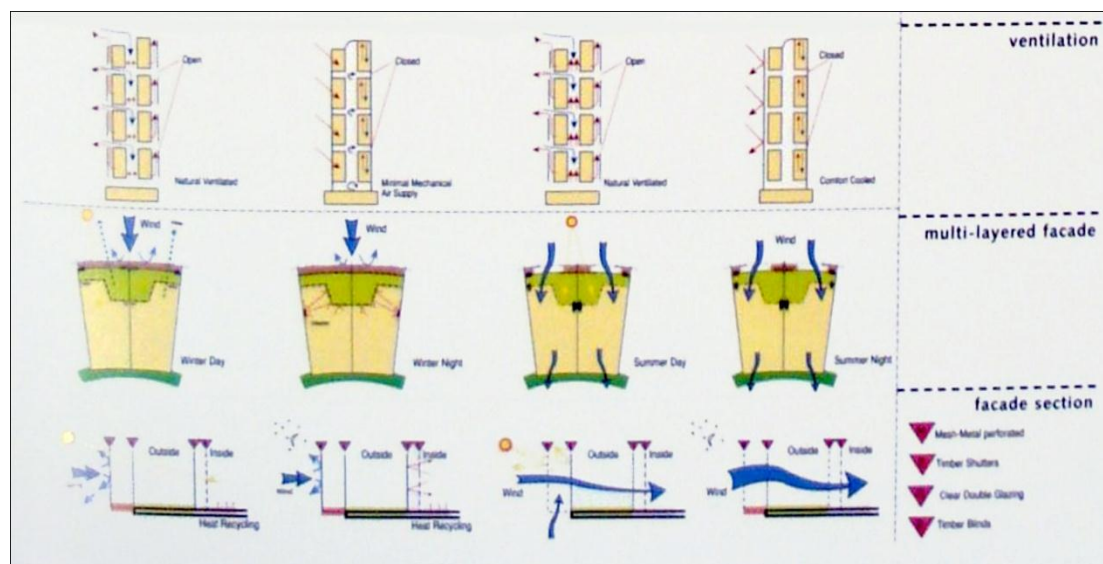

Figure 45. The Pinnacle Tower Multi Layered Facade System (Hamzah & Yeang, 2001)

Accordingly, the building multi-layer facade system in different seasons works as follows:

- On winter days the sun rays reach the facade nearly horizontally so in spite of the wind shield being drawn the rays penetrate the mesh and blinds.
- For higher energy efficiency in heating section all movable particles are drawn on cold winter nights.

- On breezy summer days, timber folding doors only let the desired amount of the sun rays enter the room and glass doors and wind shields are left open to let the breeze in and make an enjoyable atmosphere in terraces. The movable floor grating is also removed for inter-floor and cooling the metal mesh acts as sun shields
- In a hot summer night, all layers are open for maximum natural cooling and cross ventilation.

So, table 4, illustrates the result of analyzed case studies, in the case of indirect solar gain as an important factor of benefiting from passive solar strategies.

Table 4. Evaluating Case Studies from the Effect of Indirect Solar Gain

The Evaluation of High-Rise Buildings in Terms of Solar Energy Use						
Indirect Solar Gain Controlling Solar Radiations, Which Are Reached in an Adjacent Area	Considerations	Case Study 1	Case Study 2		Case Study 3	
		Tehran International Tower	Frankfurt Commerzbank Tower		Pinnacle Tower	
		Not Applied	3 Layers Facade System	Fixed Glass	4 Layers Facade System	Wind Shield of Perforated Metal Mesh
				Cavity Layer Between them		Timber Folding Doors
				Double-Glazed Hinged Window		Double Glazing
	Effectiveness	-----	25-30% Energy Saving		More Than 35% Energy Saving	
				Adjustable Timber Panel		

(Drawn by Author, 2014)

3.4.1.3 Isolated Solar Gain

As it was explained, this factor focuses on passively transmit solar radiation heat to the indoor spaces by benefiting a fluid, such as air or water through natural convection or forced convection. There are so many methods and elements in order to benefit from the isolated solar gain. However, the most important one in high-rise

buildings is using solar chimney and its effect. Passive solar energy heats the air through convection, which helps to improve building's natural ventilation.

Solar chimney can simply be described as vertical shaft, which is utilizing solar radiations in order to gain the natural stack ventilation, especially through high-rise buildings. In its simplest form, the solar chimney consists of a black-painted chimney. Throughout the day, sun radiations heat the solar chimney and the air within and makes it ascend. So, new air replaces it at the bottom of the chimney and causes cooling and ventilation (Afonso & Oliveira, 2000). The main point of solar chimney use is more beneficial in comparison to a windcatcher in order to provide ventilation on hot windless days.

By considering vents on top levels of construction, natural air ventilation can be obtained. In other words, this system allows the warm air to go upward to the building exterior; while it leads the cool air to come down to the lower levels simultaneously. It is obvious that in order to have a better circulation, solar chimney must be built at least a little higher than the roof level. It should also be constructed on the south facade, which gains the most amount of solar radiation and this effect can be improved by benefiting a glazed surface on that side of the building. Heat absorbing material can be used on the opposing side. The size of the heat-absorbing surface is more important than the diameter of the chimney.

3.4.1.3.1 The Frankfurt Commerzbank Tower in Frankfurt, Germany

In this case, the Frankfurt Commerzbank can be analyzed as a successful case study. Each office is benefiting from operable windows, which helps natural ventilation of the building almost throughout the entire year. As it was mentioned, four-storey gardens, which are located at different levels and directions, are actuated to provide

fresh air into the central atrium, act as a natural ventilation chimney for the building. Moreover, central atrium and the triangular shape of the building plan helped to create a zone with negative pressure, which itself caused the building's natural ventilation.

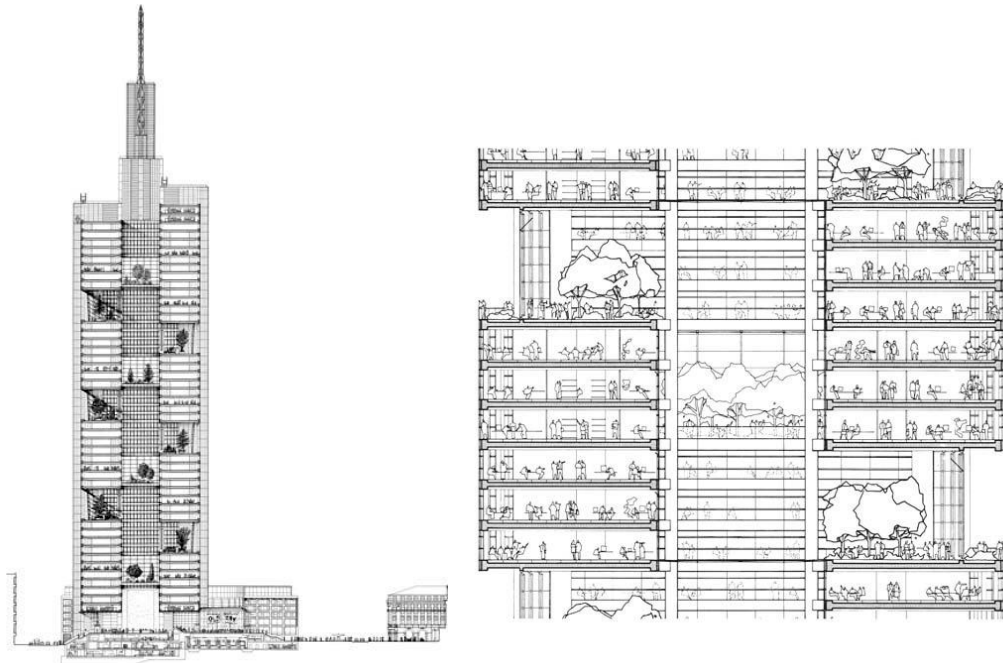

Figures 46 & 47. The Frankfurt Commerzbank Natural Ventilation Chimney (Campi, 2000)

In this case, this high-rise building was designed in order to be naturally ventilated for approximately 60% of the year, with the mentioned gardens being helped by natural ventilation process. This attempt was expected to decrease building energy demand by up to 45% compared to an ordinary mechanical air conditioned office systems. Accordingly, post occupancy studies have illustrated that this skyscraper in the reality consumes about 20% less energy than it was predicted, and this amount has been declining each year, since 2000. This is undoubtedly due to the building users, who benefited natural ventilation 85% of the year, while the designers had calculated 60% (Foster & Partners, 2014).

Furthermore, sky gardens are another important way of improving human enjoyment from the building, while simultaneously decrease the tower reliance on mechanical ventilation systems. They are also a privileged social gathering space and provide fresh oxygen and absorb CO₂. This idea could be applied to any other building and decrease energy consumption up to 45%, like Commerzbank.¹³

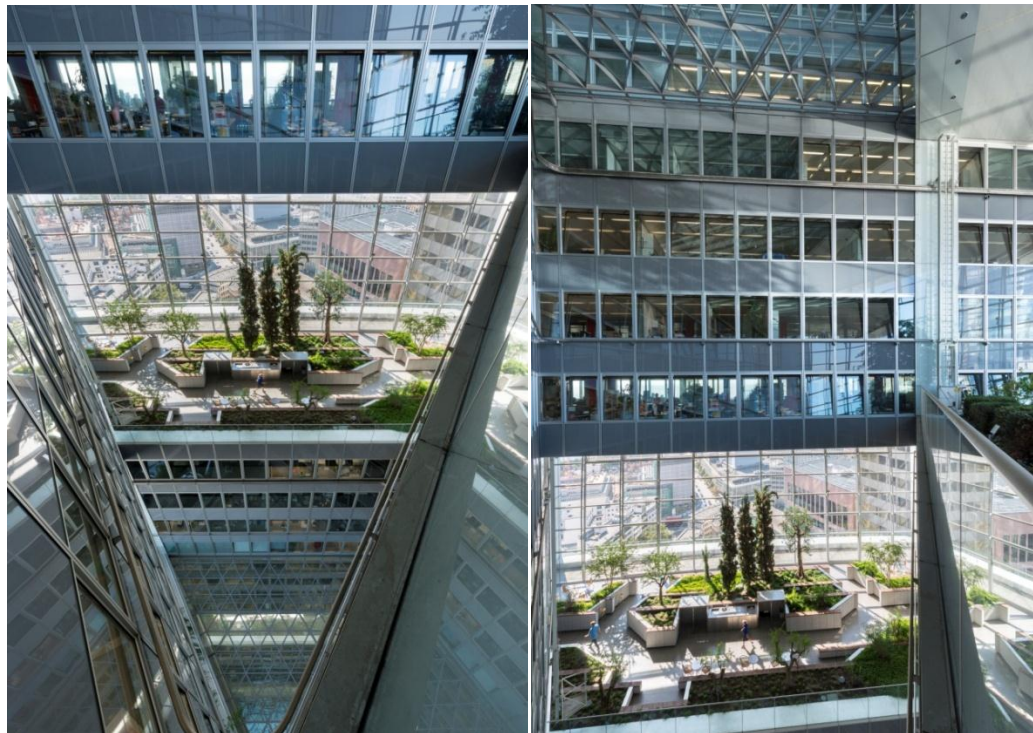

Figures 48 & 49. The Frankfurt Commerzbank Tower Natural Ventilation Chimney Supported by Sky Gardens (URL6, 2014)

3.4.1.3.2 The Pinnacle Tower London, UK

This skyscraper design is a common plan-form that has a radial arrangement. In other words, the apartments are creating a ‘fan’ arrangement on the northern and southern side of the project. The peripheral accommodation encloses an internal atrium, which rises through the building surrounded by a continuous landscaped ramp. This initial pedestrian circulation system creates the principal component of the skyscraper, which is fundamentally a radial-spiral shape. The site, which was defined as a closed

¹³ Norman Foster and Partners, personal communication, August, 2013

ecosystem by Yeang was rehabilitated by the planted facades and terraces that augmented the atrium landscaping.

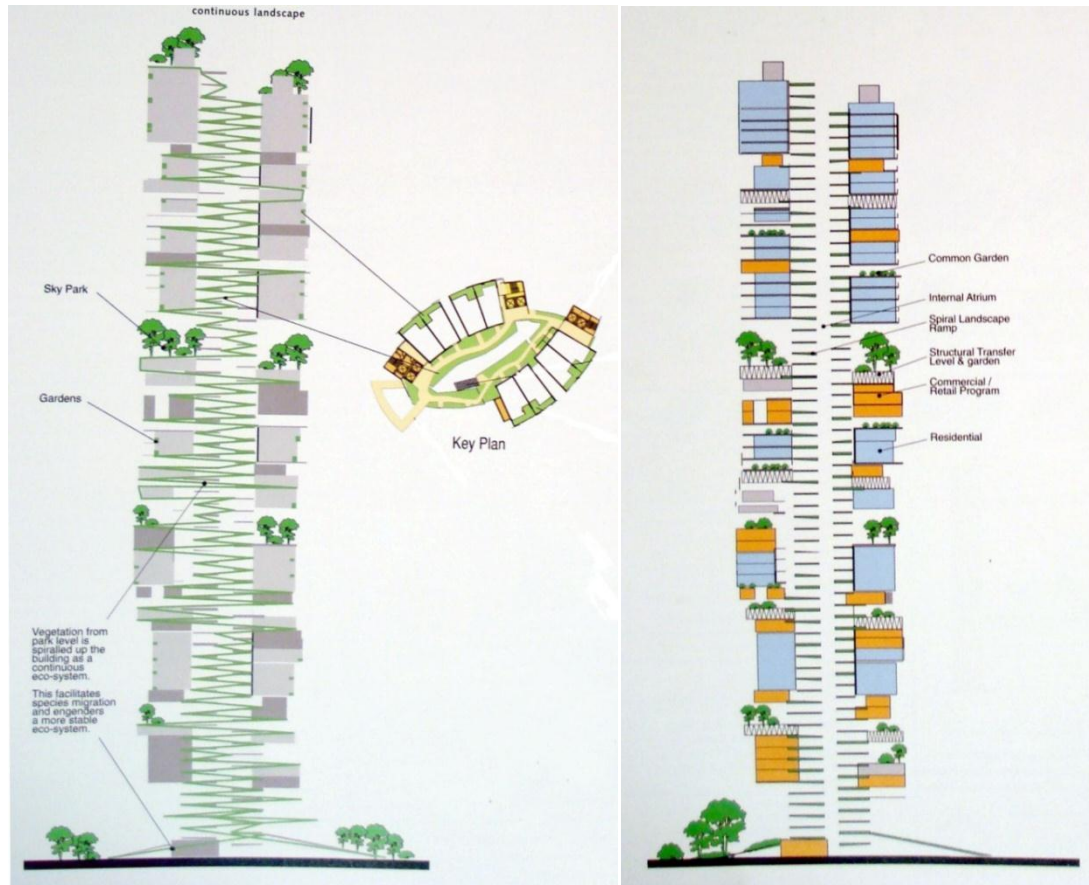

Figures 50 & 51. The Pinnacle Tower landscaped Ramp and Circulation System (Hamzah & Yeang, 2001)

Therefore, one of the main characteristics is the weather-protected landscaped core. The core is playing a significant role in gaining maximum solar radiation in winter and in mid-seasons. However, it is used as a type of shading system to protect the building from the summer sun. Moreover, these lift cores, which are situated on the northeast and west elevations, arrange a solar protective buffer zone for summer. However, in winter, low-angle sun radiations are able to enter the green spaced circulation atrium. Also the residential units, which are located on the southeast, gain maximum solar radiations.

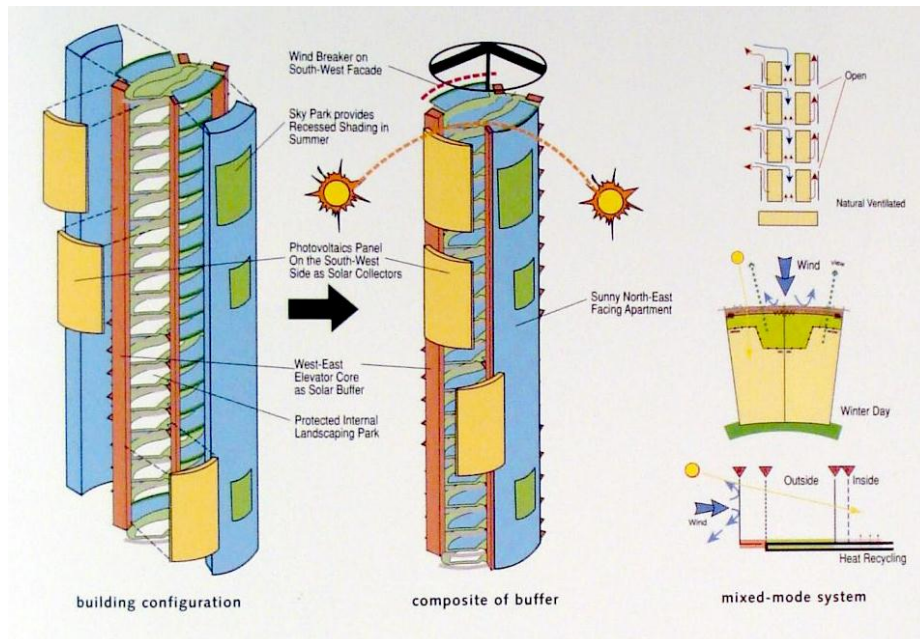

Figure 52: The Pinnacle Tower Building Configuration (Hamzah & Yeang, 2001)

Furthermore, one of the main design characteristics of this high-rise building is its vegetated terraces and well planted (green design) facades. These green spaces are continued to the ramp from the ground floor to the upper level of the tower. The entire green area of this building is approximately 40.700m², which has the ratio 1:1 of gross useable area to gross vegetated area. Vegetation and landscaping within the private gardens and sky-parks building act as a wind buffer, while giving users a more human environment. In summer, vertical landscaping acts to obstruct, absorb and reflects a high percentage of solar radiation, thus, reducing ambient temperatures. The damp surfaces of grass and soil will also contribute to a cooler and healthier building.

So, the following table shows the result of analyzing case studies, in the case of isolated solar gain as an important factor of benefiting from passive solar strategies.

Table 5. Evaluating Case Studies from the Effect of Isolated Solar Gain

The Evaluation of High-Rise Buildings in Terms of Solar Energy Use				
Isolated Solar Gain	Passively Transmit Solar Radiation Heat to the Indoor Spaces	Case Study 1	Case Study 2	Case Study 3
		Tehran International Tower	Frankfurt Commerzbank Tower	Pinnacle Tower
	Solar Chimney	Not Applied	Supported by: Central Atrium (Natural Ventilation Chimney) Operable Windows Four-Story Gardens	Supported by: Internal Atrium (Natural Ventilation Chimney) Continuous Landscaped Ramp Vegetated Teraces and Well Planted Facades Sky-Parks Building (Wind Buffer)
	Effectiveness	-----	About 45% Energy Saving	Not Calculated

(Drawn by Author, 2014)

3.4.1.4 Thermal Storage Mass

It is not possible to benefit from the solar radiations every moment. Therefore, in these situations, thermal mass or heat storage can be a good solution. Unfortunately, none of the above case studies meaningfully benefited from the effect of heat storage masses in their design. However, it must be noted that, for instance, in Frankfurt Commerzbank as a case of ecological architecture, while this skyscraper makes so many positive gestures in order to be environmental friendly, still there is the possibility of going further.

With all the natural light entering the building, there is no real thermal massing or other ways to store this free heat and have it radiated throughout the building. If garden floors were made of stone or tile instead of reflective surfaces, it would be yet another way to lower energy consumption. This fact can also be considered as a suggestion for the Pinnacle Tower, to use thermal mass materials in the flooring of

the sky parks. However, the weight of the above materials must be considered as a significant matter in designing high-rise buildings.



Figure 53. The Frankfurt Commerzbank Tower Sky Garden(suggested place for using thermal storage mass flooring) (Foster & Partners, 2014)

In this case, in double skin facade system design, a transparent layer can be positioned in front of solid wall with a high thermal mass, which provides thermal insulation. Therefore, the notable proportion of the absorbed solar energy is stored in the wall. Solar radiation penetrates the layer of transparent thermal insulation and is absorbed by the dark wall surface, where up to 95% of the radiation is converted into heat. Whereas the construction of the transparent thermal insulation virtually rules out any heat losses, the solid wall absorbs the heat, stores it and then releases it to the adjoining rooms after a delay of about 6-8 hours (Herzog, Krippner, & Lang, 2004).

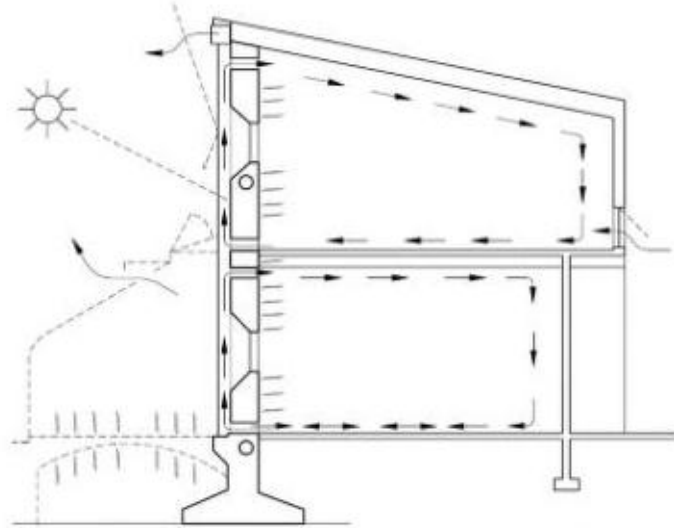

Figure 54. Sketch of the Trombe Wall Principle (Herzog, Krippner, & Lang, 2004).

The typical transparent thermal insulation materials include polymethyl methacrylate (PMMA), polycarbonate (PC) and glass. Very recently, cardboard honeycomb structures and sawn 'wooden slats' have been used (Herzog, Krippner, & Lang, 2004). Therefore, in order to select building elements, which are considered from performance requirements, knowledge acquisition and representation, 'Building Elements Selection System' (BES) can be used (Alibaba & Özdeniz, 2004).

As none of the case studies benefited from the thermal storage mass materials, the next table, displays the buildings current situation plus the author suggestions to improve the case studies.

Table 6. Evaluating Case Studies from the Effect of Thermal Storage Mass.

The Evaluation of High-Rise Buildings in Terms of Solar Energy Use				
Thermal Storage Mass	Using Thermal Mass or Heat Storage	Case Study 1	Case Study 2	Case Study 3
		Tehran International Tower	Frankfurt Commerzbank Tower	Pinnacle Tower
		Currently Employed	Not Applied	Not Applied
Potential to Use	No Suggestion	Using Thermal Mass Material in Facade System	Using Thermal Mass Material in Facade System	
Effectiveness	-----	-----	-----	

(Drawn by Author, 2014)

3.4.1.6 Passive Cooling

It is an effort to minimize the energy usage and to improve the indoor thermal comfort, which mostly focusses on heat dissipation and heat gain control. Passive cooling is related to the above mentioned factors. However, here, just innovative cooling system of Frankfurt Commerzbank will be analyzed, because the other case studies did not use passive cooling system.

The cooling system of this building is far more innovative (Fig. 55). Refrigerating machines that are environmentally friendly and attached to municipal streams absorb cool water and by circulating it through pipes in the ceiling panels, cool the building down without resorting to energy-intense air conditioning. Circulating air needs to be constantly replaced and needs much energy, while water can do the same with less energy. The tower does not provide hot water in the washrooms for economic and financial reasons. Instead, toilets are flushed with water, stored in towers and used in the cooling system (Colin, 1997). This mechanism conserves and reuses water as much as possible.

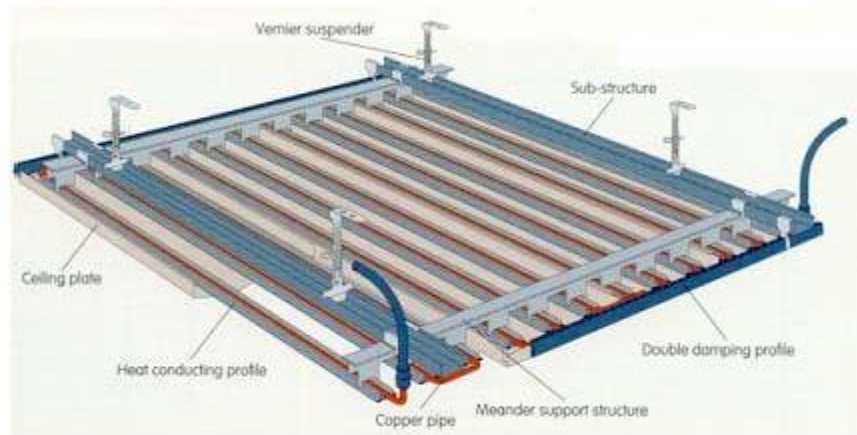

Figure 55. The Frankfurt Commerzbank Cooling System (Volker & Horst, 1997)

Central smart computers with their software programs (BUS-System)¹⁴ control and monitor all the above systems. For instance, when the weather is around the comfort temperature, all air conditioning system automatically shut down and a green indicator light, which is situated in every office, shows that windows should be opened. On the other hand, the red light indicates that the windows are automatically locked and there is a weather station on each garden level, monitoring air temperature, air pressure, solar radiation and wind speed/direction and gives it to the computer, which operates on an algorithmic system to learn when to switch modes, for the optimal balance between human comfort and energy efficiency (Colin, 1997). Therefore, according to Foster and Partners report (2014) the above considerations lead to approximately 5-7% saving in the total annual cooling energy demands (Foster & Partners, 2014).

In this part, since the Frankfurt Commerzbank is only benefiting from the passive cooling system, the following table illustrates the effectiveness of this factor in the case study.

¹⁴It is a system, which connect and control all computer systems in order to decrease costs and also modularity improvement.

Table 7. Evaluating Case Studies from the Effect of Passive Cooling

The Evaluation of High-Rise Buildings in Terms of Solar Energy Use					
Passive Cooling	heat dissipation and heat gain control		Case Study 1	Case Study 2	Case Study 3
			Tehran International Tower	Frankfurt Commerzbank Tower	Pinnacle Tower
		Passive Cooling System Design Considerations	Not Applied	Refrigerating Machines	Attached to Municipal Streams Absorb Cool Water Circulating Water Through Pipes in the Ceiling Panels Cool the Building Down without Resorting to Energy-Intense Air Conditioning
Effectiveness	-----	Toilets Are Flushed with Water, Being Stored in Towers and is Used in the Cooling System	About 5-7% Energy Saving	-----	

(Drawn by Author, 2014)

3.4.2 Active Solar Design

This type of solar technologies is mainly used in order to produce other useful types of energy from solar radiations. This new energy type is a kind of thermal energy to provide power generation, cooling, heating and hot water supply. Therefore, in the conversion process, one type of mechanical or electrical equipment is used and this is happening in order to maximize the effect of solar energy in buildings.

3.4.2.1 The Tehran International Tower, Iran

As it was completely discussed, in this case as a type of conventional case study, neither passive solar strategies, nor active solar technologies are used.

3.4.2.2 The Frankfurt Commerzbank Tower, Germany

In the case mentioned above, chilled ceilings provide cooling whereas heating derives from surrounding environment. To ensure that the mechanical ventilation is only active when the windows are closed, the windows are connected to the building management system (BMS). Motion sensors activate artificial lighting and all these make Commerzbank environmental systems pleasant and make us believe that by

observing some certain aspects they are an ideal start to an ecological approach of design (Foster & Partners, 2014).

3.4.2.3 The Pinnacle Tower London, UK

To achieve more sustainable design, gallium arsenide photovoltaic cells combined with a rainwater catchment or a rain-screen in south-east facade are used. PV panels are utilized in order to obtain more energy self-sufficient building and sustainability. The following table illustrates the amount of annual energy usage of the Pinnacle Tower.

Table 8. The Pinnacle Tower Annual Building Energy Usage

Type	Area (m ²)	Energy (kWh/m ²)	Annual Energy Consumption (kWh)
Housing	22990	200	4.598.000
Retail	8660	250	2.165.000
			6,763,000

(Hamzah & Yeang, 2001)

Therefore, in this case by covering the entire south east elevation, which includes ramp and PV panels with 30° angle (fig. 56), the total covered area can be calculated as follows:

$$31\text{m} \times 0.5\text{m} \times 50 \text{ (storeys)} = 775\text{m}^2$$

Considering the potential power output, it is estimated that photovoltaic panels' efficiency is about 13%, which means 100kWp (kW peak). Potential energy generated from a 100kWp source, in the best situations, with no shading effect of other high-rise buildings, optimal PV angles and building orientation, it can annually generate approximately 70,000kWh. However, by considering the actual situation such as locating PV tiles in the southeast facade, instead of south, this amount is reduced to about 50,000 kWh. Therefore, according to table 9 these PV panels can

provide nearly 0.7% of the entire annual building energy needs (Hamzah & Yeang, 2001).

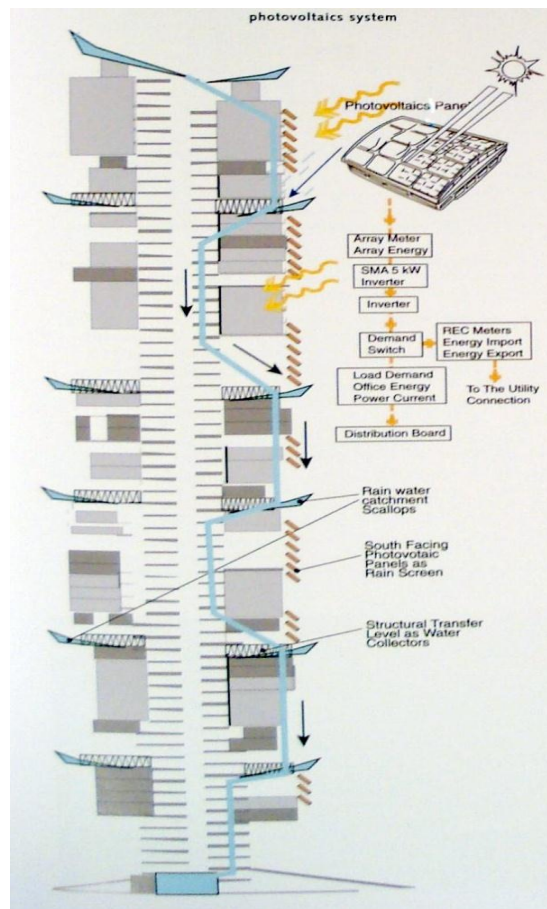

Figure 56. Photovoltaics System (Hamzah & Yeang, 2001)

Apart from the above considerations, the most widely used wind turbine types are the upwind, three-blade horizontal axis type, whether the rotor spins in front of the tower about a line parallel to the horizon. The vertical axis primarily lift type turbines are not so efficient in energy production and their use can be justified as an architectural element of the integrated design for this building. To obtain sufficient power from a single turbine ($50\text{KW} <$), typical dimensions of the main mast and the blades are 30m and 10-15m respectively, making this type of application unsuitable for the site.

However, using smaller turbines about 6-10kw, with the blade size of approximately 4.5m is more appropriate for this building. Furthermore, most applications use tail vanes to point the rotor into the wind. Finally, it should be mentioned that the effect of using these type of generators can lead to producing about 1% of building annual total energy consumption. Also from the economical point of view the payback period of the turbine, which is used here is about 23 years (Hamzah & Yeang, 2001).

The following table shows the effect of using active solar and other sustainable technologies in the Pinnacle tower in comparison with the other cases, which do not benefit from these types of technologies.

Table 9. Evaluating Case Studies from the Effect of Using Active Solar Technologies

The Evaluation of High-Rise Buildings in Terms of Solar Energy Use								
		Case Study 1		Case Study 2		Case Study 3		
		Tehran International Tower		Frankfurt Commerzbank Tower		Pinnacle Tower		
Active Solar Design Technology Used to Produce Other Useful Types of Energy from Solar Radiations	Active Solar Technology		Not Applied	Not Applied	Photovoltaic Panels			
					Type	100 kWp		
					Panels' Efficiency	13%		
					Panels' Actual Power	50 Mwh		
	Effectiveness		----	----	Provide 0.7% of the Entire Annual Building Energy			
	Other Active and Sustainable Technologies		No Suggestion		No Suggestion		Wind Turbine	
							sufficient power	6-10 kw
							Size	Main Mast 30 m Blades 10-15 m
	Effectiveness		----	----	Producing 1% of Building Annual Total Energy			

(Drawn by Author, 2014)

Finally, to sum up the above data, the author tries to summarize the information of each case study in one table, and also present them in one table in order to better comparison.

Table 10. The Evaluation of the Tehran International Tower

The Evaluation of High-Rise Buildings in Terms of Solar Energy Use							
Case Study 1			Tehran International Tower				
Basic Information		Passive Solar Design Strategies					
Normal High-Rise Building		Orientation	Direct Solar Gain		Indirect Solar Gain		
Climate Zone	Temperate		Standard Angles	Actual Angles	Composing the 3 Wings Angle of 120°	Not Applied	
Function	mixed-use complex		Axies Angle	Orientation Consideration			
Location	Tehran/ Iran	Shading Devices	Type	Egg Crate Shading Devices			
Height	164m		Standard Size	95 × 95cm			
Area	220,000m ²		Actual Size	120 × 120m			
		Daylighting	Consideration		Huge Vertical Windows		
			Ventilation	Operable Windows			
		Effectiveness		About 15% Energy Saving		-----	
Active Solar Design Technology		Isolated Solar Gain		Thermal Storage Mass		Passive Cooling	
Active Solar Technology	Not Applied	Solar Chimney	Not Applied	Currently Employed	Not Applied	Passive Cooling System Design Considerations	Not Applied
				Potential to Use	No Suggestion		
Effectiveness	-----	-----	-----	-----	-----	-----	-----

(Drawn by Author, 2013)

Table 11. The Evaluation of the Frankfurt Commerzbank Tower

The Evaluation of High-Rise Buildings in Terms of Solar Energy Use							
Case Study 2			Frankfurt Commerzbank Tower				
Basic Information		Passive Solar Design Strategies					
Passive Design High-Rise Building		Orientation	Direct Solar Gain		Indirect Solar Gain		
Climate Zone	Temperate		Standard Angles	Actual Angles	South-West Direction	Fixed Glass	
Function	mixed-use complex		Axies Angle	Orientation Consideration			
Location	Frankfurt / Germany	Shading Devices	Type	Not Applied			
Height	259m		Standard Size	Other Consideration	Sky Gardens		
Area	125,000m ²		Actual Size				
		Daylighting	Consideration		Vast Transparent Windows		
			Ventilation	Operable Windows		Sky Gardens	
		Effectiveness		More Than 20% Energy Saving		25-30% Energy Saving	
Active Solar Design Technology		Isolated Solar Gain		Thermal Storage Mass		Passive Cooling	
Active Solar Technology	Not Applied	Central Atrium (Natural Ventilation Chimney)	Supported by:	Currently Employed	Not Applied	Passive Cooling System Design Considerations	Refrigerating Machines
			Operable Windows	Potential to Use	Using Thermal Mass Material in Facade System		Attached to Municipal Streams Absorb Cool Water
Effectiveness	-----	-----	About 45% Energy Saving	-----	-----	-----	Toilets Are Flushed with Water, Being Stored in Towers and is Used in the Cooling System

(Drawn by Author, 2013)

Table 12. The Evaluation of the Pinnacle Tower

The Evaluation of High-Rise Buildings in Terms of Solar Energy Use												
Case Study 3					Pinnacle Tower							
Basic Information		Passive Solar Design Strategies										
Passive Design High-Rise Building		Direct Solar Gain				Indirect Solar Gain						
Climate Zone	Temperate	Orientation	Standard Angles		4 Layers Facade System				Wind Shield of Perforated Metal Mesh			
Function	mixed-use complex		Actual Angles	Axies Angle							North-East Direction	
Location	London/ UK		Orientation Consideration								30°	
Height	288m	Shading Devices	Type		Not Applied				Timber Folding Doors			
Area	81,400m ²		Standard Size								Other Consideration	Weather Protected Landscape Core
		Daylighting	Actual Size		Vast Transparent Windows				Double Glazing			
			Consideration								Sky Gardens	
			Ventilation								Operable Windows	
Active Solar Design Technology		Effectiveness			Not Available			About 35% Energy Saving				
Active Solar Technology		Isolated Solar Gain			Thermal Storage Mass			Passive Cooling				
Active Solar Technology	Photovoltaic Panels	Central Atrium (Natural Ventilation Chimney)	Supported by:		Currently Employed	Not Applied						
	Type		100 kWp									
	Panels' Efficiency		13%									
Other Active and Sustainable Technologis	Panels' Actual Power		Continuous Landscaped Ramp		Potential to Use	Using Thermal Mass Material in Facade System						
	Wind Turbine sufficient power		Vegetated Teraces and Well Planted Facades									
	6-10 kw Size		Sky-Parks Building (Wind Buffer)									
Main Mast	Blades											
30 m	10-15 m											
Effectiveness	Producing 1.7% of the Annual Total Energy	Not Calculated			----			----				

(Drawn by Author, 2013)

Table 13. The Evaluation of Case Studies in Terms of Solar Energy Use

The Evaluation of High-Rise Buildings in Terms of Solar Energy Use											
Basic Information	Case Study 1		Case Study 2		Case Study 3						
	Telran International Tower		Frankfurt Commerzbank Tower		Pinnacle Tower						
	Normal High-Rise Building		Passive Design High-Rise Building		Active & Passive Design High-Rise Building						
	Climate Zone		Temperate		Temperate						
	Function		mixed-use complex (Residential)		mixed-use complex (Bank)			mixed-use complex (Residential)			
	Location		Telran/ Iran		Frankfurt am. Main/ Germany			London/ U.K			
	Height		164m		259m			288m			
	Area		220,000m ²		125,000m ²			81,400m ²			
Plan Shape											
Direct Solar Gain Value of Direct Solar Radiations, Obtained in the Living Spaces	Orientation	Standard Angles		Composing the 3 Wings Angle of 120°		South-West Direction		North-East Direction			
		Actual Angles		---		16°		30°			
		Orientation Consideration		---		---		Prevailing Wind Direction			
	Shading Devices	Type		Egg Crate Shading Devices		Not Applied		Not Applied			
		Standard Size		95 × 95cm		Other Consideration		Sky Gardens			
	Actual Size		120 × 120m		Other Consideration		Weather Protected Landscape Core				
	Daylighting	Consideration		Huge Vertical Windows		Vast Transparent Windows		Vast Transparent Windows			
		Consideration		Operable Windows		Sky Gardens		Landscape Core			
	Ventilation	Consideration		Operable Windows		Operable Windows		Operable Windows			
		Consideration		Operable Windows		Central Atrium		Central Atrium			
Consideration		Operable Windows		As Natural Ventilation Chimney		Supported by Landscape Core					
Consideration		Operable Windows		Supported by Sky Gardens		Prevailing Wind Direction					
Effectiveness		About 15% Energy Saving		More Than 20% Energy Saving		Not Available					
Indirect Solar Gain Consulting Solar Radiations, Which Are Reached in an adjacent area	Consideration	Not Applied		3 Layers Facade System		Wind Shield of Perforated Metal Mesh		Wind Shield of Perforated Metal Mesh			
		Not Applied		3 Layers Facade System		Cavity Layer Between them		Timber Folding Doors			
		Not Applied		3 Layers Facade System		Double-Glazed Hinged Window		Double Glazing			
	Effectiveness		---		25-30% Energy Saving		4 Layers Facade System		Adjustable Timber Panel		
Effectiveness		---		25-30% Energy Saving		4 Layers Facade System		Adjustable Timber Panel			
Passive Solar Design Strategies Isolated Solar Gain Passively Transmitted Solar Radiation Heat in the Living Spaces	Solar Chimney		Not Applied		Central Atrium (Natural Ventilation Chimney)		Supported by:		Supported by:		
	Solar Chimney		Not Applied		Central Atrium (Natural Ventilation Chimney)		Operable Windows		Continuous Landscaped Ramp		
	Solar Chimney		Not Applied		Central Atrium (Natural Ventilation Chimney)		Four-Story Gardens		Vegetated Terraces and Well Planted Facades		
Effectiveness		---		30-45% Energy Saving		Sky-Parks Building (Wind Buffer)		35% Energy Saving			
Thermal Storage Mass Using Thermal Mass or Heat Storage Potential in the Heat Storage	Currently Employed		Not Applied		Not Applied		Not Applied		Not Applied		
	Way of Achieving	No Suggestion		Using Thermal Mass Material in Facade System		Using Thermal Mass Material in Facade System		Using Thermal Mass Material in Facade System		Using Thermal Mass Material in Facade System	
		No Suggestion		Sky Garden Floors		Continuous Landscaped Ramp		Continuous Landscaped Ramp		Continuous Landscaped Ramp	
Effectiveness		---		---		---		---			
Passive Cooling Heat dissipation and heat gain control	Passive Cooling System Design Considerations		Not Applied		Refrigerating machines		Not Applied		Not Applied		
	Passive Cooling System Design Considerations		Not Applied		Attached to Municipal Streams, Absorb Cool Water		Circulating Water Through Pipes in the Ceiling Panels		Cool the Building Down without Resorting to Energy-Intense Air Conditioning		
Effectiveness		---		Toilets Are Flushed with Water, Being Stored in Towers and Is Used in the Cooling System		---		---			
Active Solar Design Technology Used to Produce Other Useful Types of Energy from Solar Radiations	Active Solar Technology		Not Applied		Not Applied		Photovoltaic Panels		Photovoltaic Panels		
	Active Solar Technology		Not Applied		Not Applied		Type		100kWp		
	Active Solar Technology		Not Applied		Not Applied		Panels' Efficiency		13%		
	Active Solar Technology		Not Applied		Not Applied		Panel's Actual Power		50 MWh		
Other Sustainable Technologies	Potential Opportunities		No Suggestion		No Suggestion		Wind Turbine		sufficient power		
	Potential Opportunities		No Suggestion		No Suggestion		Main Mast		6-10kw		
	Potential Opportunities		No Suggestion		No Suggestion		Blades		30m		
Effectiveness		---		---		Blades		10-15m			
Effectiveness		---		---		Blades		10-15m			

(Drawn by Author, 2013)

Chapter 4

CONCLUSION

In today's world, one of the current fundamental challenges is the sustainability agenda, in both global and local scales. All around the world, while trying to improve life's quality, communities are trying to find a way to decline their vulnerable impacts on the environment. Another probable challenge is the climate change. It represents a critical factor to incorporate long term thinking into the building's energy design.

Apart from continuous economic development and living standard improvements, the annual world population growth, which is about 2% will lead to more energy demand. This rate is expected to become doubled by 2050. Consequently, as it was discussed, global demand for energy services is expected to increase about up to 10 times by 2050 and primary energy demand will approximately increase from 1.5 to 3 times more.

Hence, at present, the population growth leads to the need for more buildings. So, the important role of high-rise buildings is inevitable. It seems that finding new alternative energy sources is unavoidable, particularly in tall buildings with their great ability and potential to use sustainable sources, because of their height. In high-rise buildings, architects may need to develop further separate systems for different levels of the building to cope with the variables, both vertically and across the

different faces of the skyscraper. New buildings are increasingly user-friendly, offering a comfortable occupant-controlled environment all year.

Therefore, to find new alternatives, this study tried to analyze the way solar radiation can be considered as a source of renewable energy in order to reduce the high-rise building's energy demands compared with the use of fossil fuels. The research began with the hypothesis that simple solar design strategies have a significant effect on decreasing the total annual high-rise building energy consumption. However, sufficient attention has not been paid to them. So, in order to fill the gap caused by not being a proper evaluation of different aspects of solar energy in high-rise buildings, the research has reviewed the concepts and knowledge system of utilizing the passive solar strategies and active solar technologies on designing high-rise buildings. Furthermore, with the aid of the case studies, the research analysis tries to find the logical and orderly discipline to categorize the effectiveness of different factors in benefiting solar radiations, which was also the ultimate expectation of this study.

After introducing the subject and determining its purpose and importance, the research reviewed the theoretical background of the study and several factors involved in the debate over the scholarly value of the sustainability matter. The second chapter involved the energy criteria, crisis, identifying the role of buildings in creating the problem and also described energy efficiency trends and policies. Then, it discussed renewable energy sources and their effects. Finally, the high-rise building background has been studied. Afterwards, as it was mentioned, the main focus of the discussion part was the evaluation of solar energy as a potential to save energy and gain more sustainable high-rise buildings.

In order to evaluate high-rise buildings in terms of solar energy, the author analyzes the case studies from both passive solar strategies and active solar technologies' aspects. In the first phase; direct solar gain, indirect solar gain, isolated solar gain, thermal storage mass and passive cooling as a meaningful factor to obtain passive strategies are evaluated and the results are summarized in the table available in 'appendix A'. As just one of the cases benefited solar active technology, this factor is analyzed in the Pinnacle Tower and its effective results were compared with the results of the other case studies.

In brief, for analyzing the direct solar gain; orientation, shading devices and daylighting are considered as the main critical criteria. Although the Tehran International Tower architects haven't got the intention to apply the passive solar strategies, some of the principles of these strategies appeared to be applied. For instance, by constructing the building composing of the three wings with the angle of 120° , benefiting the huge vertical windows covered by egg crate shading devices, this building can benefit from daylighting and solar radiations in every direction. However, as it was discussed, by positioning the egg crate devices in all directions, their effectiveness will be reduced. Therefore, these considerations lead to approximately 15% energy savings (Table 10).

In the second case - the Frankfurt Commerzbank Tower, as a case of passive solar design - this amount of energy saving increased to about 20%, by 16° oriented to south-west direction and benefiting from sky gardens and also big size of transparent windows, which both lead to better ventilation as well (Table 11). Finally, in the last case, the Pinnacle Tower, which is considered as a both active and passive design high-rise building; 30° orientation to north-east direction and weather protected

landscape core, which is supported by operable transparent windows considered as effective factors in order to gain direct solar radiations (Table 12).

In order to understand the effect of indirect solar gain, the different multiple façade systems are analyzed. Although the Tehran International Tower does not benefit from the indirect solar gain, in the Frankfurt Commerzbank and the Pinnacle Tower triple and four fold layer facade system has a meaningful effect on the buildings' energy demands. So, the result illustrates that energy reduction is about 25-30% in the Frankfurt case and it is approximately 35% in London case.

The next factor is isolated solar gain, which due to the research limitations, the solar chimney effect. Thus, in this section, in the Frankfurt Commerzbank and the Pinnacle Tower, central atriums are used as type of natural ventilation chimney, which are supported by operable windows and some kinds of green spaces. Apart from these considerations, the Pinnacle Tower benefited from the prevailing wind direction in the atrium. So, according to the previews section analysis, the above factors can reduce about 45% energy usage in Frankfurt tower.

Unfortunately, none of these high-rise buildings benefited from the thermal storage mass capacity, but the last two cases can gain this character by changing their green spaces floor with some kind of thermal mass storage materials. As the material weight is a significant factor in designing high-rise buildings, the more practicable suggestion is to apply these types of considerations in the facade system design. Eventually, according to Foster and Partners report (2014) the innovative passive cooling system in the Frankfurt Commerzbank, decreases about 5-7% of the total annual cooling energy demands.

Finally, high-rise buildings have great potential to gain solar radiations because of their vast facades. Analyzing case studies illustrate that applying solar passive strategies in high-rise buildings have a meaningful effect on reducing the total annual cooling and heating energy demand. These strategies can be applied and adapted to high-rise buildings by using direct solar gain, indirect solar gain, isolated solar gain, thermal storage mass and passive cooling systems. On the other hand, considering active solar technologies can also add extra potential by providing part of the building necessary energy demands. Although this amount is not huge amount in the case studies, it can be improved by integrating PV panels and other solar active technologies in the high-rise building facades.

4.1 Implications for Further Studies

In the world affected by global warming and uncertainty over the long term energy supplies, it is truly consequential to find some ways and principals to diminish energy usage. In this case, in order to continue and fullfill other researchers' attempts, which are looking for ways of reducing energy consumption or finding some sustainable alternatives instead of combusting fossil fuels, this research mainly focused on some neglected aspect of solar energy effects on high-rise buildings. This hypothesis mainly emphasized on adaptation of solar passive and active strategies and technologies in high-rise buildings, which most of them can just be reached by a little consideration in the design process. Therefore, this new trend of sustainability will undoubtedly become a new important direction of construction innovation in near future.

In effect, several research areas have determined for further studies, which were figured out, while undertaking the current research. The analysis has helped us to

identify the common characteristics of the neglected benefited of different aspect of passive solar strategies and active solar technologies in designing high-rise buildings, which in fact are the responds to the questions proposed in the study. As it is almost an initial attempt in order to investigate the effect of different criteria in using solar energy in tall buildings, it requires more studies.

Therefore, this study can show architects a new point of view to encounter the sustainability in their project designs. Furthermore, architects as the ones, who have the authority of controlling the building energy efficiency in their designs, can decide, which factor has more impact on their projects due to their limitations and can concentrate more on it. This study is a pioneer in this field, so that some main points may have been neglected that need to be improved, but it tried to step in a way, which will surely be worked on in future studies.

REFERENCES

Afgan, N. & Carvalho, M. (2004). Sustainability assessment of hydrogen energy systems. *Int Journal of Hydrogen Energy* , 29 (13), 1327–42.

Afonso, C. & Oliveira, A. (2000). Solar chimneys: Simulation and experiment. *Energy and Buildings* , 32 (1), 71-79.

Akella, A., Saini, R. & Sharma, M. (2009). Social, economical and environmental impacts of renewable energy systems. *Renewable Energy* , 34, 390–6.

Alibaba, H. Z. & Özdeniz, M. B. (2004). A building elements selection system for architects. *Building and Environment* , 39, 307-316.

Al-Mansour, F. (2011). Energy efficiency trends and policy in Slovenia. *Energy* , 36, 1868e1877.

America's Climate Choices (Pap/Cdr ed.). (2011). National Academies Press.

Anink, D., Boonstra, C. & Mak, J. (1996). *Handbook of sustainable building; an environmental preference method for selection of materials for use in construction and refurbishment*. (A. Morris, Trans.) London, UK: James & James 9Science Publishers) Limited.

Anisimov, O., Nelson, F. & Shiklomanov, N. (1997). Global warming and active-layer thickness: Results from transient general circulation models. *Global and Planetary Change*, 15 (3–4), 61–77.

Anon. (1995). *Urban Energy Handbook*. Paris: OECD.

Azar, C. (2003). *Emerging scarcities—bioenergy—food competition in a carbon constrained world*. (M. Ayres, & D. Toman, Eds.) John Hopkins University Press.

Bakic, V., Jovanovic, M., Pezo, M., Turanjanin, V. & Vucicevic, B. (2011). Sustainability estimation of energy system options that use gas and renewable resources for domestic hot water production. *Energy*, 36, 2169e2175.

Barnett, J. (2013). *Climate Change*. Melbourne: Melbourne University.

Bauer, M., Mösle, P. & Schwarz, M. (2010). *Green building: Guidebook for sustainable architecture*. Heidelberg, Dordrecht, London, New York: Springer.

Beaver, R. (Ed.). (2005). *Mainstream Green Sustainable Design by LPA*. Mulgrave, Australia: The Images Publishing Group Pty Ltd.

Bershanskii, A. (2009). Transitional solar dynamics and global warming. *Physics A: Statistical Mechanics and its Application*, 388 (15–16), 3213–24.

Bhat, I. K., Prakash, R. & Varun. (2009). Energy, economics and environmental impacts of renewable energy systems. *Renewable and Sustainable Energy Reviews* , 2716–2721.

Bilgen, S., Kaygusuz, K., S, Ocak, M. & Ocak, Z. (2004). Energy utilization, environmental pollution and renewable energy sources in Turkey. *Energy Conversion and Management* , 45, 845–864.

Blok, K. (2005). Enhanced policies for the improvement of electricity efficiencies. *Energy Policy* , 33 (13), 1635–41.

Boardman, B. (2007). Examining the carbon agenda via the 40% house scenario. *Journal of Building Research and Information* , 35 (4), 363-378.

Buchanan, P. (2012, January 30). *The Architectural Review*. Retrieved October 26, 2013, from <http://www.architectural-review.com/the-big-rethink-farewell-to-modernism-and-modernity-too/8625733.article>

Burnie, G. (2008). Technical Analysis; EIFS panels vs. GFRC panels. *Baltimore Washington Medical Center Journal* .

Campi, M. (2000). *Skyscrapers: an architectural type of modern urbanism*. Boston: Birkhäuser.

Chan, B. (1997). Banking on Ventilation. *Architect's Journal* , 202, 36-39.

Chan, Y. (2007). *Contemporary design in detail; Sustainable environments*. USA: Rockport Publishers, Inc.

Chauvin, F., Deque, M., Planton, S. & Terray, L. (2008). Expected impacts of climate change on extreme climate events. *Comptes Rendus Geosciences* , 340 (9–10), 564–74.

Chiras, D. (2002). *The solar house: Passive heating and cooling*. Chelsea Green Publishing Company.

Colin, D. (1997). *Commerzbank, Frankfurt*. UK: Surrey: Watermark Publications.

Daniels, K. (1997). *The Technology of Ecological Building; Basic principles and measures, examples and ideas*. (E. Schwaiger, Trans.) Berlin, Germany: Birkhauser Verlag.

DCLG. (2009). *Definition of Zero Carbon Homes and Non-Domestic Buildings*. Department of Communities and Local Government, [/http://www.communities.gov.uk/publications/planningandbuilding/newnondomesticconsultS](http://www.communities.gov.uk/publications/planningandbuilding/newnondomesticconsultS).

DEFRA. (2007). *Draft Climate Change Bill*. The Stationery Office, Cm 7040, Department of the Environment, Food and Rural Affairs.

Dincer, I. (1999). Environmental impacts of energy. *Energy Policy* , 27, 845-854.

Dincer, I. (2000). Renewable energy and sustainable development: a crucial review. *Renewable and Sustainable Energy Reviews* , 4 (2), 157–75.

Dincer, I. & Rosen, M. A. (2005). Thermodynamic aspects of renewables and sustainable development. *Renewable and Sustainable Energy Reviews* , 9, 169–189.

Dodoo, A., Gustavsson, L. & Sathre, R. (2011). Building energy-efficiency standards in a life cycle primary energy perspective. *Energy and Buildings* , 43, 1589–1597.

Doerr, T. (2012). *Passive Solar Simplified; Easily Design a Truly Green Home* (1st ed.). Colorado, US: Alitheia Press.

Doji, N., Koltea, S. S., Murthy, M. S., Polema, B., Patila, Y. S. & Sharma, S. V. (2011). Revolving doors producing green energy. *IEEE First International Conference on Clean Energy and Technology CET* (pp. 157-160). Malaysia: IEEE Conference Publications.

Dupre, J. (2008). *Skyscrapers; A History of the Worlds Most Extraordinary Buildings* (2nd ed.). New York, US: Black Dog & Leventhal Publishers.

Eisele, J. & Kloft, E. (Eds.). (2003). *High-rise manual: Typology and design, construction and technology*. Basel, Boston, Berlin: Birkhäuser-Publishers for Architecture.

Emadi, B. & Lotfabadi, P. (2011). Renewable Energies in Architecture. *Technical Magazine of KCEDO* , 49-50, 77-81.

Foster & Partners. (2014). *Foster + Partners*. Retrieved February 11, 2014, from <http://www.fosterandpartners.com/projects/commerzbank-headquarters/>

Frenside, P. (2007). Time preference in global warming calculations: a proposal for a unified index. *Ecological Economics* , 41 (1), 21-31.

Frey, G. W. & Linke, D. M. (2002). Hydropower as a renewable and sustainable energy resource meeting global energy challenges in a reasonable way. *Energy Policy* , 30, 1261–1265.

Fyfe, J., Harner, T. & Macdonald, R. (2005). Recent climate changes in the Arctic and its impact on contaminant pathways and interpretation of temporal trend data. *Science of the Total Environment* , 342 (1–3), 5–86.

Goic, R., Iniyar, S. & VenkataRaman, S. V. (2012). A review of climate change, mitigation and adaptation. *Renewable and Sustainable Energy Reviews* , 16, 878–897.

Goldemberg, J. & Coelho, S. T. (2004). Renewable energy—traditional biomass vs. modern biomass. *Energy Policy* , 32, 711–714.

Hacking, T. (2009). Improved energy performance in the built environment: unpicked ‘low-hangingfruit’? In: *Proceedings of the Conference on Building Physics and the Sustainable City*. Cambridge: University of Cambridge.

Hamzah, T. R. & Yeang, K. (2000). *Bioclimatic Skyscrapers*. London: Ellipsis London Pr Ltd.

Hamzah, T. R. & Yeang, K. (2001). *Ecology of the sky*. Australia: The Image Publishing Group Pty Ltd.

Hannan, D. (2010, November 1). Retrieved December 27, 2013, from The Ultimate Energy Paradigm Shift — The Urgent Need for Renewable Power: <http://camwest.pps.com.au/renewable-energy/#Figure 3>

Heath, T. (1980). *A History of Greek Mathematics* (Vol. 2). Oxford: Dover Publications, Inc.

Hegger, M., Fuchs, M., Stark, T. & Zeumer, M. (2008). *Energy manual: Sustainable architecture*. Basel, Boston, Berlin: Birkhäuser Verlag AG.

Herzog, T., Krippner, R. & Lang, W. (2004). *Facade Construction Manual* (1st ed.). (S. Lenzen, & C. Fritzenwallner, Eds.) Basel, Switzerland: Birkhauser.

Holmberg, J. & Nassen, J. (2005). Energy efficiency—a forgotten goal in the Swedish building sector? *Energy Policy*, 1037–1051.

Hui, S. (1997). From renewable energy to sustainability: The challenge for Hong Kong. *the POLMET '97 Conference* (pp. 351–8). Hong Kong: Hong Kong Institution of Engineers.

Hvelplund, F. (2006). Renewable energy and the need for local energy markets. *Energy* , 31 (13), 2293–302.

IEA. (2008). *Energy technology perspectives: Scenarios & strategies to 2050, Report of the Organisation for Economic Co-operation Development (OECD)*. Paris.

IEA. (2006). *International Energy Agency*. Paris: World Energy Outlook OECD/IEA.

IEA. (2013). *Key World Energy Statistics*. Retrieved March 12, 2014, from International Energy Agency: <http://www.iea.org/publications/freepublications/publication/name,31287,en.html>

IEA. (2000). *World energy outlook*. Paris, France: International Energy Agency.

IPCC. (2013). *United Nations Intergovernmental Panel on Climate Change*. Stockholm.

Jefferson, M. (2008). Accelerating the transition to sustainable energy systems. *Energy Policy* , 36, 4116– 4125.

Kanoh, T. (2006). Nuclear energy—An essential option for sustainable development of global economy. *Nuclear Engineering and Design* , 236, 1455–1459.

Kaygusuz, A. & Kaygusuz, K. (2002). Renewable energy and sustainable development in Turkey. *Renew Energy* , 25, 431–53.

Kaygusuz, K. (2003). Energy policy and climate change in Turkey. *Energy Conversion and Management* , 44, 1671–1688.

Ke, M., Qi, L. & Qi, Z. (2011). A preliminary study on renewable energy's using mode of Tibet residential buildings. *International Conference on Materials for Renewable Energy & Environment ICMREE* (pp. 2058-2061). China: IEEE Conference Publications.

Lang LaSalle, J. (2010). *From sandbag to solar panels*. Report on Future-Proofing, London.

Langlois, L. & Vera, I. (2007). Energy indicators for sustainable development. *Energy* , 32, 875-82.

Leo Samuel, D. G., Maiya, M. P. & Shiva Nagendra, S. M. (2013). Passive alternatives to mechanical air conditioning of building: A review. *Building and Environment* , 66, 54-64.

Lew, D., Oliver, T., Priyjanonda, C. & Redlinger, R. (2001). Global energy efficiency and renewable energy policy options and initiatives. *Energy for Sustainable Development* , V (2), 15-25.

Lior, N. (2010). Sustainable energy development: the present (2009) situation and possible paths to the future. *Journal of Energy* , 35 (10), 3976–3994.

Özay, N. (2005). A comparative study of climatically responsive house design at various periods of Northern Cyprus architecture. *Building and Environment* , 40, 841-852.

Palz, W. & Starr, M. R. (1983). *Photovoltaic Power for Europe*. Dordrecht, Netherlands: D. Reidel Publishing Company.

Pank, W., Girardet, H. & Cox, G. (2002). *Tall buildings and sustainability: Report*. London, UK: Corp. of London.

Parent, J. (2012, October 26). Retrieved December 28, 2013, from Timelines: Jesse Parent's Blog: <http://jesseparent.wordpress.com/2012/10/26/qa-will-the-shale-gas-boom-inhibit-renewable-energy-development-in-the-us/>

(1985). *Photovoltaics Technical Information Guide*. Technical Information Branch of the. Washington, D.C.: U.S.: Government Printing.

Radically Sustainable Buildings. (2013). Retrieved January 2, 2014, from <http://earthship.com/>

Randall, T. & Fordham, M. (Eds.). (2006). *Environmental Design; An introduction for architects and engineers* (3rd ed.). London and New York: Taylor & Francis.

Saxon, R. (1994). *The atrium comes of age*. London: Longman Group UK Ltd.

Scott, A. (Ed.). (1998). *Dimensions of sustainability*. New York, USA: E & FN Spon.

Slessor, C. (2001). *Eco-Tech; Sustainable Architecture and High Technology*. Thames and Hudson.

Smith, P. F. (1988). *Architecture in a climate of change: A guide to sustainable design, Oxford*. Amsterdam, Boston, London, New York, Paris, San Francisco, Singapore, Sydney, Tokyo: Architectural Press.

Starr, C. (2005). *Biology: Concepts and Applications*. California, US: Thomson Brooks/Cole.

Steel, J. (1997). *Architecture today*. London: Phaidon Press.

Strong, S. J. (1987). *The Solar Electric House*. Emmaus, Pennsylvania: Rodale Press.

Talbott, J. (1997). *Simply build green; A technical guide to the ecological houses at the Findhorn Foundation*. Malta: Findhorn Press.

Tan, M. (1997). Opposite sunspaces passive solar air heating system. *Solar Energy*, 60, 127–34.

Thomas, R. (2006). *Environmental design: An introduction for architects and engineers* (3rd ed.). London & New York: Taylor & Francis Group.

Tsui, E. (1999). *Evolutionary Architecture; Nature as a Basis for Design*. New York.

United Nations Environment Programme. (2007, November). Retrieved November 17, 2012, from <http://www.unep.org>

URL1. (2012). *A review of climate change, mitigation and adaptation*. Retrieved June 23, 2012, from www.deepdyve.com/lp/elsevier/a-review-of-climate-change-mitigation-and-ad

URL2. (2013, December 1). Retrieved December 27, 2013, from BP energy statistics: the world in oil consumption, reserves and energy production: http://www.theguardian.com/news/datablog/2010/jun/09/bp-energy-statistics-consumption-reserves-energy#_

URL3. (2013, December 29). *Sun Earth Tools*. Retrieved December 29, 2013, from http://www.sunearthtools.com/dp/tools/pos_sun.php

URL4. (2013, December 11). *home power*. Retrieved from <http://www.homepower.com/articles/home-efficiency/design-construction/passive-solar-retrofit>

URL5. (2007, October 26). *Frankfurt am Main bei Nacht Commerzbank Tower*. Retrieved 2013, from <http://www.shortpics.de/reise/frankfurt.html>

URL6. (2014). *Commerzbank*. Retrieved March 14, 2014, from Commerzbank AG: https://www.commerzbank.de/en/hauptnavigation/presse/mediathek/bilddaten/buildings/buildings_1.html

Van der Ryn, S., & Calthorpe, P. (1991). *Sustainable communities; A new design synthesis for cities, suburbs and towns*. San Francisco: Sierra Club Books.

Volker, F. & Horst, G. (1997). *Sir Norman Foster and Partners: Commerzbank, Frankfurt Am Main*. Stuttgart: Druck und Bindearbeitenanstalt.

Warren, R. (1998). *The urban oasis; Guideways and green ways in the human environment*. New York: McGraw-Hill.

WCED. (1987). *Our Common Future, Report of the World Commission on Environment, The Brundtland Commission*. OxfordUniversityPress.

WEA. (2000). World Energy Assessment. *Energy and the Challenge of Sustainability, UNDP*.

Wines, J. (2000). *Green architecture*. (C. Keller, & N. Senger, Eds.) Italy: Benedikt Taschen Verlag GmbH.

Yeang, K. (1994). *Bioclimatic skyscrapers*. London: Ellipsis.

Yeang, K. (1995). *Designing with nature; The ecological basis for architectural design*. New York, US: McGraw-Hill.

Yeang, K. (2011). *Eco Skyscrapers: Volume 2*. (B. Lucy, Ed.) Victoria, Australia: The Images Publishing Group Pty Ltd.

Yeang, K. (1999). *The green skyscraper; The basis for designing sustainable intensive buildings*. Munich, Germany: Prestel Verlag.

Yeang, K. (1996). *The skyscraper bioclimatically considered*. (J. Wiley, Ed.) Chichester, UK: Wiley-Academy.

Zero Energy Design. (2010). Retrieved 1 2, 2014, from Abundant Energy in Harmony with Nature: <http://www.zeroenergydesign.com/>