

# **Introducing a Novel Hybrid Artificial Intelligence Algorithm to Optimize Network of Industrial Applications in Modern Manufacturing**

**Aydin Azizi**

Submitted to the  
Institute of Graduate Studies and Research  
in partial fulfillment of the requirements for the degree of

Doctor of Philosophy  
in  
Mechanical Engineering

Eastern Mediterranean University  
December 2016  
Gazimağusa, North Cyprus

Approval of the Institute of Graduate Studies and Research

---

Prof. Dr. Mustafa Tümer  
Director

I certify that this thesis satisfies the requirements as a thesis for the degree of Doctor of Philosophy in Mechanical Engineering.

---

Assoc. Prof. Dr. Hasan Hacısevki  
Chair, Department of Mechanical Engineering

We certify that we have read this thesis and that in our opinion it is fully adequate in Scope and quality as a thesis for the degree of Doctor of Philosophy in Mechanical Engineering.

---

Prof. Dr. Majid Hashemipour  
Supervisor

---

Examining Committee

1. Prof. Dr. Rashad Aliyev

---

2. Prof. Dr. Murat Bengisu

---

3. Prof. Dr. Mine Demirsoy

---

4. Prof. Dr. Majid Hashemipour

---

5. Assoc.Prof. Dr. Qasim Zeeshan

---

## **ABSTRACT**

Recent advances in technology and modern manufacturing industry have created a great need to model the behavior of manufacturing systems. Nowadays this need with the developments in computer technology and software engineering can be addressed by modern computational techniques. Artificial intelligence (AI) is one of the well-known advanced computational techniques which is growing fast, and have been utilized to model, control and optimize different disciplines of engineering, which manufacturing industry is no exception.

Obtaining real time information has a great value in different fields of manufacturing industry such as flexible manufacturing systems, inventory management and supply chain management. One of the developing technology which has been utilized to identify and track parts and objects in manufacturing industry is Radio Frequency Identification (RFID) system. An RFID system has been made of three major components namely tags which mounted at the parts needed to be track, antenna to read tags and computer as a middle ware.

Several challenges have been resulted due to adopting RFID in manufacturing industry environment. One of these challenges which has been research area of many scientists is known as RFID Network Planning (RNP) problem. Mainly RNP deals with calculating number of antennas which should be deployed in the RFID network to achieve full coverage of the tags which are needed to be read. A number of different optimization techniques have been used to optimize RNP, but many of them are complex and inefficient. The ultimate goal of this thesis is to present and evaluate

a way of modelling and optimizing nonlinear RNP problem utilizing artificial intelligence techniques. The research developed uses Artificial Neural Network models (ANN) to bind together the computational artificial intelligence algorithm with knowledge representation an efficient artificial intelligence paradigm to model and optimize RFID networks.

This effort has led to proposing a novel artificial intelligence algorithm which has been named hybrid artificial intelligence optimization technique to perform optimization of RNP as a hard learning problem. This hybrid optimization technique has been made of two different optimization phases. First phase is optimizing RNP by Redundant Antenna Elimination (RAE) algorithm and the second phase which completes RNP optimization process is Ring Probabilistic Logic Neural Networks (RPLNN).

The proposed hybrid paradigm has been explored using a flexible manufacturing system (FMS) located in Eastern Mediterranean University laboratory (EMU- CIM lab) and the results are compared with well-known evolutionary optimization technique namely Genetic Algorithm (GA) to demonstrate the feasibility of the proposed architecture successfully.

**Keywords:** Manufacturing Industry; Flexible Manufacturing system (FMS); Radio Frequency Identification (RFID); RFID Network Planning (RNP); Artificial Intelligence; Artificial Neural Networks (ANN); Hybrid Artificial Intelligence Algorithm; Redundant Antenna Elimination (RAE); Probabilistic Logic Neural Networks (RPLNN); Genetic Algorithm (GA)

## ÖZ

Teknoloji ve modern üretim sektöründe ki son gelişmeler üretim sistemlerinin davranışını modellemek için büyük bir ihtiyaç yarattık. Günümüzde bilgisayar teknolojisi ve yazılım mühendisliği gelişmeler bu ihtiyacı modern hesaplama teknikleri ile ele almaktadır.

Gerçek zamanlı bilgi edinme gibi esnek üretim sistemlerinin, envanter yönetimi ve tedarik zinciri yönetimi gibi imalat sanayinin farklı alanlarında büyük bir değeri vardır. Gelişen teknoloji biri Radyo Frekansı ile Tanımlama (RFID) sistemi imalat sanayi parçaları ve nesnelere tanımlamak ve izlemek için kullanılmıştır. Bir RFID sistemi, uç ana bileşenden (etiket, anten, bilgisayar) biri olarak kullanılmıştır.

RFID'nin imalat sanayinde kullanımı çeşitli zorluklar yaratmıştır. Bu zorluklardan biri RFID Ağ Planlama (RNP) sorunu olarak bilinir. RNP tam kapsama sağlamak için bulunması gereken anten sayısını hesaplar. RNP optimize etmek için farklı optimizasyon teknikleri kullanılır, ancak çoğu karmaşık ve verimsizdir. Bu tezin amacı modelleme ve yapay zeka teknikleri kullanarak doğrusal olmayan RNP problemini optimize etmektir. Burada geliştirilen araştırma Yapay Sinir Ağı modelleri (ANN) bilgi gösterimi ile hesaplama yaparak yapay zeka algoritmasını modellemek ve RFID ağlarını optimize etmek için kullanılmıştır.

Bu çaba sert öğrenme problemi olarak RNP optimizasyonu gerçekleştirmek için hibrid yapay zeka optimizasyon tekniği seçildi yeni bir yapay zeka algoritması öneren yol açmıştır. Bu melez optimizasyon tekniği iki farklı optimizasyon aşamadan yapılmıştır. İlk aşama Yedek Anten Eliminasyon (RAE) algoritması ve RNP

optimizasyon işlemini tamamlar ikinci faz RNP optimize ediyor Halka Probabilistik Mantık Sinir Ağları (RPLNN) 'dir.

iyi bilinen evrimsel optimizasyon teknikleri ile önerilen melez paradigma Doğu Akdeniz Üniversitesi laboratuvarında (EPB CIM lab) bulunan bir esnek üretim sistemi (FMS) kullanılarak araştırılmıştır ve sonuçlar karşılaştırılmıştır yani Genetik Algoritma (GA) başarıyla önerilen mimarinin uygulanabilirliğini göstermek için.

**Anahtar Kelimeler:** Üretim endüstrisi; Esnek İmalat sistemi (FMS); Radyo Frekansı Tanımlama (RFID); RFID Şebeke Planlaması (RNP); Yapay zeka; Yapay Sinir Ağları (ANN); Hibrid Yapay Zeka Algoritması; Yedekli Anten Yok edilmesi (RAE); Olasılıksal Mantıksal Sinir Ağı (RPLNN); Genetik Algoritma (GA)

## **To My Family**

## ACKNOWLEDGMENT

Firstly, I would like to express my sincere gratitude to my advisor Prof. Dr. Majid Hashemipour for the continuous support of my Ph.D study and related research, for his patience, motivation, and immense knowledge. His guidance helped me in all the time of research and writing of this thesis. I could not have imagined having a better advisor and mentor for my Ph.D study.

My sincere thanks also goes to Dr. Reza Vatankhah Barenji, Mr. Ali Vatankhah Barenji, Mr. Kevin Wang and Mr. Poorya Ghafoorpoor. Without their precious support it would not be possible to conduct this research.

I am grateful for the love, encouragement, and tolerance of my parents, who have made all the difference in my life. This journey would not have been possible without their support, patience and sacrifice. A special word of thanks also goes to my best friend and my life partner; my dear wife; for her continuous love, support and encouragement.

Finally, I would like to dedicate this thesis to my grandparents. I have been extremely fortunate in my life to have grandparents who have shown me unconditional love and support. The relationships and bonds that I have with my grandparents hold an enormous amount of meaning to me. I admire them for all of their accomplishments in life, for their independence, for their hierarchical role in our family, and for all of the knowledge and wisdom that they have passed on to their grandchildren over the years. Personally, my grandparents have played an important role in the development of my identity and shaping the individual that I am today.



They have taught me a great deal about the aging process and about growing old gracefully. It is because of them and their aging needs that I chose to pursue a professional career in Gerontology.

# TABLE OF CONTENTS

ABSTRACT.....	iii
ÖZ .....	v
ACKNOWLEDGMENT.....	viii
LIST OF FIGURES .....	xi
1 INTRODUCTION .....	1
1.1 Overview .....	1
1.2 Research Aims and Objectives.....	3
1.3 Research Methodology.....	5
1.4 Structure of thesis.....	7
2 MODERN MANUFACTURING .....	9
2.1 Internet of Thing.....	9
2.2 Radio Frequency Identification Technology.....	14
2.2.1 Introduction.....	14
2.2.2 Components of RFID System.....	16
3 RFID NETWORK PLANNING .....	21
3.1 Overview .....	21
3.2 Mathematical Modeling .....	23
3.2.1 Coverage.....	25
3.2.2 Redundant Antennas.....	27
3.2.4 Interference .....	28
3.2.5 Transmitted Power.....	28
4 HYBRID ARTIFICIAL INTELLIGENCE OPTIMIZATION TECHNIQUE...30	
4.1 Overview .....	30

4.2 Methodology .....	34
4.2.1 Redundant Antenna Elimination Algorithm.....	37
4.2.2 Ring Probabilistic Logic Neural Networks.....	41
4.3 Genetic Algorithm.....	57
5 IMPLEMENTATION .....	61
5.1 Overview .....	61
5.2 Working Area .....	61
5.2.1. Static Working Area .....	61
5.2.2 Dynamic Working Area.....	62
5.3 Parameters of the Proposed Hybrid Algorithm .....	64
5.3.1 Population of the Possible Answers .....	65
5.3.2 Fitness Function.....	66
5.4 Results .....	68
5.4.1 Static Working Area .....	68
5.4.2 Dynamic Working Area.....	72
5.5 Conclusion.....	76
REFERENCES .....	78

## LIST OF FIGURES

Figure 1: Proposed Methodology of optimizing RNP problem.....	5
Figure 2: Structure of this thesis .....	8
Figure 3: Defenition of Internet of Things [18 ] .....	9
Figure 4: Internet of Things: Intelligent Systems Framework [22 ] .....	10
Figure 5: IoT Model for Manufacturing and Industrial Automation [23].....	11
Figure 6: Connected Enterprise [25].....	12
Figure 7: Integrated equipment and appliances [26].....	13
Figure 8: The Digital Retail Store [28] .....	14
Figure 9: components of an RFID system [30].....	16
Figure 10: interactions between components of RFID system [30].....	17
Figure 11: RFID tag [17] .....	17
Figure 12: RFID tag with printed barcode on it [32] .....	18
Figure 12: RFID Active Tag [35] .....	18
Figure 12: RFID Passive Tag [37] .....	19
Figure 15: Components of RFID network [26].....	22
Figure 16: Steps of Defining a RNP .....	23
Figure 17: Working area and distributed 20 tags.....	24
Figure 18: Example of Tag coverage, if $\underline{PT_{a_1,t_n} \geq T_{t_n} \wedge PA_{t_n,a_3} \geq T_{a_3}}$ then Cv (1)=1.....	26
Figure 19: Proposed Hybrid optimization technique .....	32
Figure 20: RNP optimization process .....	33
Figure 21: Proposed Hybrid Artificial Intelligence optimization process .....	35
Figure 22 : Flowchart of the Proposed Redundant Antenna Elimination Algorithm .	40
Figure 23 : Biological Neuron [6].....	41

Figure 24 : Example of Artificial Neural Networks [21].....	42
Figure 25 : A RAM neuron [54] .....	44
Figure 26 : A RAM Discriminator [56] .....	45
Figure 27 : Flowchart of training algorithm of RAM Neural Network .....	47
Figure 28 : Probabilistic Logic Neuron (PLN) .....	48
Figure 29 : Pyramidal PLN Neural Network sttructure [ 59] .....	49
Figure 30 : Example of a PLN Neural Network sttructure [60].....	50
Figure 31 : RPLNN sttructure [63] .....	51
Figure 32 : Flowchart of the Proposed RPLNN algorithm to Optimize RNP .....	56
Figure 33: Example of Roulette Wheel.....	58
Figure 34: (a) two points Crossover, (b) single point crossover .....	59
Figure 35: Example of Mutation.....	60
Figure 36 : Proposed Static Working Area .....	62
Figure 37 : FMS laboratory of Eastern Mediterranean University (EMU) .....	63
Figure 38 : Proposed Dynamic Working Area.....	63
Figure 39 : Proposed Population of Possible Answers .....	66
Figure 40: Example of Encoded answer in Population of Answers .....	66
Figure 41: Calculated Number of Deployed Antennas in the Network by the Proposed Hybrid Algorithm and GA in Each Iteration.....	69
Figure 42: Calculated Coverage of the RFID Network by the Proposed Hybrid Algorithm and GA in Each Iteration.....	69
Figure 43: Calculated ITF of the Network by the Proposed Hybrid Algorithm and GA in Each Iteration .....	70
Figure 44: Normalized Fitness Functions Values of the Proposed Hybrid Algorithm and GA in Each Iteration .....	71

Figure 45: Optimized RFID Network .....	72
Figure 46: Calculated Number of Deployed Antennas in the Network by the Proposed Hybrid Algorithm and GA in Each Iteration.....	73
Figure 47: Calculated Coverage of the RFID Network by the Proposed Hybrid Algorithm and GA in Each Iteration.....	73
Figure 48: Calculated ITF of the Network by the Proposed Hybrid Algorithm and GA in Each Iteration .....	74
Figure 49: Normalized Fitness Functions Values of the Proposed Hybrid Algorithm and GA in Each Iteration .....	75
Figure 50: Optimized RFID Network .....	76

# Chapter 1

## INTRODUCTION

### 1.1 Overview

The steady state industry status has been changed to dynamic industry by the industrial revolution, so manufacturers have been pushed by the global market to reconsider their conventional manufacturing methods [1]. Modern manufacturing needs new manufacturing operations, and effective factory management has a great value in this area [ 2]. Recent advances in technology and modern industrial engineering systems from production to transportation have created a great need to track and identify the materials, products and even live subjects [3]. Radio Frequency Identification (RFID) technology is a reliable and efficient solution to this tracking and identifying problem. RFID technology is known as an automatic identification technology as it uses wireless radio frequency waves which are produced by an electromagnetic field to transfer data to track and identify objects. This technology can be implemented in different fields such as tracking and identifying patients in hospitals [4], warehouse items tracking [5], tracking pallets and cases in shipment [6], monitoring production line [7], supply chain management [8].

In many applications, the deployment of RFID systems has generated an RFID network planning (RNP) problem [9] which needs to be resolved, in order to efficiently operate a large-scale network. However, RNP is one of the most challenging problems that has to meet many requirements of the RFID system[10-11]. In general, the RNP aims to optimize a set of objectives (coverage, load balance,

economic efficiency and interference between antennas, etc.) simultaneously; this is achieved by adjusting the control variables (the coordinates of the readers, the number of antenna, etc.) of the system. As a result, in a large-scale deployment environment, the RNP problem is a high-dimensional nonlinear optimization problem that has a vast number of variables and uncertain parameters.

Tracking and identifying objects in these applications requires the deployment of several RFID antennas in the RNP, and the numbers of these antennas are calculated through the use of a mathematical model [10-12]. In the past, one of the typical way to address the RNP problem was using a trial and error approach, which was an inaccurate and inefficient solution for such an important issue [7], [13] and [14]. In addition, this approach could only be used on small-scale RFID network planning problems [10]. Nowadays with the developments in computer technology, and software engineering, the conventional trial and error approach has been replaced with modern computational techniques that provide such important criteria like coverage of objects, collision of antennas, and number of antenna [15]. Computational evolutionary techniques such as Artificial Neural Networks [16], Fuzzy Logic [17], Genetic Algorithms (GA) [10], [11] and [18], particle swarm optimization (PSO) [13], [19] and [20], differential evolution (DE) [9], and hierarchical artificial bee colony algorithm [8], are points of interest for many scientists working with the RNP problem. In this respect, Han et al [21] proposed a novel optimization algorithm namely the multi community GA- PSO for solving the complicated RNP problem. Hannin et al [7] developed an optimization model for planning the positions of the readers in the RNP based on PS2O. Azli et al [22] proposed solution based on the PSO correlation between RNP parameters. Shilei et al [23] proposed an approach based on k-coverage for RFID network planning; a k-



coverage model is formulated from a multi-dimensional optimization problem and plant growth simulation algorithm; this is used to optimize the RFID networks by determining the optimal adjustable parameters. Yue et al [13] used the PSO algorithm with redundant reader elimination for optimizing the RNP.

The aim of this thesis is to present and evaluate a novel way of optimizing nonlinear RNP problems utilizing artificial intelligence techniques. The research developed uses Artificial Neural Network models (ANN) to bind together the computational artificial intelligence algorithm with knowledge representation an efficient artificial intelligence paradigm to optimize nonlinear RNP problems. Starting from introducing of existing artificial neural networks models, it defines which structure are required in order to optimize functions. Different artificial intelligence algorithms, which can satisfy the required capabilities for optimizing of defined RFID network planning problem which can be represented as mathematical models, are presented and discussed. This effort has led to proposing a novel artificial intelligence algorithm which has been named hybrid artificial intelligence optimization technique to perform optimization of RNP as a hard learning problem. The proposed hybrid optimization technique has been made of two different optimization phases. First phase is optimizing RNP by Redundant Antenna Elimination (RAE) algorithm and the second phase which completes RNP optimization process is Ring Probabilistic Logic Neural Networks (RPLNN).

## **1.2 Research Aims and Objectives**

The objective of this thesis is to present and evaluate a novel way of optimizing RNP problem as an important part of manufacturing industry utilizing artificial intelligence techniques. The research developed uses Artificial Neural Network

models (ANN) to bind together the computational artificial intelligence algorithm with knowledge representation an efficient artificial intelligence paradigm to optimize deployed number of antennas in RFID network based on the criteria of defined RNP as a nonlinear engineering problem.

Starting from defining of radio frequency identification systems, it defines challenges of establishing an efficient RFID network and introduces existing RNP models, it will be followed by introducing the existing artificial neural networks models, it defines which structure are required in order to optimize nonlinear RNP functions. Different artificial intelligence algorithms, which can satisfy the required capabilities for optimizing of defined RNP problems which can be represented as mathematical models, are presented and discussed. This effort has led to the utilizing of a novel artificial intelligence algorithm which is named hybrid artificial intelligence optimization technique to perform optimization of RNP as a hard learning problem. The proposed hybrid optimization technique has been made of two different optimization phases. First phase is optimizing RNP by Redundant Antenna Elimination (RAE) algorithm and the second phase which completes RNP optimization process is Ring Probabilistic Logic Neural Networks (RPLNN).

The ultimate goal of this research is to introduce Ring Probabilistic Logic Neuron as a time efficient and reliable optimization technique to solving RFID network planning problem and design a cost effective RFID network by minimizing number of embedded RFID antennas in the network, minimizing collision of antennas and maximizing coverage area of objects.

The proposed hybrid artificial intelligence paradigm has been explored using a flexible manufacturing system (FMS) located in Eastern Mediterranean University laboratory (EMU- CIM lab) and the results are compared with two different optimization technique namely Genetic Algorithm (GA) to demonstrate the feasibility of the proposed architecture successfully.

### 1.3 Research Methodology

The proposed methodology of this thesis contains three phases namely problem identification, research & development and implementation (see Figure 1).

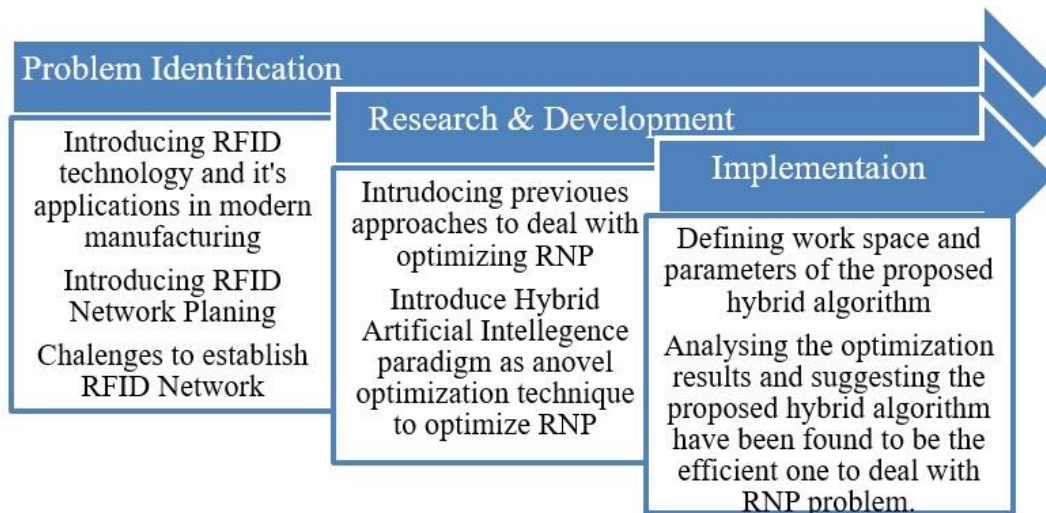

Figure 1: Proposed Methodology of optimizing RNP problem.

The main contributions of this thesis in detail are as follows:

#### 1. Problem Identification

- i) Introducing RFID systems as application have been used in manufacturing industry.
- ii) Sufficiently reviews the previous work on RFID network planning

iii) Identifying the existing challenges to establish an efficient RFID network

2. Research & Development:

i) Sufficiently reviews the previous work on for optimizing RNP.

(1) Introduces Artificial Neural Network as computational intelligent technique in detail to deal with RNP, including certain extensions and applications.

(2) Investigate and introduce different Artificial Neural Networks models.

ii) Proposes hybrid artificial intelligence as novel technique to deal with optimizing RNP.

(1) Introduces Redundant Antenna Elimination (RAE) algorithm as the first part of proposed hybrid algorithm.

(2) Introduces Ring Probabilistic Logic Neural Networks (RPLNN) as the second part of the proposed hybrid algorithm

3. Implementation:

i) Defines the working area of RNP.

ii) Implements proposed technique in flexible manufacturing system (FMS) located in Eastern Mediterranean University laboratory (EMU- CIM lab)

iii) Comparative analysis performance of the proposed algorithm with Genetic Algorithm and Particle Swarm as two powerful evolutionary techniques.

iv) Explains some current difficulties and problems based on the summary and conclusion of the thesis, and proposes future solutions.

## **1.4 Structure of thesis**

The rest of this research is organized as following: Chapter 2 is an introduction of modern manufacturing and Internet of thing technology and it's applications beside of introducing radio frequency identification systems as one of the important adopted technology by internet of thing. Chapter 3 is an introduction to RFID network planning and introducing recent mathematical models of RFID network planning. RNP Optimization techniques will be reviewed in chapter 4 as well as proposing a novel artificial intelligent hybrid algorithm to deal with RNP, the proposed hybrid algorithm and two has been implemented on FMS located in EMU in order to optimize RNP in chapter 5 and results have been discussed and it is followed by conclusion and summary.

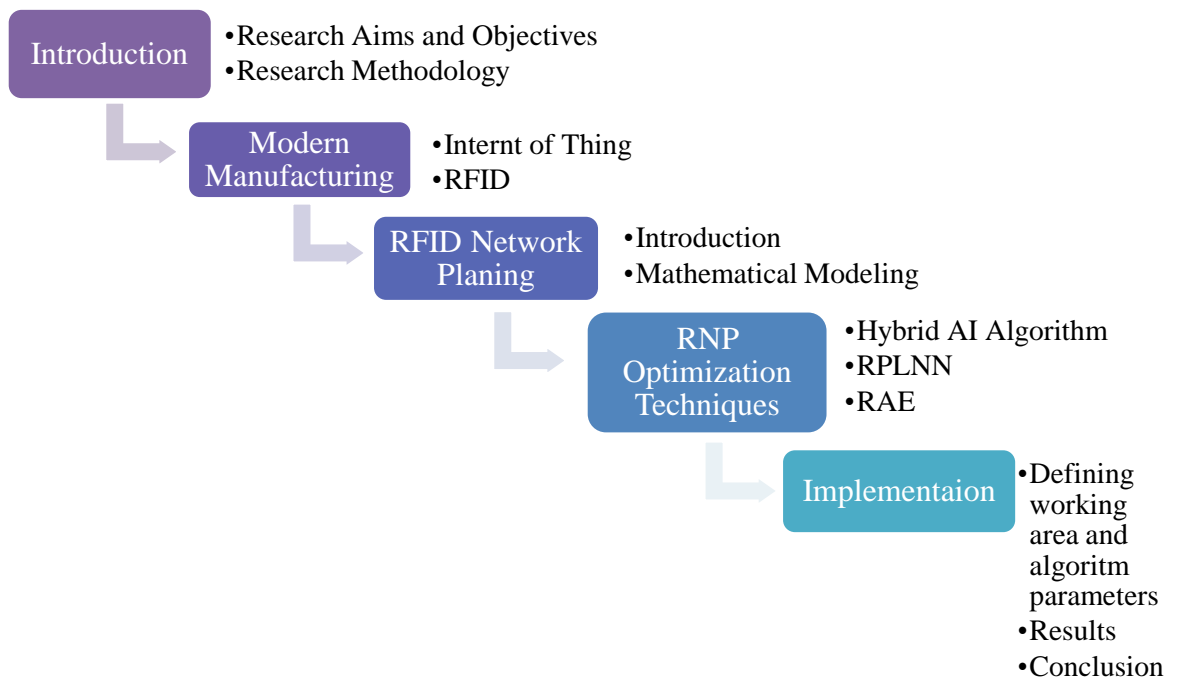

Figure 2: Structure of this thesis

## Chapter 2

# MODERN MANUFACTURING

### 2.1 Internet of Thing

The steady state industry status has been changed by the industrial revolution to dynamic industry, so manufacturers have been pushed by the global market to reconsider their conventional manufacturing methods [10]. Modern manufacturing needs new manufacturing operations, and effective factory management has a great value in this area [15]. Smart manufacturing is a powerful concept which can be addressed as an answer to needs of modern manufacturing [16] by utilizing and adding high-tech products such as sensors, software and wireless connectivity to required products [17]. Overall utilizing high-tech equipment in manufacturing in order to optimize the manufacturing methods results in exploring a new concept which is known as Internet of Things (IoT) [18].

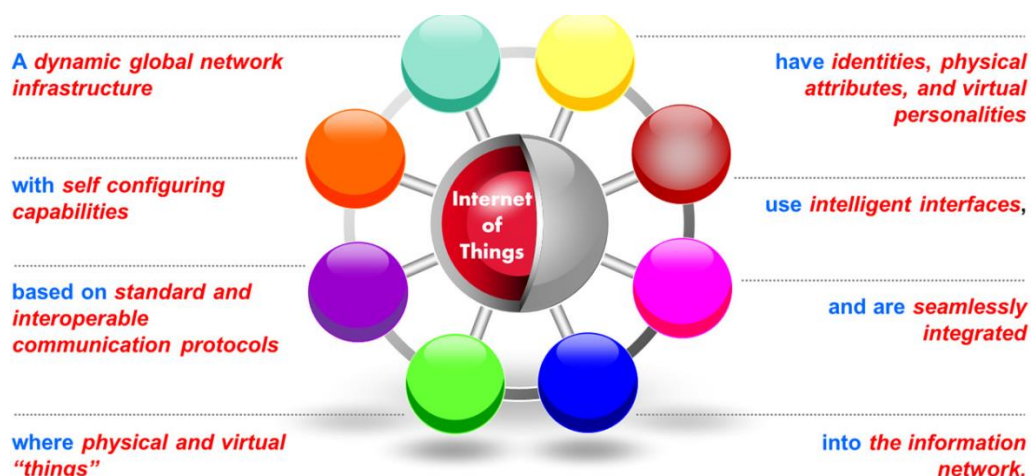

Figure 3: Defenition of Internet of Things [18]

The Internet of Things (IoT) can be defined as interaction between technologies which includes smart objects, machine to machine communication, radio frequency technologies, and a central hub of information to monitor the status of physical objects, capturing meaningful data, and communicating that information through IP networks to software applications [19].

In IoT to make objects detectable in order to monitor and collect required data from them they are equipped with an Auto- ID technology [20]. Utilizing this technology enable users to analyze the collected data which can be contain the information such as temperature, changes in quantity, or other types of information through wireless communication and make efficient and accurate decisions [21].

In recent years with advances in technology IoT has started to adopt and utilize a new technology which is named Radio Frequency Identification (RFID), continuously increases its market share, replacing traditional barcode technology and allows for the development of new applications [22].

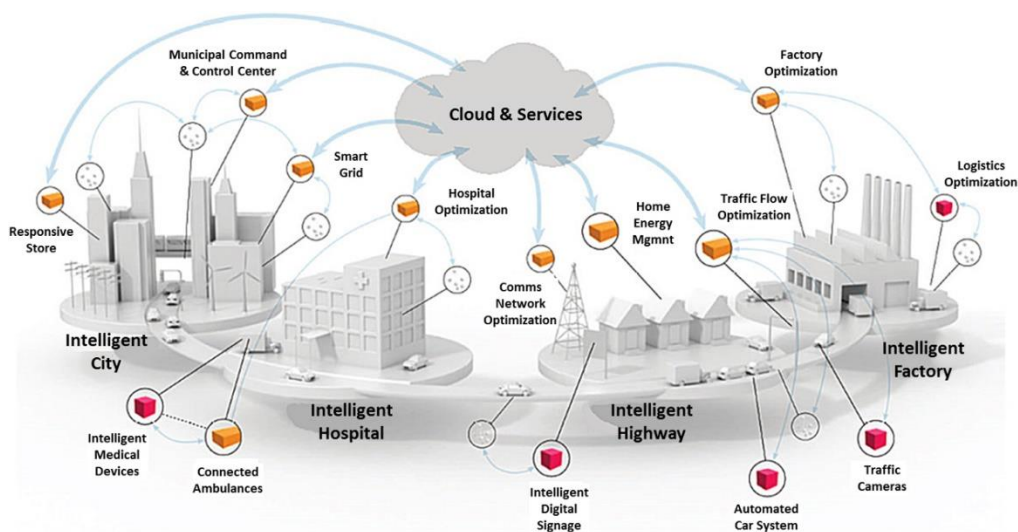

Figure 4: Internet of Things: Intelligent Systems Framework [22]



RFID technology can be defined as a powerful innovative gadget which has been adopted in development of IoT [21]. RFID technology as an application in IoT with accepted standards across industries widely has been adopted in different manufacturing industry section, we are representing some of the most important examples as below:

- Supply Chain Management:

Employing RFID systems as an IoT application has a great importance in supply chain management as a valuable part of modern manufacturing and industrial automation. With the aid of using RFID system managers will be able to track, monitor and control their products in real time from the status of being as raw material to rotation as final products in shelves and warehouses. They will have all required data related shipments, location, temperature, pressure and even days until expiration [23].

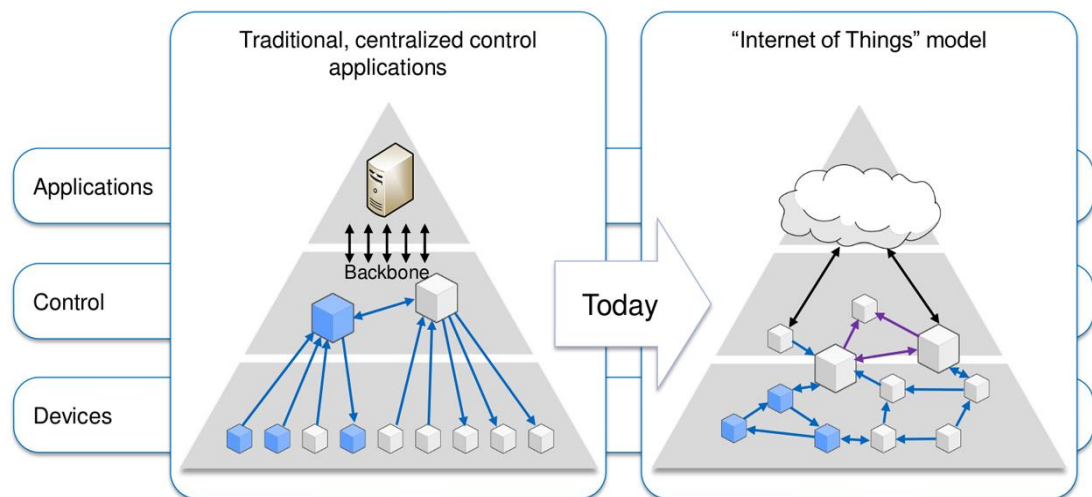

Figure 5: IoT Model for Manufacturing and Industrial Automation [23]

- Smart Manufacturing

A smart and efficient manufacturing can be achieved by utilizing IoT which will connect the factory to applications run around the production. In other hand it can be said that in smart manufacturing manufacturer is enabled to include suppliers, production logistics and even maintenance [24]. This means that the services Of IoT-enabled manufacturing system will be in a shared physical world rather than restricted in a physical system.

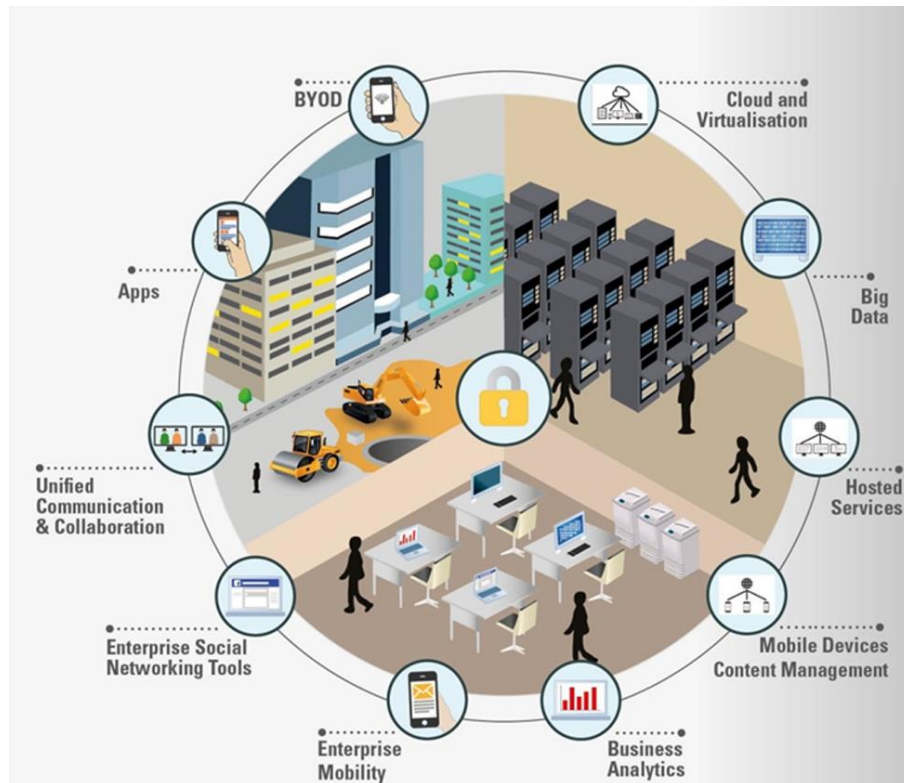

Figure 6: Connected Enterprise [25]

- Home Automation Industry

Nowadays Home automation industry by adopting RFID in IoT is closer to its goal which is interconnected home application. Utilizing RFID technology to enable home residents using a remote device to control all home electronic devices and appliances has been point of research of many organizations. This concept has been introduced by smart products such as smart air conditioners, smart thermostats and etc. which can be monitored and controlled from distance just by an application of a smart phone [26].

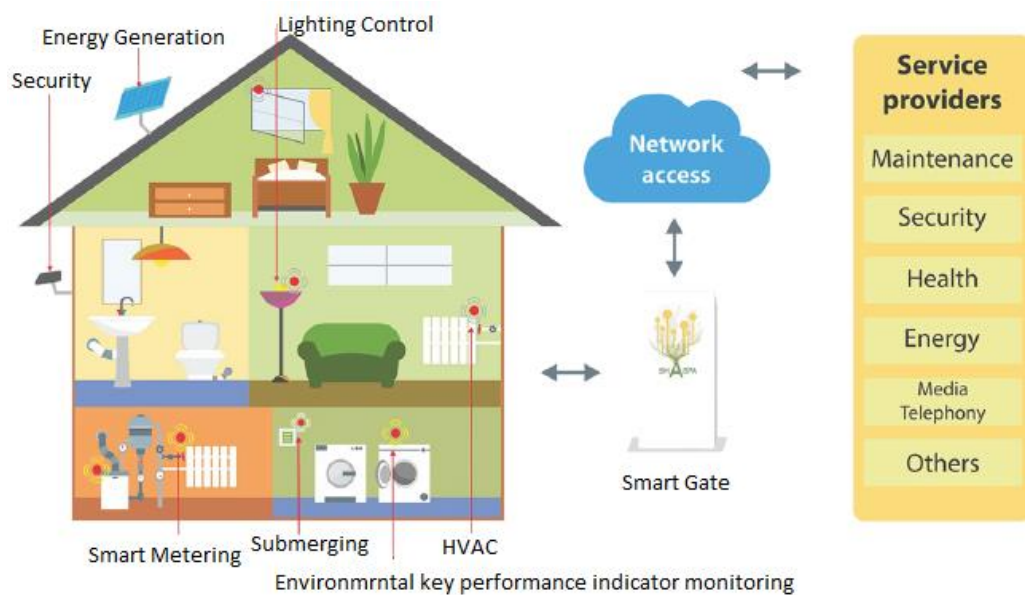

Figure 7: Integrated equipment and appliances [26]

- Intelligent Shopping

People in term of consumers can manage their time daily life in more efficient way and also they can have save money by utilizing RFID technology as an application of Internet of Things application. A real time grocery list can be generated automatically for consumers and list the items will be consumed or expired in near future date. So it prevents people to buy the items which are not necessary and it will

results in reducing the waste [27]. Also utilizing RFID as an IoT application by retailers will enable them to collect real time data from their inventory, resources, products and etc. to have a better overview of their chain of customers, employees.



Figure 8: The Digital Retail Store [28]

After giving a brief review about the Internet of Things as an important part of manufacturing industry, and introducing Radio Frequency Identification technology as a powerful gadget and application in IoT in the next sections of this chapter RFID technology and it's components have been be introduced in detail and establishment of an RFID network will be discussed.

## 2.2 Radio Frequency Identification Technology

### 2.2.1 Introduction

Obtaining real time information has a great value in different fields of manufacturing industry such as flexible manufacturing systems, inventory management and supply chain management. Recent advances in technology and modern industrial engineering systems from production to transportation have created a great need to

track and identify the materials, products and even live subjects [1]. One of the developing technologies which has been utilized as an application in Internet of Thing (IoT) to identify and track parts and objects in manufacturing industry is Radio Frequency Identification (RFID).

Radio Frequency Identification (RFID) technology is an Auto- ID technology which is adopted by IoT as a reliable and efficient solution to problem of object tracking and identifying. RFID technology is known as an automatic identification technology as it uses wireless radio frequency waves which are produced by an electromagnetic field to transfer data to track and identify objects. Utilizing this technology enable users to analyze the collected data which can be contain information of the objects such as temperature, changes in quantity, or other types of information through wireless communication and make efficient and accurate decisions [7].

It can be said that modern manufacturing has been changed by impact of utilizing Radio Frequency Identification [10]. These changes have widely range and includes but not limited to: the manner of the tracking objects not even in small and medium enterprises also the boundaries of tracking of the objects upgraded to global scale [22] and interaction of products with production environment.

In past barcode technology had been used to track and identify objects and items in different manufacturing fields, however utilizing this applications was cheap but it should mentioned that since collecting data had been done manually by a barcode reader so it was not was not an easy and efficient task [17]. The other important drawback of using barcode is the nature of storing the information of the object just in the time of reading, so barcodes do not provide manufacturer required data in real

time and they are capable of recording data just in time [27], so it makes not effective technology in modern manufacturing. Nowadays this technology has been replaced with RFID technology and has been used as an effective application in industries and it has been in point of research interest of many researchers. Gupta et al [28] investigated RFID importance in production and operation management. Irani et al [29] proposed framework for presenting research obstacles related to RFID technology. A comprehensive research about transferring real time information using RFID technology in value adding chain component has been given by Chen et al [30]. In general This technology can be implemented in different fields such as tracking and identifying patients in hospitals [8], warehouse items tracking [3], tracking pallets and cases in shipment [4], monitoring production line [5], supply chain management [6].

### 2.2.2 Components of RFID System

An RFID system is made up of two major parts: Hardware part and Software part. Hardware part consists of tags, readers, antennas and software part includes middleware which can be defined also as computer unit [30]. It should be noted that the antenna can be a part of the reader, meaning more than one antenna can be connected to one reader.



Figure 9: components of an RFID system [30]

RFID is the advanced technology in data process. Required data from objects are sent by tags to readers, antennas of readers receive these data and send to a host computer as middleware to process for further implementations. (see Figure 10).

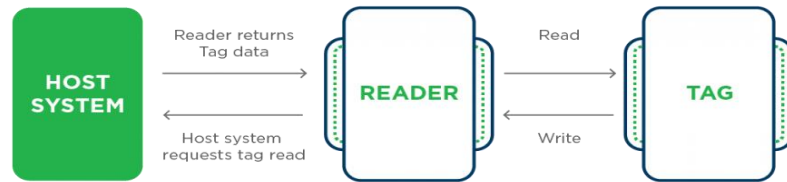

Figure 10: interactions between components of RFID system [30]

## RFID TAGS

One of the major parts of RFID system is tag. All the object data are send by tags to readers, it should be mentioned that tags are made up from microchips which are attached to antennas and data are send by these antennas in form of electromagnetic waves which are known as RF signals ( see figure 11) [17].

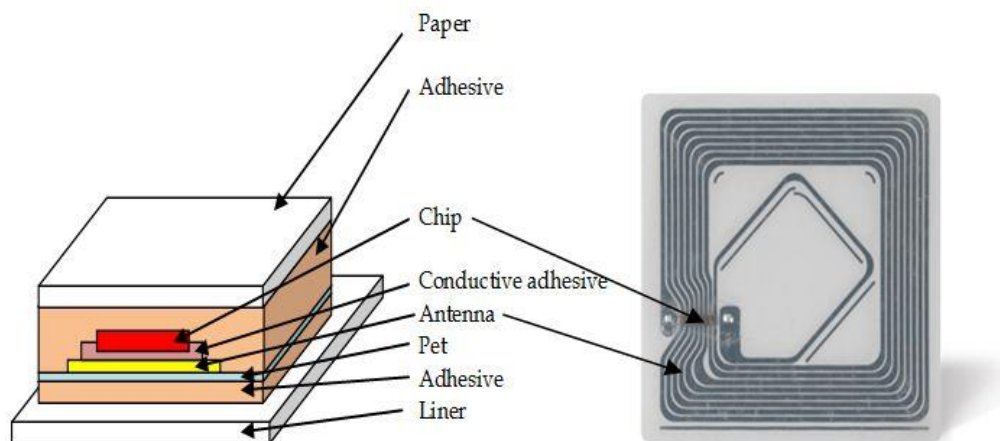

Figure 11: RFID tag [17]

RFID tags have different shapes, we can see some of them in daily life in stores and markets as smart labels which include printed barcode on them (see figure 12), in the form of simple tags which are mounted inside a carton , smart cards[32].

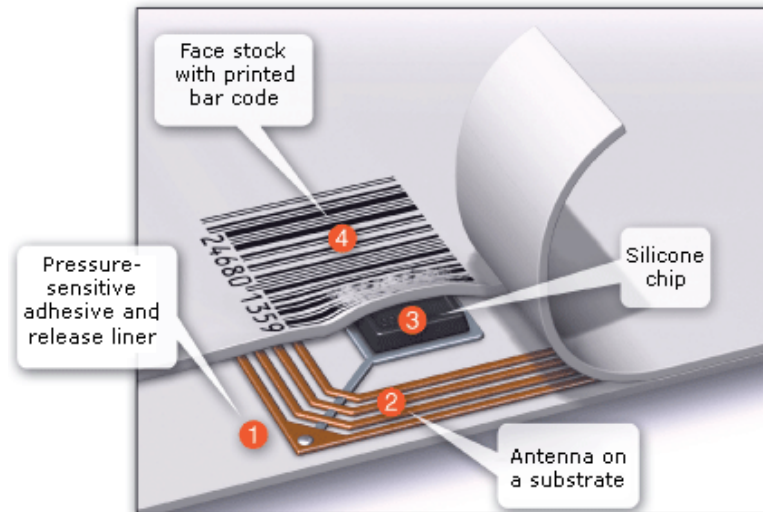

Figure 12: RFID tag with printed barcode on it [32]

In general RFID tags are divided to three major groups which are namely known as Passive Tags, Semi Passive and Active Tags [32].

a) Active Tags

Active tags have their own power source, so they can send and broadcast their own signals [33]. This source of energy can be a battery, PV cells or other sources [34]. From point of view of the range of broadcasting active tags have longer range than passive tags because they have their own source of energy to broadcast [35].



Figure 13: RFID Active Tag [35]



b) Passive Tags and Semi Passive Tags:

Passive tags do not have their own power source, so they cannot send and broadcast their own signals [36]. A passive tag receives signal which has been sent by a reader, this signal contains energy which can be absorbed by microchip circuit of passive tag, so from then passive tag enables to reflect the absorbed signal to reader. It should be mentioned that there is an energy loss due to this reflection and the resultant will be a lower read range of the passive tag [37].



Figure 14: RFID Passive Tag [37]

### **RFID Readers**

RFID readers are other major part of RFID system which have role of communication with RFID tags [38]. RFID readers make this communication by sending and receiving RF signals back from RFID tags through their antennas [39]. Antenna of RFID readers are divided to two types: internal antennas and external antennas [40].

RFID readers which have external antennas can be connected to several antennas, each connection is applicable through a port. It should be mentioned that readers with external antennas can be deployed with to eight antenna ports [41]. Readers can have different ports such as USB ports, Wi-Fi ports, serial ports and input/output ports to be connected with external devices [42].

### **RFID Antennas**

The antenna can be a part of tag or reader and can be defined as a conductive element which tags and readers can transmit and receive data through that [43]. The antennas can have different shape but all of them serves as one purpose which is transmitting of radio waves [44].

### **RFID Middleware**

RFID middleware can be defined as software part of the RFID system which can be inhabited on a server to filter collected data of RFID readers and may to pass on useful collected data to enterprise applications [45].

Some of the RFID middleware not only has function of filtering data, also is capable of managing and monitoring of RFID readers [46]. This kind of middleware configuring RFID readers and monitoring their functionality, additionally if it is needed the middleware sends necessary updates to update readers [47].

After giving introduction to modern manufacturing and RFID technology as an important applications which has been adopted in IoT as part of modern manufacturing, next chapter will introduce mathematical modeling of establishing an RFID network.

## Chapter 3

### RFID NETWORK PLANNING

#### 3.1 Overview

With advances in technology modern manufacturing industry is bounded with data inter-connectivity [48]. The key of the being successful in modern manufacturing industry is achieving to useful and in time data [49] which can be part of supply chain management tracking devices which are used to that track and map a live subject or parts or part of flexible manufacturing industry to give alerts to manufacturers in different regards to need for maintenance of parts [41]. Manufacturers to collect required data for further analyses deploying different types of gadgets of IoT [43] such as sensors, network cameras or most smart one RFID systems in their operational field [44].

An RFID system as discussed in chapter two of this thesis includes of four major elements: tags, readers, antennas and computer unit. It should be reminded that the antenna as internal antenna can be a part of the reader, or it can be mounted as external antenna, also each reader can adopt one or more than one antennas. Readers through antennas collect the data sent by tags and relay this to a host computer to process for further implementations. In essence, RFID is the technology of processing data which is radio frequency signals omitted from mounted tags on subjects and sent by readers to a host computer unit [24].

There are three types of tags: passive, semi-passive and active. Differences between these the difference is in their source of power where active and semi-passive tags are battery powered but passive tags don't have internal power [25]. It should be noted that in this thesis passive tags because of having advantages such as being cost efficient and having long life cycle over semi-passive and active tags have been adopted in RNP [26].

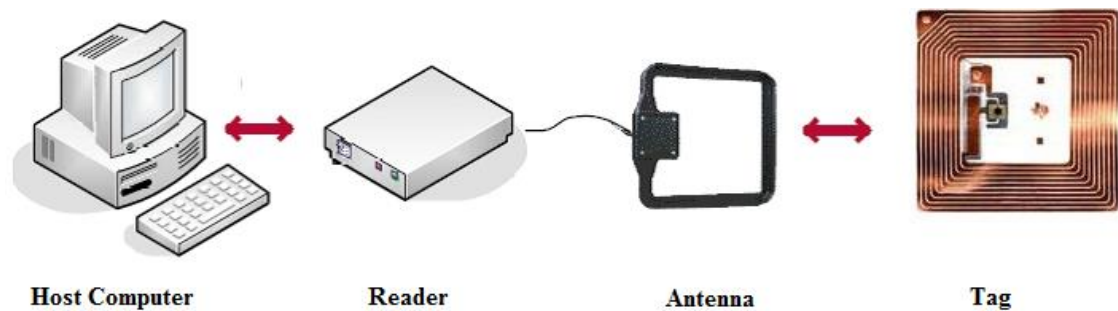

Figure 15: Components of RFID network [26]

Data of a tag can be read by a reader in certain distance between tag and antenna of reader. It means that a reader through its antenna can receive information of a tag in a limited range. The establishment of communication between antenna and tag is relies on distance between tag and antenna and highly sensitive in case of changing the distance [27]. So because of the distance problem there is a possibility of not being read data of tag by a reader which can be named as uncovered tag problem.

Utilizing more antennas is a common solution which is adopted in recent years to overcome to this problem [33]. By adopting more antennas in RFID system important criteria such as number of antennas and positions of them, collision of the antennas, and coverage of the network need to be calculated. Answering such

questions has led to an important concept known as RFID Network Planning (RNP) [13] and [23].

### 3.2 Mathematical Modeling

To model of RFID network mathematically some important criteria such as number of tags, number of antennas, coverage percentage of the network, collision percentage of antennas and transmitted power in the network should be considered in mathematical model. One of the reliable mathematical models which adopted by many researches to deal with RNP [13], [29] and [30] is The Friis transmission equation [28]. In this thesis a developed model of this equation which is proposed by Gong et al. [13] is utilized to deal with RNP.

To model a RFID network and have a RNP first step is defining the working area, the next step is defining number of tags which are needs to be read by readers and finally defining number of antennas of the readers (see figure 16).

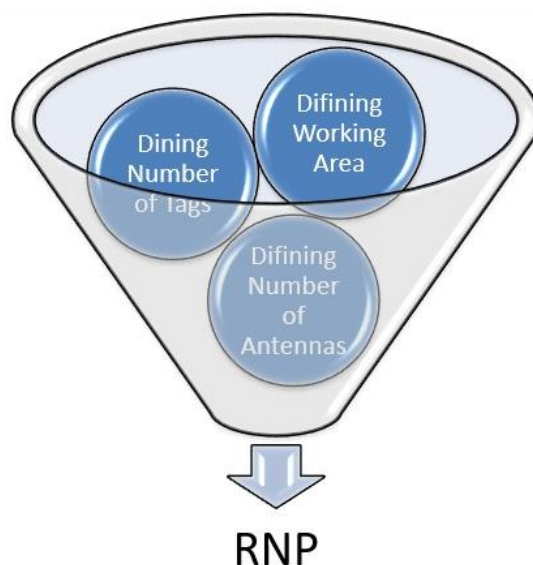

Figure 16: Steps of Defining a RNP

An example of RFID network plan is illustrated in figure 17 with following specifications:

- Working area: square room with dimension of  $100 \times 100 \text{ m}^2$
- RFID Tags: 20 passive tags which are randomly distributed in working area
- Antenna: 20 antennas which are randomly distributed in working area

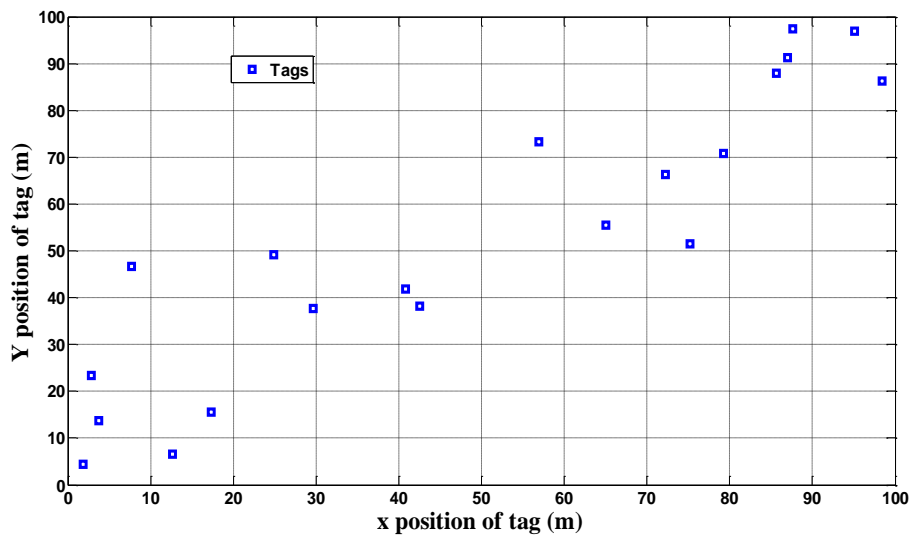

Figure 17: Working area and distributed 20 tags

After defining the RNP, the next step is defining and calculating parameters of the RNP such as coverage of the network, redundancy of the network, interference of the network and finally transmitted in the network.

### 3.2.1 Coverage

Coverage of the network is defined as the percentage of the tags which have been read by the readers via antennas of the readers and the most important criteria which should be satisfied in RNP is achieving 100% coverage of tags.

As mentioned before the distance between tag and antenna play a major role in tag coverage, also passive tags do not use power source for transmitting RF signals and they reflecting back the emitted power in by antennas of readers. This back transmission accrues when internal circuit of a passive tag has been powered up (activated) by a RF signal as an electromagnetic wave which has a greater power than threshold of the tag, since then the powered up tag starts to reflect back signal to antenna of a reader and if this signal has been received by an antenna so it can be said that communication between tag and reader through the antenna is established and that tag has been covered [31]. All this procedure can be summarized as following 3 steps [13]:

- 1) A tag receives a signal from an antenna with power of  $PT_{a,t}$  which is greater than the threshold value of power of the tag ( $T_t$ ).
- 2) This signal activates the tag, and the tag starts to send a backscatter signal to antennas with power of  $PA_{t,a}$ .
- 3) If the power of the backscatter signal is greater than the threshold value of the power of the antenna ( $T_a$ ) then it can be said that the tag is covered by the antenna.( see figure 18)

The mathematical model of above steps is defined as following [13]:

$$C_v(t) = \begin{cases} 1, & \text{if } \exists a_1, a_2 \in AS, PT_{a_1,t} \geq T_t \wedge PA_{t,a_2} \geq T_a \\ 0, & \text{otherwise} \end{cases} \quad (1)$$

The adopted formula for  $N$  tags is defined as below [13]:

$$COV = \sum_{t \in TS} \frac{C_v(t)}{N_t} \times 100\% \quad (2)$$

Which here  $N_t=20$  and  $1 \leq t \leq 20$

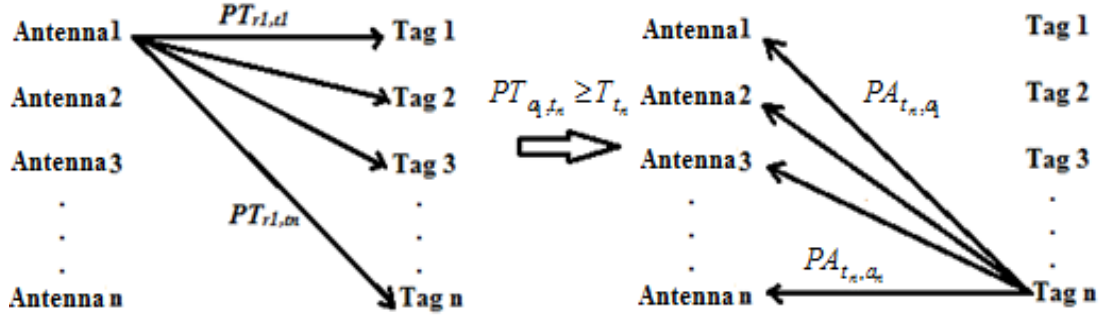

Figure 18: Example of Tag coverage, if  $PT_{a_1,t_n} \geq T_{t_n} \wedge PA_{t_n,a_3} \geq T_{a_3}$  then  $C_v(l)=1$

Received power by tags  $PT_{a,t}$  and Transmitted power by tags  $PA_{t,a}$  are calculated through Friis transmission equation as below [13]:

$$PT_{a,t}[dBm] = P_t[dBm] + G_a[dBi] + G_t[dBi] - L[dB] \quad (3)$$

$$L[dB] = 10 \log \left[ \left( \frac{4\pi}{\lambda} \right)^2 d^n \right] + \delta[dB] \quad (4)$$

$$PA_{t,a}[dBm] = P_t[dBm] + G_t[dBi] + G_a[dBi] - 20 \log \left( \frac{4\pi d}{\lambda} \right) \quad (5)$$



$$P_b = (\Gamma_{tag})^2 \times P_t \quad (6)$$

Where  $P_t$  is the transmitted power of the antenna,  $G_a$  is the gain of the antenna,  $G_t$  is the gain of the tag,  $L$  represent Loss,  $\lambda$  is the wavelength,  $d$  is the distance between tag and antenna,  $n$  depends on environment varies from 1.5 to 4;  $\delta$  represents other losses,  $P_b$  is the backscatter power transmitted by tag which is reduced by multiplying into the reflection coefficient  $\Gamma_{tag}$  [13].

### 3.2.2 Redundant Antennas

Redundant antenna can be defined as an antenna which by eliminating that antenna coverage of the network will remain as same as before elimination. Having redundant antenna in the network is not convenient since it means imposing more unnecessary extra cost to manufacturer, do it is an important criteria in RFID network planning to calculate the redundancy of the network and eliminate or reduce it. Following this procedure results in calculating number of useful antennas. The mathematical representation of this concept is shown as below [13]:

$$N_a = N_{max} - N_{red} \quad (7)$$

Where  $N_{max}$  is the maximum number of antennas that can be deployed in the network which in proposed RNP is assumed 20 antennas.  $N_{red}$  is the number of redundant antennas and  $N_a$  is the efficient and useful antennas.

So in purpose of calculating number of redundant antennas we just need to eliminate each of antennas and calculating the coverage of the network with absence of that antenna; if the coverage has been calculated as before so it means that that antenna is redundant and we have a one redundant antenna, this procedure should be followed

for all antennas till at the end the total amount of redundant antennas will be calculated.

### 3.2.4 Interference

Interference is another important criteria in RNP which can be defined as collision between the efficient antennas [13]. Collision is kind of interference in the network and is a resultant of interrogating one tag by more than one antennas of readers.

Below equation is mathematical representation of a collusion which is accrued by one tag [13]:

$$\gamma(t) = \sum PT_{a,t} - \max \{PT_{a,t}\}, a \in AS \wedge PT_{a,t} \geq T_t \quad (8)$$

And total interference of the network can be calculated some of the all collisions of the network. Mathematical representation of total interference of the network is shown as below as [13]:

$$ITF = \sum_{t \in TS} \gamma(t) \quad (9)$$

### 3.2.5 Transmitted Power

As noted before distance between tag and antennas has a major role in network coverage, since passive tags has been used in this thesis to model RNP network and passive tags will be activated by absorbing the transmitted signal of the antennas of readers so Transmitted power of each antenna has a direct relation with its interrogation range, so reducing the amount of transmitted power may cause in decreasing coverage of the network it has the lowest criteria in RNP[13].

$$POW = \sum_{a \in AS} PS_a \quad (10)$$

Where  $PS_a$  is the amount of transmitted power by antennas.

After introduction to RFID network planning at the beginning of this chapter, criteria which are important and should be calculated in RNP have been introduced. It should be noted that RNP mathematical representation is not capable of making change in coverage, interference or redundancy of the network by changing number of deployed antennas, so in next chapter different RNP optimization processes which can be address to satisfy these criteria will be investigate and proposed.

## Chapter 4

### HYBRID ARTIFICIAL INTELLIGENCE OPTIMIZATION TECHNIQUE

#### 4.1 Overview

RFID technology as a gadget of IoT has been utilized in modern manufacturing to enable manufacturer to track and identify objects or parts to get required data. Fulfilment of this purpose needs to equip objects with RFID tags, and utilize RFID antennas in certain places to enable readers collect data of the objects. Some criteria such as collision of these antennas, coverage of network and transmitted power in network are calculated through a mathematical model [10], [11] and [12]. Calculating these criteria and calculating the number of required antennas for RFID network leads to concept of RFID network planning (RNP) and in higher level concept of optimizing RNP [13] and [23].

Conventional method which has been used in the past is trial and error approach, that was not an efficient and accurate solution to optimize RNP and could only be implemented to not large scale networks [7], [13] and [14]. In recent years with advances in technology and software engineering modern artificial intelligence computational techniques which are more efficient than conventional trial and error technique has been started to utilize to deal with optimizing RNP [13].

The main idea behind of artificial computational intelligent methods is they are not concentrating on one solution, in contrary these methods start with initial solution

and continue with searching the best solution among the all possible solutions [15]. It means that in current iteration from the best exist solution a new solution set will be selected and it will continue till in final iteration the best solution between of the best possible solutions will be selected [16].

Artificial computational intelligent techniques such as Computational as Artificial Neural Networks [16], Fuzzy Logic [17], Genetic Algorithms (GA)[10], [11] and [18], Particle Swarm Optimization (PSO) [13], [19] and [20], Differential Evolution (DE) [9], and hierarchical artificial bee colony algorithm [8] are a point of interest for many scientists working with the RNP problem. In this respect, Han et al [21] for solving and optimizing complicated RNP problems proposed a novel optimization algorithm which is combination of Genetic Algorithm and particle Swarm optimization techniques which is namely known as multi community GA- PSO. PS<sup>2</sup>O optimization algorithm has been adopted by Hannin et al [7] by concentrating on optimizing position of the deployed antennas of readers in the network. To optimize RNP parameters PSO based solution has been proposed by Azli et al [22] . Shilei et al [23] has concentrated on optimizing coverage of RNP by multidimensional optimizing k-coverage model, and finally one of the most recent researches which concentrating on combining two optimization techniques has been conducted by Yue et al [13], the mentioned research has combined PSO algorithm with redundant reader elimination for optimizing RNP.

The most of the studies which have been reviewed in this thesis have concentrated on the satisfying RNP criteria based on the optimizing positions of deployed antennas, and these research so not deal with optimizing number of the antennas. In this case

number of the antennas remains constant and just position of them are changed by optimization techniques.

It has a great importance for optimizing all RNP criteria, because the ultimate goal of optimizing RFID network is not only optimizing criteria such as coverage, interference and etc. of the network also calculating the number of antennas in a cost efficient manner should be considered as one of the main criterion [16]. In brief the goal of RNP and optimizing it can be summarized as following statement: To plan a cost efficient RFID network it is necessary to minimize the number of antennas, minimize interference of antennas and maximize coverage area of objects [11] and [16].

Therefore, in this thesis, to satisfy these targets and design an efficient RFID network a hybrid optimization techniques is introduced. Hybrid term refers to combining to different algorithms to optimize RNP as one optimization approach (see figure 19).

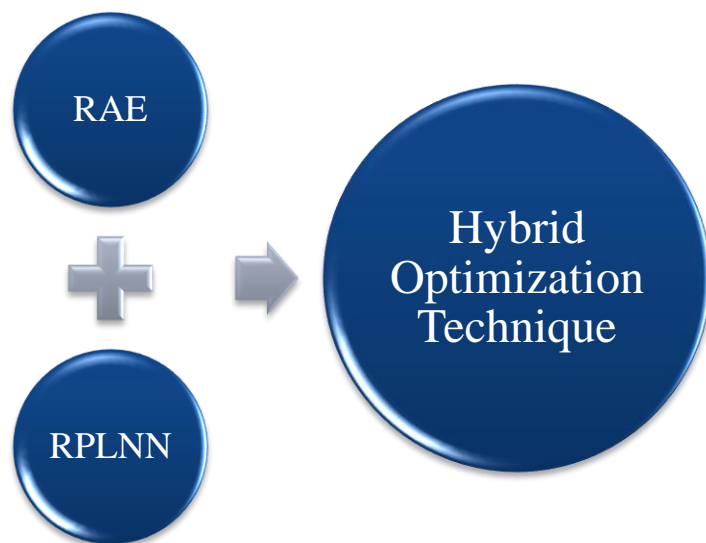

Figure 19: Proposed Hybrid optimization technique

In this purpose Ring Probabilistic Logic Neural Networks (RPLNN) as a novel technique in RNP optimization is introduced. The algorithm of RPLNN is designed in a way which has been made capable the paradigm to adjust the number of embedded antennas in the network, so it makes RPLNN optimization technique an efficient artificial computational intelligent optimization approach to deal with complex RFID network planning problems.

The second component of the proposed hybrid algorithm is utilizing redundant antenna elimination (RAE) optimization technique in addition to RPLNN optimization technique. Utilizing RAE algorithm has two advantages, the first privilege is reducing optimization process by reduction of iterations and the other one is give flexibility to RNP in terms of number of antennas.

The priority of the combined algorithms in the proposed hybrid optimization process of RNP belongs to RAE paradigm, and it has been used before RPLNN technique. It means that first RAE eliminates redundant antennas in the network in each step of optimization and then RPLNN optimization technique will be applied to only non-redundant antennas (see figure 20).

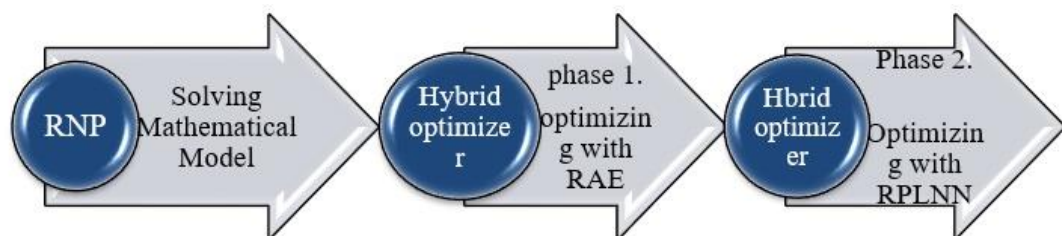

Figure 20: RNP optimization process

After giving an introduction about the goal of optimization of RNP and criteria which should be satisfied by optimizing RNP, different computational artificial intelligence optimization techniques have been reviewed and a hybrid artificial intelligence optimization algorithm has been proposed to deal with RNP. Remaining sections of this chapter has been organized as following: first the methodology of this research which is the proposed hybrid artificial intelligence algorithm and its components has been introduced and discussed in detail, to have an comparison between proposed approach and other existed approaches the second part another artificial intelligent technique namely Genetic Algorithms as a well-known optimization technique in evolutionary optimization approaches has been introduced. In next chapter, chapter 5, both of the approaches are implemented to optimize an RNP and results are compared.

## **4.2 Methodology**

The aim of this thesis introducing a novel hybrid artificial intelligence optimization technique which is capable to deal with complex RNP problems. Proposed hybrid paradigm is capable to adjust the number of deployed antennas in the RFID network as same as optimizing other criteria of RNP such as achieving maximum tag coverage in the network, minimizing antenna collision and interference of the network. Proposed hybrid algorithms has been made of two artificial intelligence optimization paradigms which performing optimization process in form of a series network. The first phase of the optimization has been done through redundant antenna elimination (RAE) algorithms and it has been followed by Ring Probabilistic Logic Neural Networks (RPLNN) paradigm to accomplish the optimization process (see figure 20). Flowchart of proposed hybrid artificial intelligence optimization paradigm has been shown in figure 21.



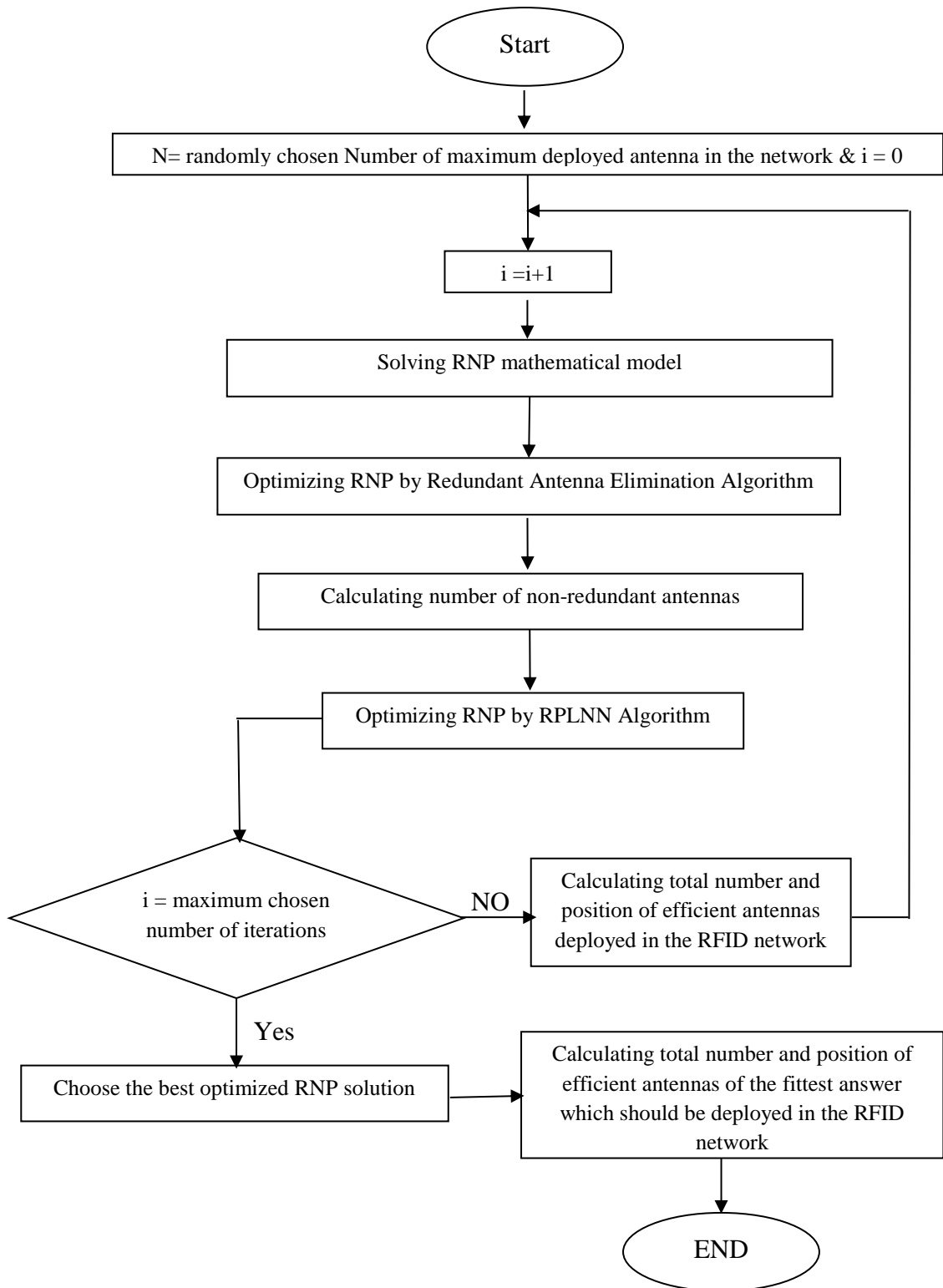

Figure 21: Proposed Hybrid Artificial Intelligence optimization process

The first step of optimization process of RNP starts with solving the proposed mathematical model of RNP which discussed in previous chapter of this thesis (see figure 21). All parameters of RNP which are coverage, redundancy and interference of the RFID network should be calculated. To fulfill this task total number of deployed RFID antennas in the network should be known, so in the first iteration this number has an arbitrary value. After calculating all parameters of RNP the next step is optimization process through Redundant Antenna Elimination (RAE) Algorithm. In this step of proposed hybrid artificial intelligence algorithm all antennas which deployed as non-efficient antennas and impose extra cost to network which is the resultant of redundancy are eliminated and deleted from RFID network. After the RAE optimization process has been finalized it is time to calculate the total number of non-redundant antennas which remain on the RFID network. The next step of optimization process is applying second phase of hybrid Artificial Intelligence algorithm which is Ring Probabilistic Logic Neural Networks (RPLNN) algorithm. It is important to know that RPLNN algorithm optimizes the RNP based on non-redundant antennas which has been calculated by RAE algorithm. The next step is deciding if optimization process has been finished or not, to perform this task at first the number of iterations which are required for whole hybrid optimization process to optimize RNP should be defined by user. After phase of optimizing RNP utilizing RPLNN technique if iterations has reached to predefined number of iterations in that case optimization process should be stopped and best solution for RNP should be chosen. If iteration has not been completed in this case maximum number of deployed antenna in the network should be calculated and RNP optimization process from the step of solving mathematical model for RNP. The hybrid artificial

intelligence optimization process continues till iterations reach to predefined number of iterations.

After an introduction to proposed hybrid artificial intelligence algorithms and overviewing the flowchart of the algorithm, the whole optimization process has been introduced. In next section the two components of hybrid artificial intelligence algorithm which has been adopted to deal with RNP problem have been introduced. These algorithms which are namely known as redundant antenna elimination algorithm and ring probabilistic logic neural networks in the next sections have been discussed in detail.

#### **4.2.1 Redundant Antenna Elimination Algorithm**

The logic of the optimization process through Redundant Antenna Elimination (RAE) paradigm is based on deleting redundancy on the RFID network. Terms of redundancy means that an excited RFID tag has been covered by two different RFID antennas of readers. It happens when a tag receives an activation signal from an antenna and starts to backscatter this signal, the emitted signal from the tag can be received by more than one antenna and tag will be covered by more than one antennas. Since coverage of the network by eliminating all of the antennas except one of them do not be changed and remains constant so it means that the other antennas is considered as redundant antennas on the network and should be eliminated.

In the first step of the optimization process RAE algorithm optimize RNP in each iteration of the optimization task by eliminating redundant deployed antennas by performing flowing procedure.

First of all coverage of the RFID network by the RNP mathematical model which has been introduced in section 3.2.1 of this thesis has been calculated, the next step is calculating the redundancy of the network by the mathematical formulation which has been discussed in section 3.2.2 of this study. To perform this task deployed antennas in the RFID network should be eliminated one by one and coverage of the RFID network should be calculated after each antenna elimination. If the total calculated coverage of the RFID network after each antenna elimination remains as before antenna elimination then the eliminated antenna remains as deleted, otherwise if the total calculated coverage of the network after the antenna elimination be less than the RFID network coverage before the antenna elimination then eliminated antenna should be recovered and undeleted.

This procedure should be repeated for all of the antennas, each calculation step which has been performed for each antenna namely known as on iteration, so the number of the iteration of this algorithm should be equal to total number of deployed antennas into the RFID network.

In each iteration of the optimization utilizing RAE paradigm if a redundant antenna has been founded by the algorithm in that case number of the redundant antennas which has been eliminated will be added by one.

After performing the last iteration of the RAE optimization process which is investigation redundancy of the last deployed antenna in the RFID network, total number of redundant antenna can be calculated and by calculating this number and knowing the total deployed antenna in the RFID network total non-redundant antennas has been calculated and has been prepared to go for next step of the hybrid

optimization technique which is performing optimization through RPLNN paradigm on non-redundant antennas.

The proposed RAE optimization algorithm can be summarized as below steps (see figure 22):

- a. Total coverage of RFID network has been calculated ( $C_1$ )
- b. First deployed antenna in the RFID network should has been eliminated
- c. After the antenna elimination, again total coverage of RFID network has been calculated ( $C_2$ )
- d. If coverage of the network after antenna elimination has been calculated less than before antenna elimination ( $C_2 < C_1$ ) then eliminated antennas has to be recovered.
- e. If coverage of the network after antenna elimination has been calculated equal to before antenna elimination ( $C_2 = C_1$ ) then the antenna should has been remain eliminated and number of the redundant antennas has been added by one.
- f. The RAE optimization process has been ended after investigating the redundancy status of the deployed antenna in the network and by then number of the non-redundant antennas has been calculated and has been ready for next phase of hybrid artificial intelligence optimization process.

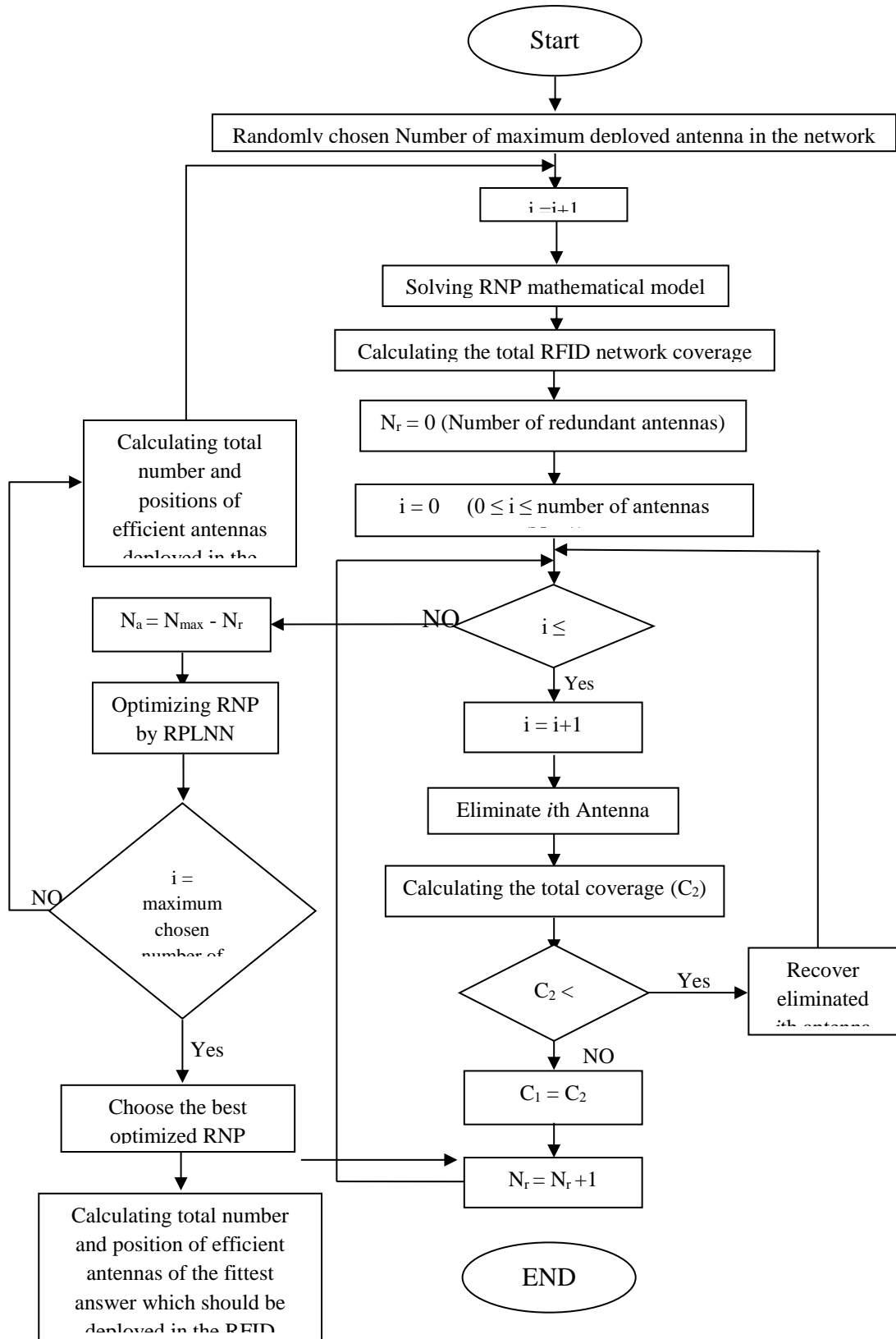

Figure 22 : Flowchart of the Proposed Redundant Antenna Elimination Algorithm

## 4.2.2 Ring Probabilistic Logic Neural Networks

The second part of the proposed hybrid optimization technique is Ring Probabilistic Logic Neural Networks (RPLNN) which also is known as Ring Probabilistic Logic Neural Networks (RPLNN). RPLNN paradigm is a part of RAM based Weightless Artificial Neural Networks (WANN), so before proposing the utilized structure of this algorithm in this thesis a brief review of Neural Networks (NN), RAM based WANN, structure of a Probabilistic Logic Neuron (PLN) and RPLNN have been given in following sections.

### 4.2.2.1 Neural Networks

Networks of biological neurons which are connected to central nervous system to perform a specific physiological function conventionally has been known as Neural Network (NN) (see figure 23), but in past dictates with advances in software engineering a new term which relies on artificial neurons has been proposed and namely known as Artificial Neural Networks (ANN) [6] (see figure 24).

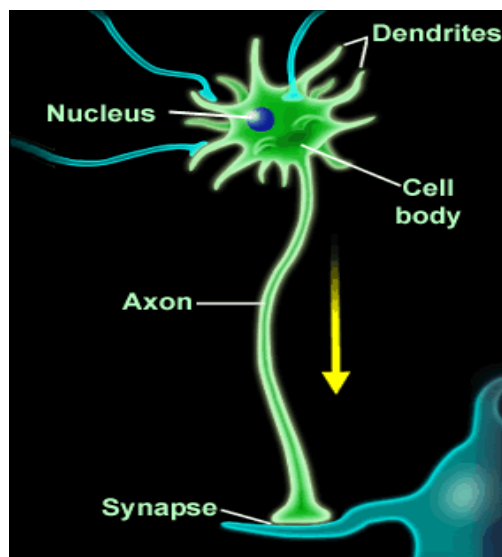

Figure 23 : Biological Neuron [6]

As seen figure 23 more than one neurons can be connected to a single neuron through axons and dendrites and built the bio logical neural networks. Through the connection points which are namely known as synapses neurons communicate with central nervous system by sending electrical signals [35].

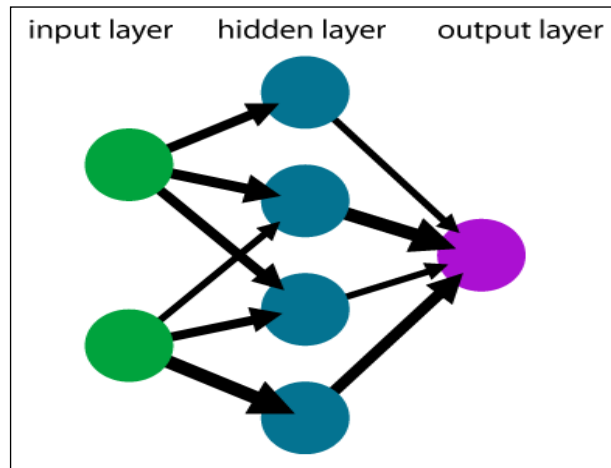

Figure 24 : Example of Artificial Neural Networks [21]

The purpose of Artificial Neural Networks models is simulating functions of Biological Neural Networks. ANN have been utilized to different engineering and science fields such as control [24], data processing [25], robotics [1], function approximation [41], pattern and speech recognition [42].

As seen in figure 24 ANN has been made of interconnecting neurons which have been categorized in three layers which namely are input layer, hidden layer and output layer [43]. Based on the type of connections between these neurons artificial neural networks can be divided in two different groups: Weighted Artificial Neural Networks and Weightless Artificial Neural Networks [44].



After a brief introduction about Neural Networks, Since RPLNN has been categorized as part of weightless artificial neural networks the next section has been organized to give an overview of weightless artificial neural networks.

#### **4.2.2.1.1 Weightless Artificial Neural Networks**

Weightless artificial neural networks has been known as simply implemented artificial intelligent dynamic paradigms which had been proposed for the first time in 1965 by Aleksander, I. et al [50]. The proposed Idea was based on design devices which have random access memories. Beldose et al [51] was the first who implemented the idea of weightless artificial neural networks to build pattern recognition device. General Neural Unit model (GNU) which was a novel model in weightless artificial neural networks modelling was proposed by Aleksander, I. et al [52]. The proposed model was a building block to build cognitive structures. In 1993 Aleksander, I. et al [55] proved that at the machine state artificial consciousness can be discussed by weightless artificial neural networks models.it means that complex cognitive behaviour of humans can be modelled by utilizing such machines as building blocks.

The idea of utilizing random access memory (RAM) is the base of weightless artificial neural networks. In general RAM refers to a device with more than one input and just one output or in the other word RAM is a multi-input single output (MISO) device. Inputs and output should be in binary form and it means that based on the input data which is in the form of 0 or 1 various locations of memory can be entered (see figure 25).

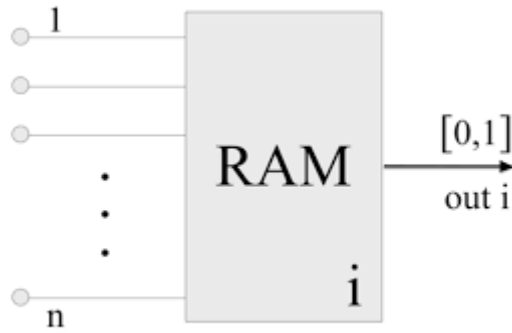

RAM neuron i

Figure 25 : A RAM neuron [54]

Since the inputs are in binary form and each set of the inputs can have access to only one single location of stored output, then for  $N$  inputs number of the output locations in memory should be  $2^N$ .

#### 4.2.2.1.1.1 RAM Neural Networks

More than one RAM neurons can be utilised to build up a RAM network. As seen in figure 26 RAM networks consists of two layers which namely known as RAM layer and output layer. RAM layer is built of  $K$  different RAM neurons which each of them has input vector with size of  $N$ . the output layer is nothing more than a summation node which output values of all RAM neurons are added up in that node. It should be noted that in concept of RAM networks length of each set of the input data is one-bit [55].

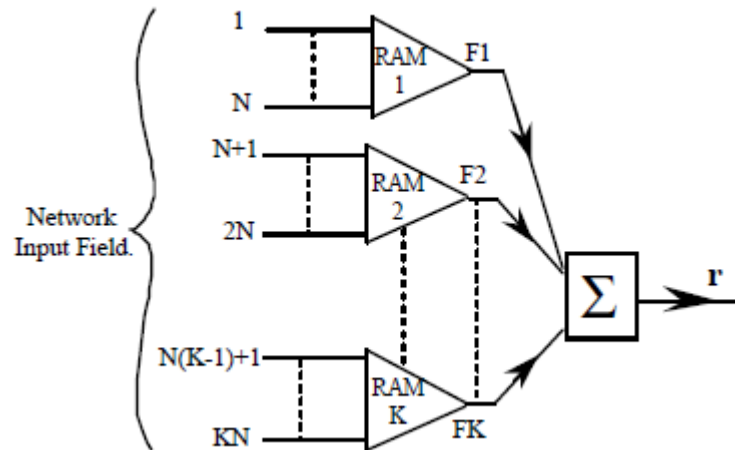

Figure 26 : A RAM Discriminator [56]

The training algorithm of a RAM Neural Network is described as below [56]:

- 1) Start
- 2) Giving the input in form of binary code (0 or 1) which known as pattern should be followed to first RAM.
- 3) If the input can accessed the memory location output value should be set up to 1 (F=1)
- 4) If the input cannot accessed the memory location output value should be set up to 0 (F=0)
- 5) Repeat steps 1 to 3 for all RAM neurons
- 6) Calculate sum of all outputs ( $\sum F = r$ )

- 7) If calculate sum of all outputs is equal to total number of RAMs, then pattern is recognised. ( $r = k$ )
- 8) If calculate sum of all outputs is less than total number of RAMs, then pattern is not or partially recognised. ( $r < k$ )

The discussed training algorithm of RAM Neural Network is summarized as a paradigm flowchart in figure 27.

After giving a brief introduction regards to weightless neural networks and idea of constructing and developing this concept based on random access memory which namely is known as RAM, the Ram neural network and the training paradigm of this network has been introduced and discussed. Following after, in the next section ring probabilistic logic neuron as advanced concept in building weightless neural models has been introduced.

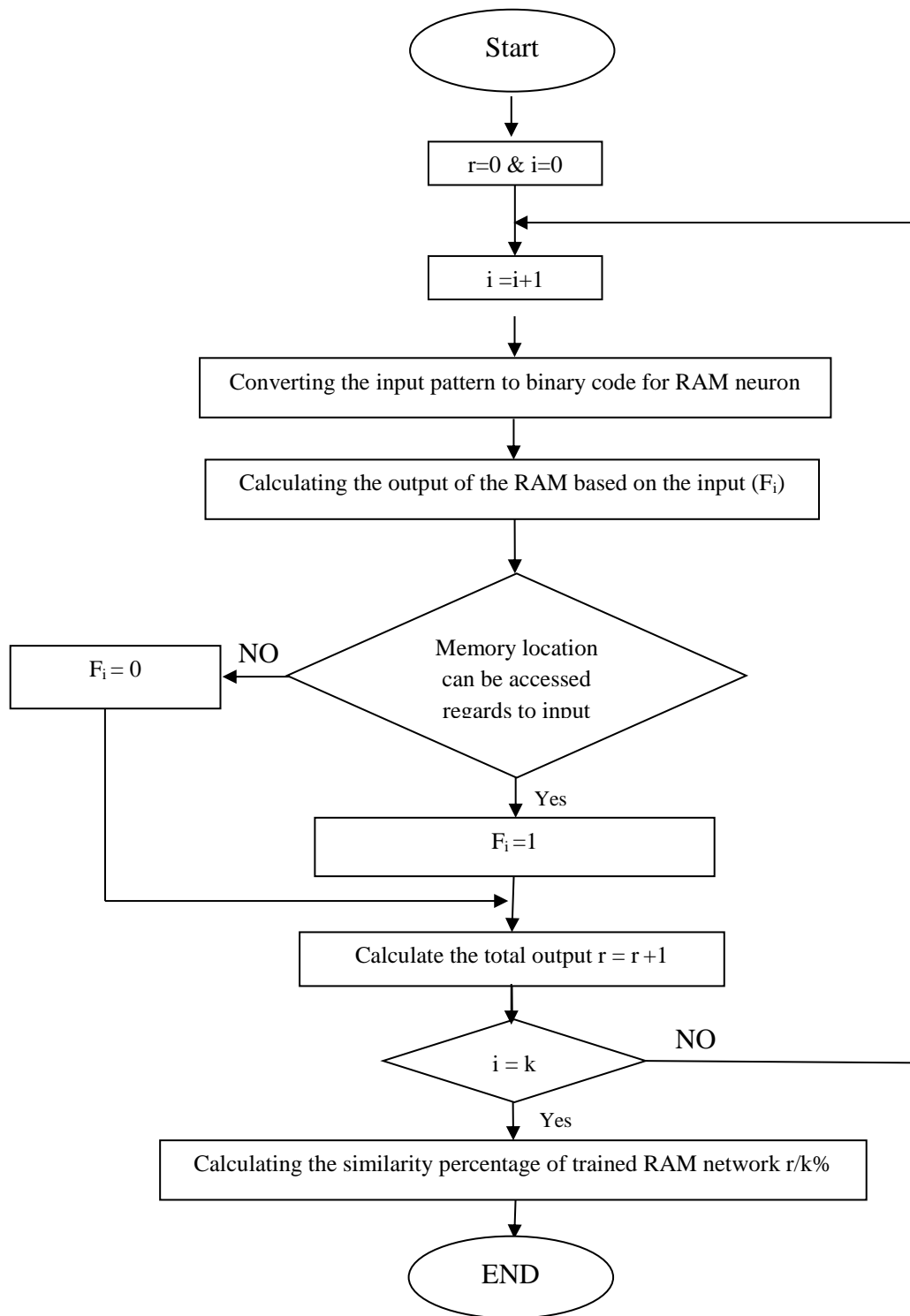

Figure 27 : Flowchart of training algorithm of RAM Neural Network

#### 4.2.2.1.1.1 Probabilistic Logic Neural Networks

The Probabilistic Logic Neuron (PLN) is a RAM based device which proposed in 1988 by Aleksander, I et al. [56]. As seen in figure 28 a PLN is made up from a probabilistic node which based on the input array calculates the output array. Probabilistic node term refers to the probability percentage of each node which can be calculated through dividing the output of a PLN to maximum output which can be stored in memory.

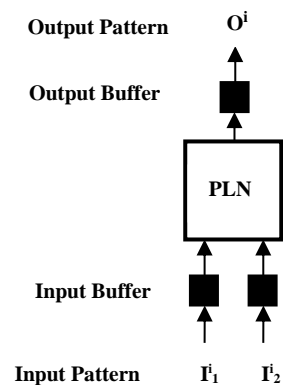

Figure 28 : Probabilistic Logic Neuron (PLN)

PLNs from point of the value and length of the output have two major differences with RAM neurons. RAM neurons can store their output in length of one-bit in memory location, however PLNs are capable of store outputs which have greater length than one-bit which namely is known as B-bit [57]. The other difference is the outputs of RAM neurons can be 0 or 1 however outputs of PLNs rather than having these two options has a third state which is “Don’t Care” state and represented by “X”. “Don’t Care” state refers to the outputs which can have value of 0 or 1 with probability of 50% [58].

By adopting the “Don’t Care” state the meaning of the output 0 has been changed in PLNs. It means that state of 0 has two meaning in PLN concept, firstly it can be interpreted that for the given input vector the PLN neuron has not been trained, and the second one is the 0 can be interpreted as the calculated output of the trained PLN which is opposite of the RAM neuron concept. It can be said that utilizing this third state enabled PLNs to have better performance compared to RAM neurons, and as an important option they opposite with RAM they can have more than two layers. As seen in figure 29 PLNs can combined together and built PLN neural network with paramedical structure.

The PLN neural network has been proven can deal with hard learning problems, and consists of many PLN neurons (shown as size of  $W$ ) which each has  $N$  inputs and more than one hidden layers (shown as size of  $D$ ) which insures robustness of PLN Neural Networks.

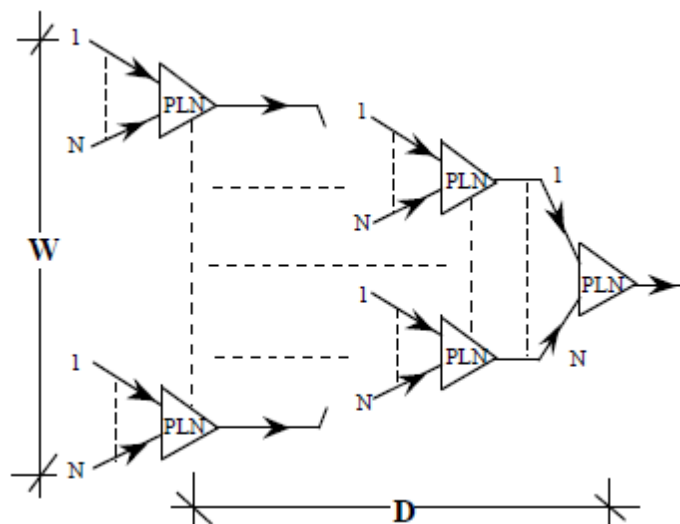

Figure 29 : Pyramidal PLN Neural Network structure [ 59]

In general PLN Neural Networks do not have a rigid structure and based on the requirements of the problem by combining PLNs in different manner can design different PLN Neural Networks (see figures 29 and 30).

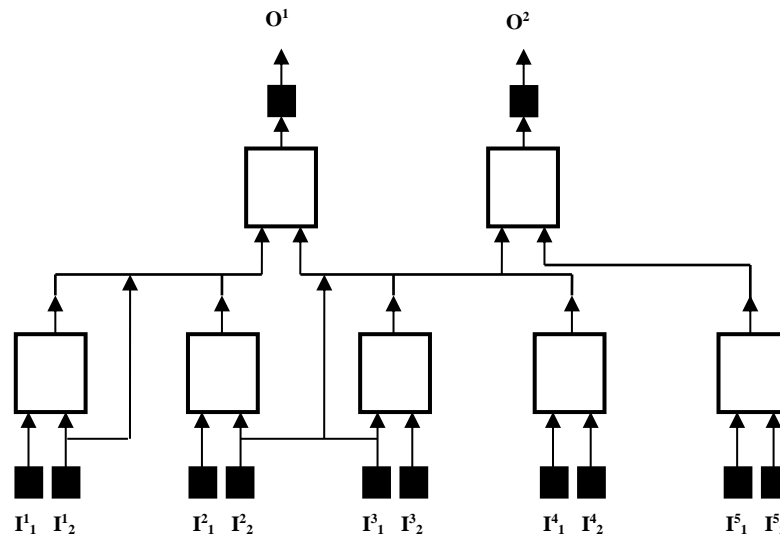

Figure 30 : Example of a PLN Neural Network structure [60]

These kind of PLN Neural networks also are known as Multi-layer PLN network (MPLN). The efficiency of MPLNs network has been investigated and analyzed in detail by Zheng et al. [61]. The research result indicates that being flexible in arrangements of PLNs gives an advantage of having fast and efficient convergence time to find the final solution of hard learning problems by MPLNs.

#### 4.2.2.1.1.1.1 Ring Probabilistic Logic Neural Networks

In year 2002 based on the flexibility of structural design of MPLNs a new structure which namely is known as Ring Probabilistic Logic Neural Networks (RPLNN) to deal with optimization problems proposed by Menhaj et al. [62]. The proposed structure connects input of the first PLN to output of the last PLN, so this connection



based on the available data sets can be divided to two different groups which are namely feed forward and feedback connections.

The feed forward connection state happens when input data of the first PLN be available, so this data goes as feed forward signal to the output of the last PLN. The feedback connection state happens when the output data of the last PLN be available, so this data goes as feedback signal to the input of the first PLN. This feedback and feed forward connection which connects first and last PLNs are namely known as ring structure, and because of this property the name of this kind of MPLN network is known as Ring Probabilistic Logic Neural Network (RPLNN). In 2016 Azizi et al. [63] utilized RPLNN structure as a part of weightless Neural Networks to optimize weighted Artificial Neural Networks model of mechanical behaviour of friction steer welding (see figure31). A special structure of this algorithms from point of defining inputs and outputs of the RPLNN has been implemented in this thesis to deal with RNP problem which has been discussed in detail in the next chapter of this thesis.

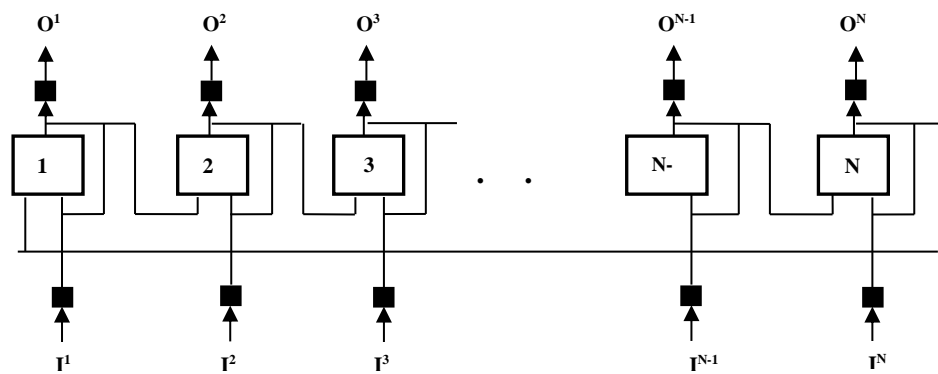

Figure 31 : RPLNN structure [63]

In RPLNN structure each PLN has its own truth table which sets the output value based on the input vector to 0, 1 or don't care states. The training of RPLNN can be summarized as continuing training process till all don't care states have been

replaced with values 0 or 1 [52]. It means that RPLNN structure as the second phase of proposed hybrid artificial intelligence optimization paradigm fulfills the task of optimization based on pure random search among the all possible solutions [63] and [54].

The RPLNN optimization process starts with converting the inputs in form of binary codes which is made of zeroes and ones, it is followed by creating a population of possible answers to the problem, the next step is evaluating each of the existed answers in the defined population to know which of them is the best answer and has the fittest value, so to perform the evaluation task defining a fitness function is essential. It should be noted that the fitness function should be defined per criteria of the problem which required to be optimized and differs from one problem to another [64]. The fitness function which has been used in this thesis to optimize RNP has been introduced in detail in the next chapter.

The proposed RPLNN algorithms which has been adopted in this thesis as a part of proposed hybrid artificial intelligent algorithm is shown as flowchart in figure 32.

After calculating the total number and position of non-redundant antennas by the first part of proposed hybrid optimization paradigm which is RAE, second phase of optimization is started with RPLNN by calculating all criteria of RNP mathematical model by utilizing positions of non-redundant antennas. The calculated positions of non-redundant antennas at the parallel procedure are encoded as binary code to create the population of all possible answer. The detailed discussion about how to create the population of all possible answers has been given in next chapter. Each existed answer in population namely is known as individual, and the next step is

evaluating each of these individuals by defined fitness function to optimize RNP which has been discussed in detail in next chapter. In the same time as parallel process output of the each PLN in proposed RPLNN structure should be calculated by PLN truth table regard to encoded binary positions of non-redundant antennas as inputs. The next step is decoding calculated binary output to decimal vector which is new positions of antennas and solving RNP mathematical model based on these new positions of antennas. The next step is calculating fitness function of RNP based on calculated criteria which achieved by applying new positions of antennas. The next step as comparing two calculated fitness functions based on two different positions of antennas given as RPLNN inputs and outputs, if the fitness function of RPLNN output be less than the calculated fitness function of RPLNN input then all calculated RPLNN outputs which are the binary form of positions of antennas should be returned back to don't care status otherwise all calculated outputs should be saved as be calculated. These proses continues till optimization process completes all pre-defined number of iterations and the last step is choosing the nest answer of the calculated population of the antennas based on its fitness function. It means the fittest individual of the population of answers is the best solution of proposed optimization algorithm.

The second phase of proposed hybrid artificial intelligence algorithms; RPLNN; which has been adopted to deal with RNP in this thesis can be summarized as following steps:

1.
  - A. Encode the positions of non-redundant antennas calculated by RAE to binary codes and create population of possible answers.

- B. Solve RNP for calculated non-redundant positions of antennas by RAE
- 2.
- A. Calculate the output of each PLN of RPLNN by truth table of PLN regards to inputs.
  - B. Decode RPLNN outputs to decimal position of antennas vectors.
  - C. Solve RNP for calculated positions of antennas.
- 3.
- A. Calculate the fitness function value for each individual of inputs of RPLNN which are calculated positions of antennas.
  - B. Calculate the fitness function value for each individual of outputs of RPLNN which are calculated positions of antennas.
- 4.
- A. If the calculated fitness function value of output of RPLNN be more than the calculated input fitness function value, then save the value of the outputs of the RPLNN.
  - B. If the calculated fitness function value of output of RPLNN be less than or equal to the calculated input fitness function value, then reset the value of the outputs of the RPLNN and set all of them as don't care state.

- C. Repeat these steps for the predefined number of iterations.
5. Choose the best and fittest answer between all possible solutions.
6. Calculate number and positions of efficient antennas which should be deployed on RFID network.

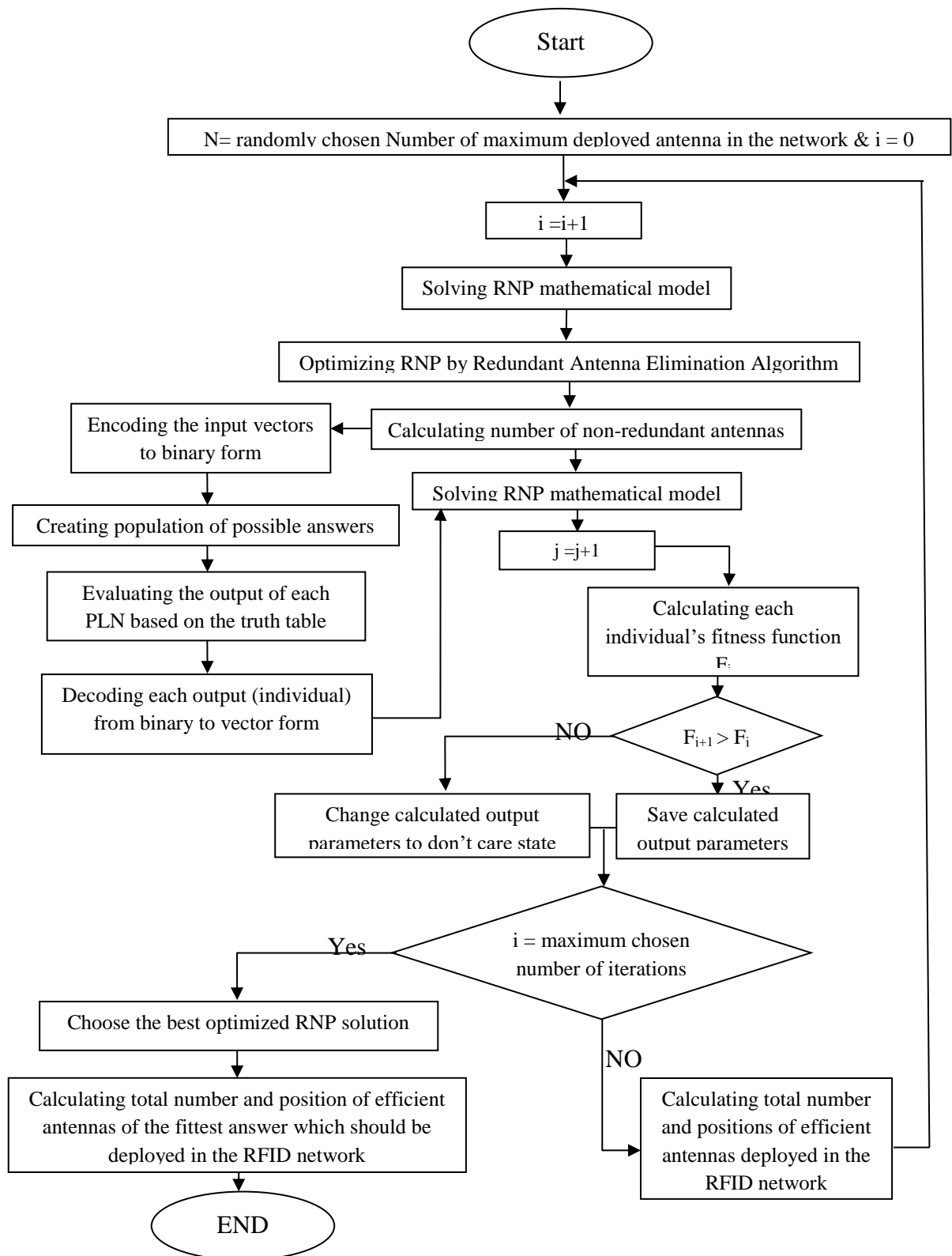

Figure 32 : Flowchart of the Proposed RPLNN algorithm to Optimize RNP

After introducing the components of the proposed hybrid algorithm, in the next section to have a comparison of the performance of the proposed algorithm and other algorithms which have been adopted by other researchers a well-known evolutionary optimization technique known as Genetic Algorithm (GA) has been introduced to optimize the RNP.

It has a great importance to know since GA and other algorithms are not capable of adjusting number of deployed antennas, in this thesis GA has not been adopted as sole optimization technique and it has been combined by RAE.

### **4.3 Genetic Algorithm**

Genetic algorithm is one of the well-known evolutionary optimization techniques which has been adopted by many researches to optimize complex problems [36] and [37]. Briefly the optimization process by GA can be divided to 6 steps as following:

- 1) Creating population of possible answers
- 2) Evaluation of fitness function.
- 3) Creating next generation of possible answers.
- 4) Applying Crossover
- 5) Applying Mutation
- 6) Repeat steps 2-5

The first and the second steps which are creating population of possible answers and evaluating performance of them by fitness function have the same procedure as have been discussed in the implementation chapter of this thesis.

The next step is creating the next generation of the population of possible answers by adopting an appropriate selection procedure [41] and [42]. In this thesis roulette wheel selection approach [65] has been utilized to make the select the best answer through calculating the fractional fitness function of each possible answer which has been defined as below:

$$F(x_i) = \frac{f(x_i)}{\sum_{i=1}^n f(x_i)} \quad i = 1 \dots \text{number of antennas} \quad (11)$$

Equals to the number of the possible answers of the population which has been taken as 100 in this thesis, the roulette wheel should be spinet for 100 times to select an answer to generate the next generation of the possible answers (see figure 33).

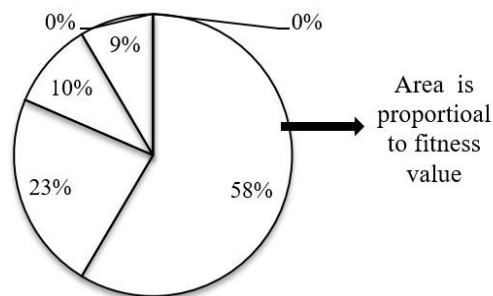

Figure 33: Example of Roulette Wheel [65]

The next step is applying crossover to the generated population. Crossover operator combines different parts of two different answers (chromosomes) known as parents and produces new chromosomes known as children. Crossover can be adopted as two



points crossover (see figure 34.a) or single point crossover (see figure 34.b). In this thesis single point crossover has been adopted as the operator of GA.

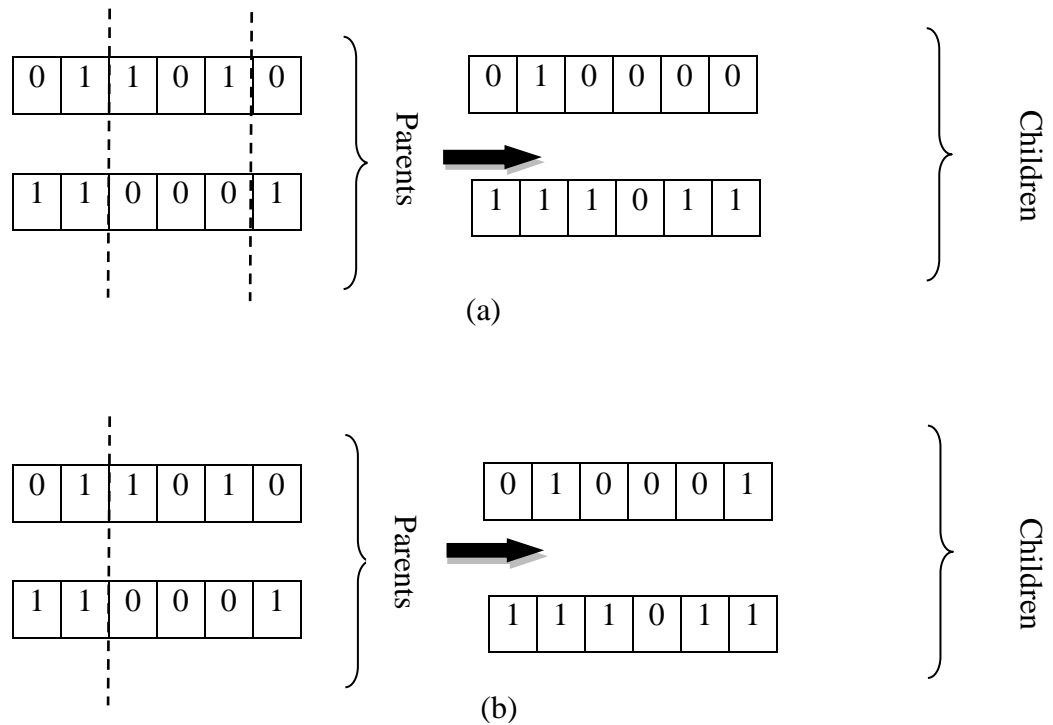

Figure 34: (a) two points Crossover, (b) single point crossover [65]

The final step of optimization by GA is adopting another operator known as Mutation. Mutation. The mutation operates as NAN function on one of the binary bits of the answers (gen). It means that if the gene has binary value of 0 the mutation operator will change it to 1 and if it has binary value of 1 the operator will change it to 0 (see figure 35).

These should be repeated till predefined criteria be satisfied, which this criterion in this thesis has been taken as completing 100 iterations of the optimization process.



Figure 35: Example of Mutation [65]

After introducing the proposed hybrid artificial intelligence paradigm and the components of it, a well-known evolutionary optimization technique which is known as Genetic Algorithms has been introduced in detail. In the next chapter both of these algorithms have been implemented for optimizing the proposed RNP and results have been analyzed and discussed in detail.

## Chapter 5

### IMPLEMENTATION

#### 5.1 Overview

Implementation of the proposed hybrid artificial intelligence algorithm to solve and optimize a RNP has three phases which are: defining working area which an RFID network should be established, optimized and defining the parameters of the proposed algorithm and implementing the optimization algorithm to defined RFID network.

#### 5.2 Working Area

The first step of design a RFID network is defining the working area which RFID tags should be covered by deployed antennas, and the proposed hybrid artificial intelligence algorithm has to be implemented to this working area to optimize number and positions of deployed RFID antennas. To perfome this task two deferent working areas which have various properties have been defined in this thesis. The first one is the Static working area and the other one is the Dynamic working area.

##### 5.2.1. Static Working Area

The proposed static working area in this thesis is a square room with dimension of  $100 \times 100 \text{ m}^2$ , and consists of 20 RFID passive tags which randomly have been distributed in this working area. The static state refers to the movement state of the tags which has been considered as not moving tags. A good example of this status can be given as parts which have been imbedded with RFID tags in warehouses. The

proposed static working area has been modeled with MATLAB software (see figure 36).

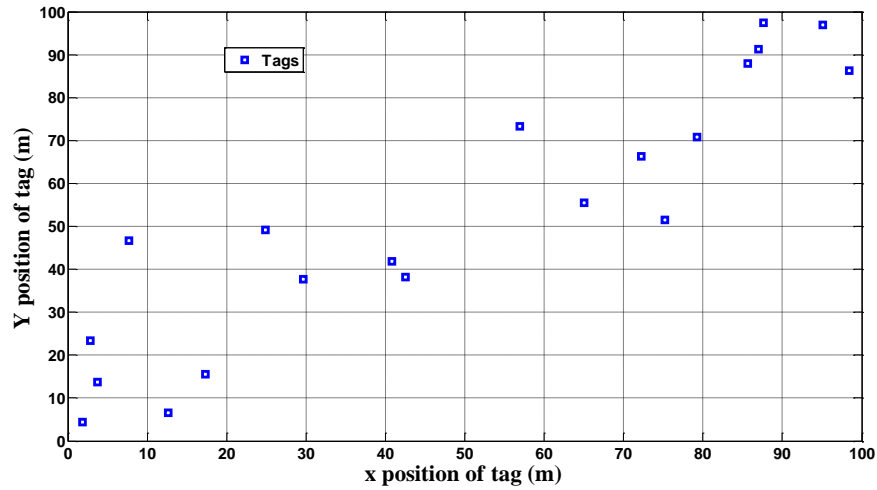

Figure 36 : Proposed Static Working Area

### 5.2.2 Dynamic Working Area

Contrary to the static working area which tags have been pinned to their locations, in dynamic working area tags have changing positions and have moving status.

The proposed dynamic working area in this thesis is the conveyer belt located in Flexible Manufacturing Systems Laboratory (FMS) of Eastern Mediterranean University (EMU) (see figure 37).



Figure 37 : FMS laboratory of Eastern Mediterranean University (EMU)

Using MATLAB software the conveyor belt which has 3m length and 2m width has been modeled. It is assumed that the conveyor moves with constant speed of 0.3 m/s, and square shape parts with length of 15cm which has been equipped with RFID passive tags move along the conveyor with 15cm distance with each other (see figure 38).

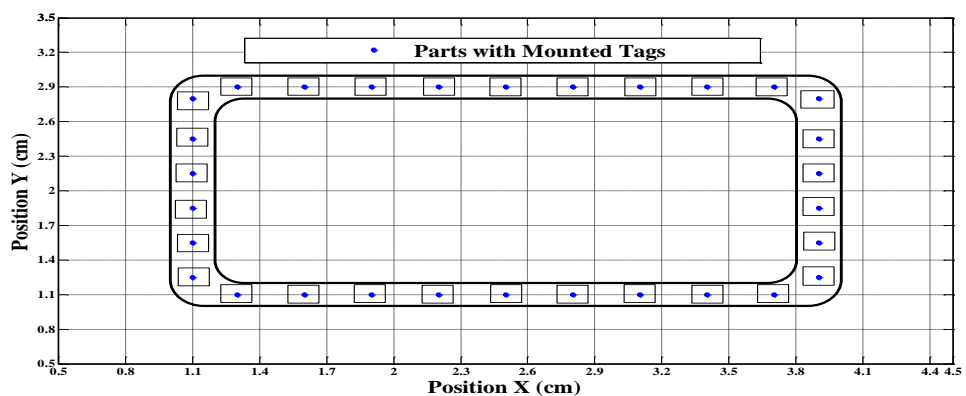

Figure 38 : Proposed Dynamic Working Area

The tags are mounted on the middle of each part and moving with parts, so by defined proposed working area conditions can be interpreted in following two different scenarios:

- A. One tag moves along the conveyer and its speed is equal to conveyer speed and in each 2 second tag moves 30 cm, so to complete a tour in conveyor tag should be detectable in 30 different positions.
  
- B. Tags move along the conveyer and their speed are equal to conveyer speed so in each second each tag moves 30 cm, so in whole conveyer 30 tags move in the same time.

It should be noted that all 30 tags should be covered by RFID antennas in the same time, so it can be interpreted that 30 static tags have been deployed on the RFID network in both cases A and B.

After defining the working area and modeled it with MATLAB software the next step is defining the parameters of the proposed algorithm.

### **5.3 Parameters of the Proposed Hybrid Algorithm**

Parameters of the proposed hybrid artificial intelligence algorithm which should be defined are divided to two sections: first the population of the possible answers should be defined and the next one is defining the objective function of the algorithm.

### 5.3.1 Population of the Possible Answers

Population of the possible answers can be defined as a matrix with  $m$  rows and  $n$  columns which each row of the matrix contains an answer of optimizing the proposed RFID network. Number of rows is a predefined arbitrary number which has been assumed in this thesis as 100, so the optimization process starts with 100 possible answers to RNP known as global answer space or population of the possible answers, and tries to optimize it to accomplish the optimization process by searching the best answer in the global answer space.

As it has been discussed in previous chapters optimization process starts with solving the mathematical model of RFID network and ends with choosing the best solution. Solving the mathematical model needs the number and positions of the RFID antennas which in the first iteration of the proposed optimization technique has been chosen randomly (here in this thesis it has been chosen to number of the tags), but in the other iterations the required data have been provided by RPLNN algorithm. Each answer in the population of possible answers can be defined as combination of the position of deployed RFID antennas and activity status of them.

The position of antennas have be defined in Cartesian coordinates as  $(x, y)$ , and activity status refers to state of the antenna which is *on* or *off*, so if an antenna activity calculated as *off* it means that the antenna has not been deployed on the RFID network.

The positions and activity status of the antennas should be encoded in binary form as zeroes and ones at the output of RAE algorithms which is the input of the RPLNN algorithm, and should be decoded to decimal form at the input of mathematical

model which is the output of the RPLNN algorithm. In this case the number of the columns of the population matrix equals to binary string length of positions and activity status of antennas (see figure 39).

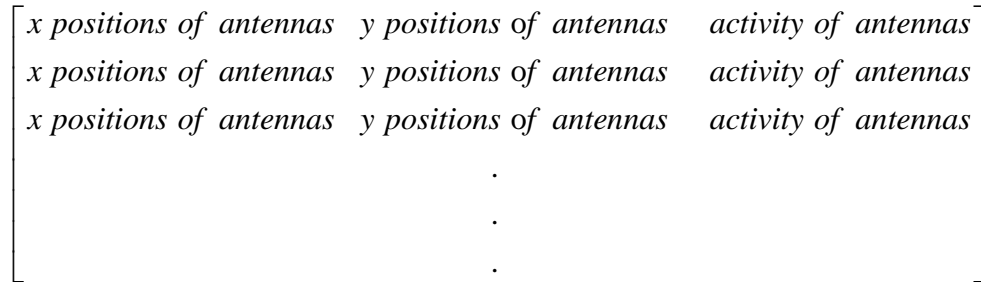

Figure 39 : Proposed Population of Possible Answers

It should be noted that for the activity status of antennas in this thesis 0 has been considered for non-active antennas and 1 has been taken for active antennas. An example of the possible answer encoded to binary form has been illustrated in figure 40.

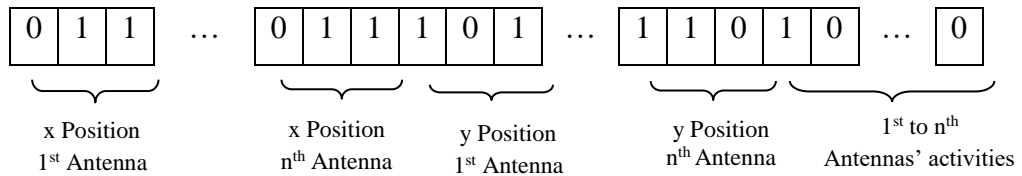

Figure 40: Example of Encoded answer in Population of Answers

### 5.3.2 Fitness Function

The fitness function is an evaluation tool which roles over the optimization process, and can be interpreted of combination of the parameters of the RNP which should be maximized or minimized through optimization algorithm. Each row of the population of the possible answers matrix should be evaluated by the fitness function, and the



possible answer which has the highest value of fitness function is the best optimization solution.

The aim of the proposed hybrid artificial intelligence algorithm in this thesis is establishment of an optimized RFID network by minimizing the number of deployed antennas in a manner which coverage percentage of the network reaches maximum and interference of the network reduces to minimum possible value.

The following fitness function which has been proposed in this thesis to evaluate performance of the each possible answer of population matrix:

$$f(x_i) = \frac{100}{1 + (100 - COV(i))^2} + \frac{100}{1 + ITF^2(i)} + \frac{1}{1 + (Number\ of\ Antennas)^2} \quad (12)$$

$i = 1 \dots population\ size$

The value of the proposed fitness function increases by increasing the network coverage and decreasing interference and number of deployed antenna in the network. Since coverage of the network depends on the RFID antennas, so to have covered tags at least one antenna should be deployed on the network. In this case if the network coverage by adopting one antenna reaches to 100% and interference reduces to zero, so the maximum value of the proposed fitness function value will be calculated as 201.

After defining the working area and parameters of the proposed hybrid algorithm as a part of implementation stage, the next session results of the optimizing the RNP by the proposed algorithms have been introduced in detail.

## **5.4 Results**

The proposed hybrid artificial intelligence technique has been adopted to optimize the RNP in static and dynamic working areas, and to have better overview of the efficiency of the proposed algorithm the performance of it has been compared with Genetic Algorithm (GA) optimization technique which is a well-known algorithm among evolutionary optimization techniques.

The optimized positions and number of deployed RFID antennas as solution for the RNP has been calculated by both optimization paradigms for 100 iterations with the same first population of possible answers matrix, and the results have been represented and compared as follows.

### **5.4.1 Static Working Area**

As discussed in previous sections the proposed static working area in this thesis is a square room with dimension of  $100 \times 100m^2$  and has been divided to four equal segments. 20 RFID passive static tags have been randomly distributed in this working area. For the first iteration of the optimization process equal to the number of the tags, 20 RFID antennas randomly have been deployed on the network.

The predefined number of deployed antennas by implementing the both optimizing algorithms has been reduced from 20 to 2 at the end of the proposed hybrid optimization process however this number has been calculated as 5 by GA (see figure 41). After optimizing the number of antennas, in the next step coverage and interference of the RFID network which is the resultant of the deployed antennas have been investigated.

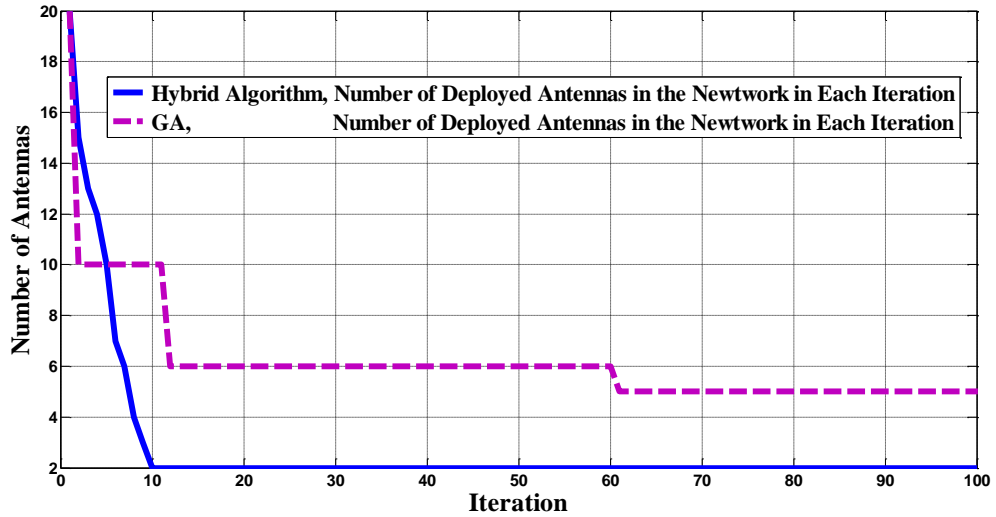

Figure 41: Calculated Number of Deployed Antennas in the Network by the Proposed Hybrid Algorithm and GA in Each Iteration

The results shown in figure 42 indicate that the RFID network coverage at the beginning of both optimizations processes has been calculated as 75%, and both paradigms are capable of improving this percentage to 100%.

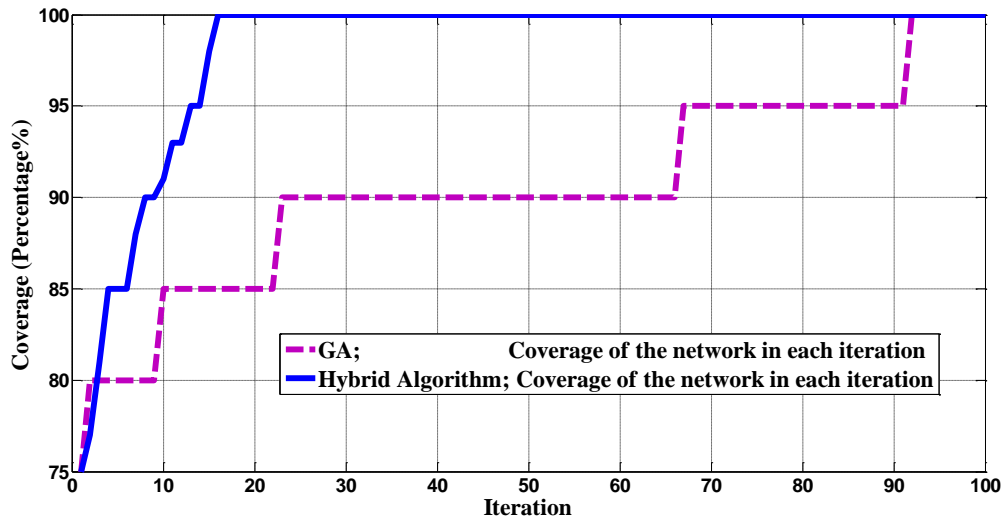

Figure 42: Calculated Coverage of the RFID Network by the Proposed Hybrid Algorithm and GA in Each Iteration

By investigating the network coverage results in detail it can be noticed that however optimizing the RNP utilizing both algorithms gives solutions with full network coverage, but the proposed hybrid artificial intelligence paradigm reaches to the answer in less iterations than GA.

The interference of the RFID network is resultant of collision of the deployed antennas in the network. The ITF of the proposed RFID network from -600 dBm has been reduced to -71.34 dBm and -23.34 dBm respectively by adopting GA and the proposed hybrid artificial intelligence paradigms (see figure 43). Therefore, the network interference results indicate that optimizing the RFID network by the proposed hybrid algorithm compared to GA optimization technique achieves to more efficient number and positions of antennas.

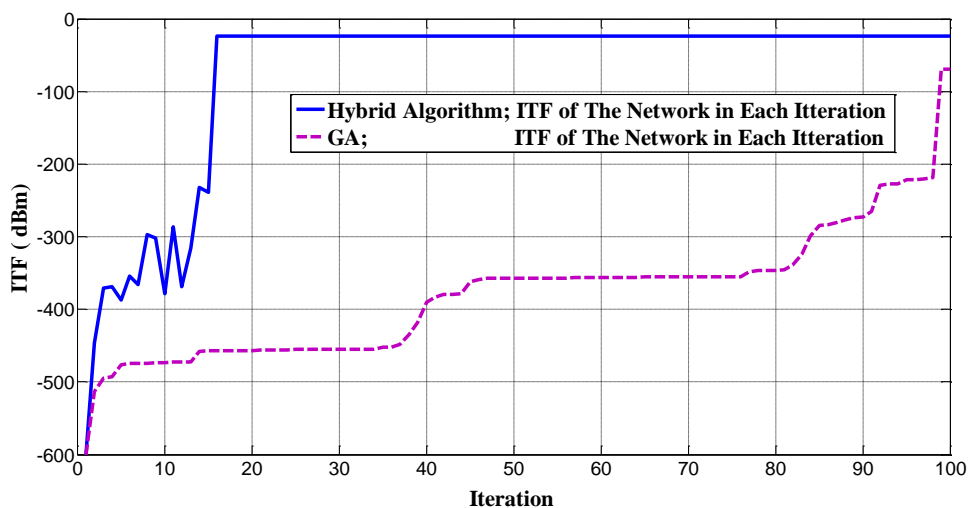

Figure 43: Calculated ITF of the Network by the Proposed Hybrid Algorithm and GA in Each Iteration

Overall, the results indicate that utilizing the proposed hybrid artificial intelligence optimization technique compared to the GA optimization paradigm optimizes the

RFID network and gives a solution to RNP with the fewer antenna and interference in the network.

Comparing the normalized fitness function values of two approaches which has been shown in figure 44 indicated that the proposed hybrid algorithm has superior performance than GA.

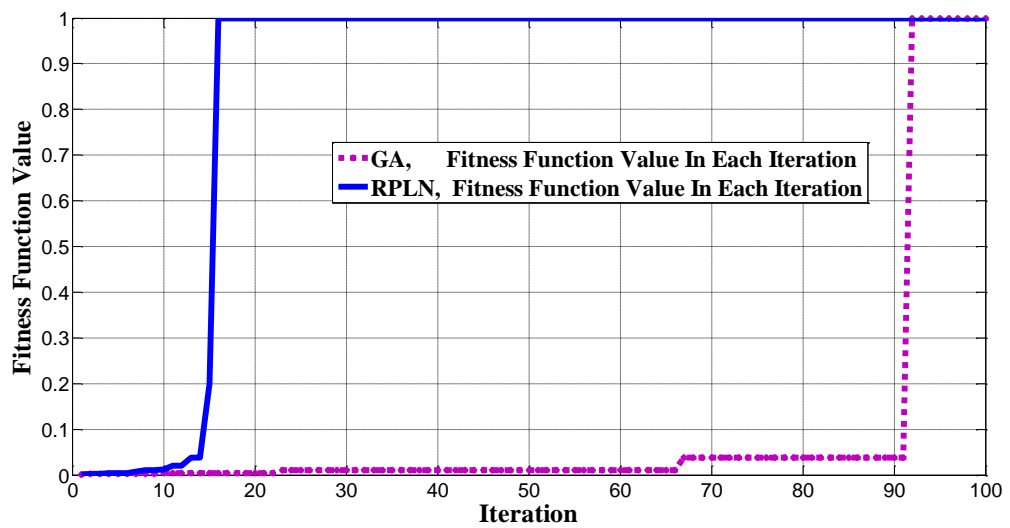

Figure 44: Normalized Fitness Functions Values of the Proposed Hybrid Algorithm and GA in Each Iteration

Since the RFID network can reach full network coverage in fewer iterations due to fewer deployment of antennas and less interference on the network, the proposed hybrid algorithm in compare to GA is more cost effective and time efficient technique. The optimized solution of RNP has been shown in figure 45.

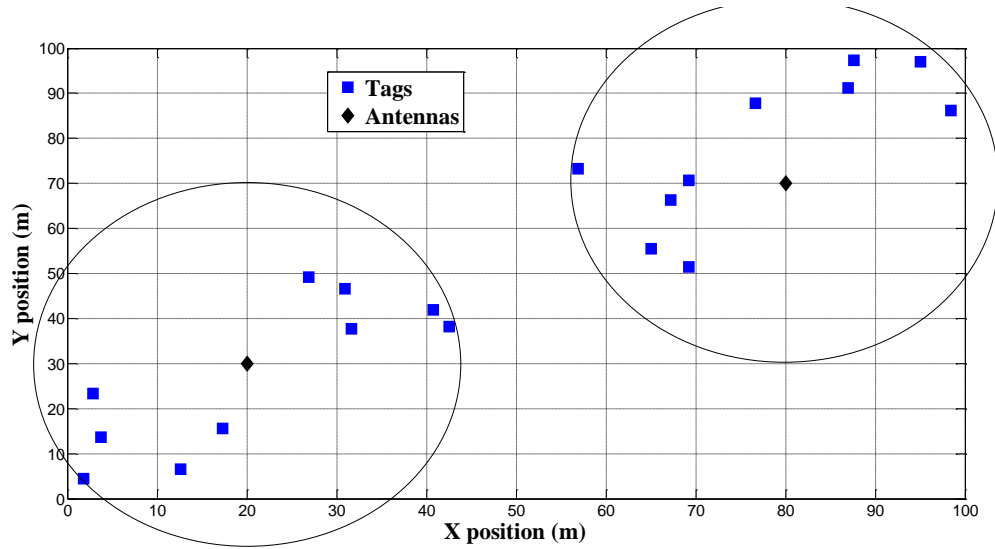

Figure 45: Optimized RFID Network

#### 5.4.2 Dynamic Working Area

As discussed in previous sections the proposed dynamic working area in this thesis is a conveyer belt with dimension of  $3 \times 2 \text{ m}^2$ . 30 RFID passive dynamic tags mounted at the center of moving parts which has been moved along the conveyer with the constant speed of the belt equals to  $0.3 \text{ m/s}$ . For the first iteration of the optimization process equal to the number of the tags, 30 RFID antennas randomly have been deployed on the network.

The predefined number of deployed antennas by implementing the both optimizing algorithms has been reduced from 30 to 1 at the end of the proposed hybrid optimization process however this number has been calculated as 3 by GA (see figure 46). After optimizing the number of antennas, in the next step coverage and interference of the RFID network which is the resultant of the deployed antennas have been investigated.

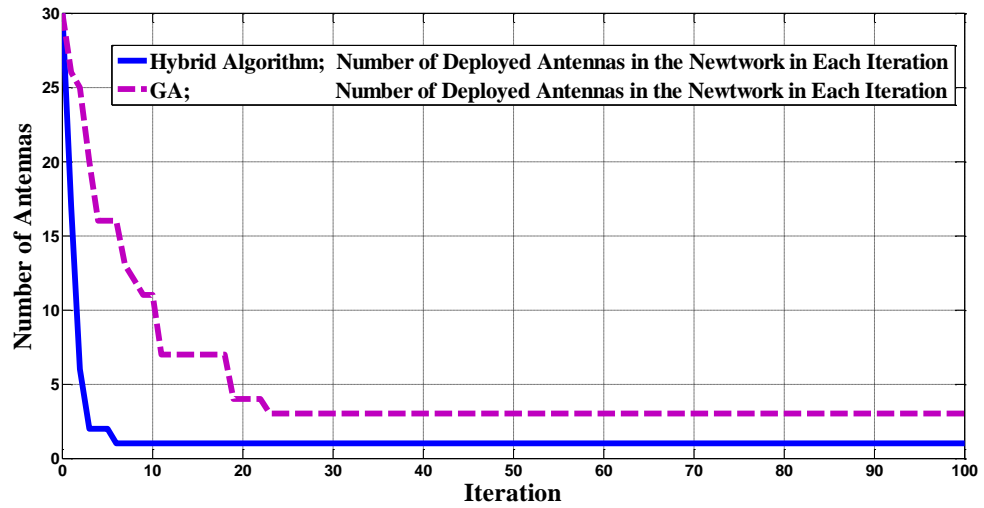

Figure 46: Calculated Number of Deployed Antennas in the Network by the Proposed Hybrid Algorithm and GA in Each Iteration

The results shown in figure 47 indicate that the RFID network coverage remains as 100% from the beginning till the end of the both optimizations processes.

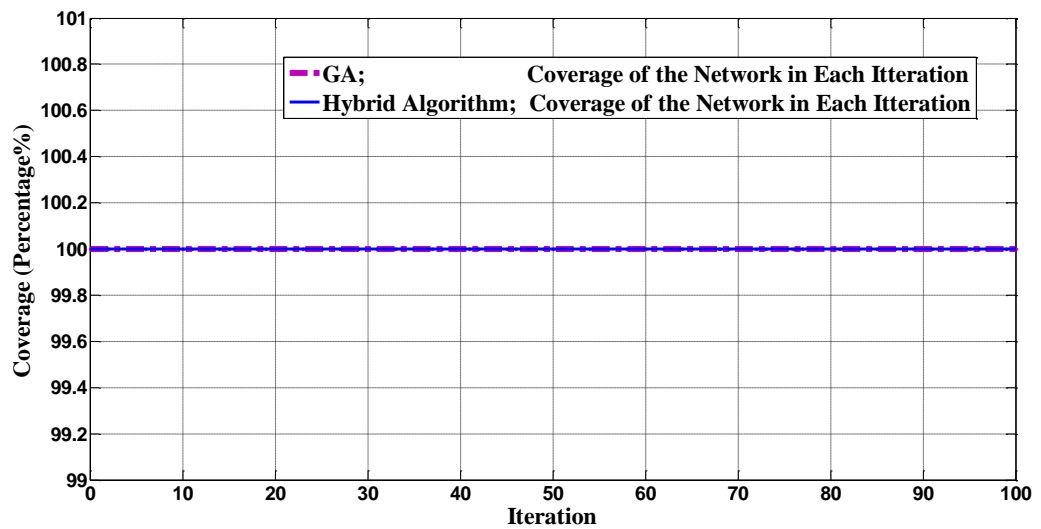

Figure 47: Calculated Coverage of the RFID Network by the Proposed Hybrid Algorithm and GA in Each Iteration

Since network coverage during both optimization processes remains as 100%, then contrary to the proposed static working area investigating the network coverage results does not give a clue to compare the efficiency of the algorithms.

The interference of the RFID network is resultant of collision of the deployed antennas in the network. The ITF of the proposed RFID network from -1000 dBm has been reduced to 0 dBm and -183.66 dBm respectively by adopting GA and the proposed hybrid artificial intelligence paradigms (see figure 48). Therefore, the network interference results indicate that optimizing the RFID network by the proposed hybrid algorithm compared to GA optimization technique achieves to more efficient number and positions of antennas.

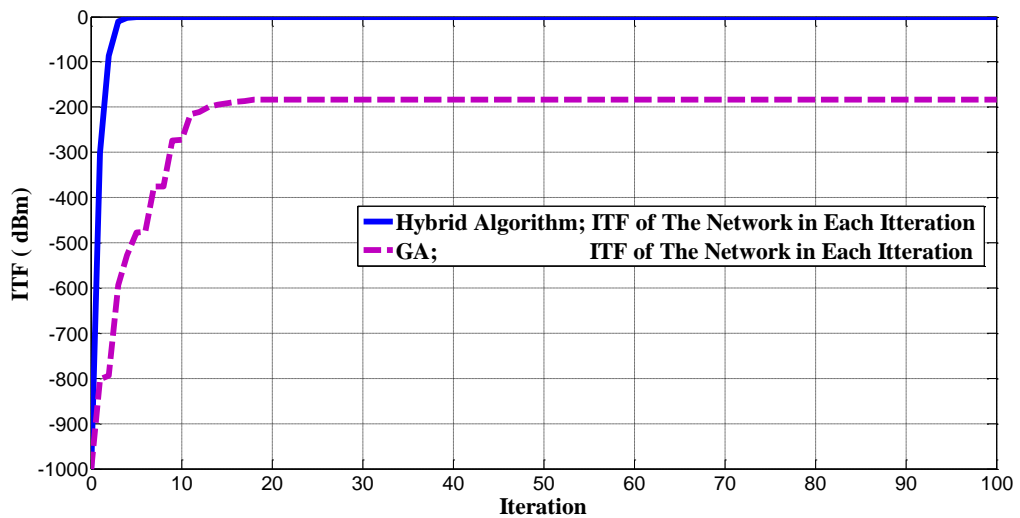

Figure 48: Calculated ITF of the Network by the Proposed Hybrid Algorithm and GA in Each Iteration

Overall, the results indicate that utilizing the proposed hybrid artificial intelligence optimization technique compared to the GA optimization paradigm optimizes the RFID network and gives a solution to RNP with the fewer antenna and interference in the network.



Comparing the normalized fitness function values of two approaches which has been shown in figure 49 indicated that the proposed hybrid algorithm has superior performance than GA.

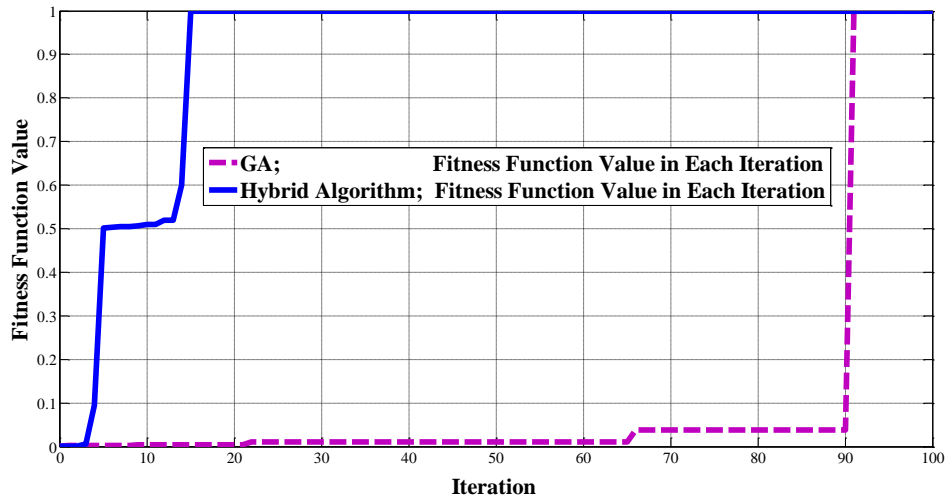

Figure 49: Normalized Fitness Functions Values of the Proposed Hybrid Algorithm and GA in Each Iteration

Since the RFID network can reach full network coverage in fewer iterations due to fewer deployment of antennas and less interference on the network, the proposed hybrid algorithm in compare to GA is more cost effective and time efficient technique. The optimized solution of RNP has been shown in figure 50.

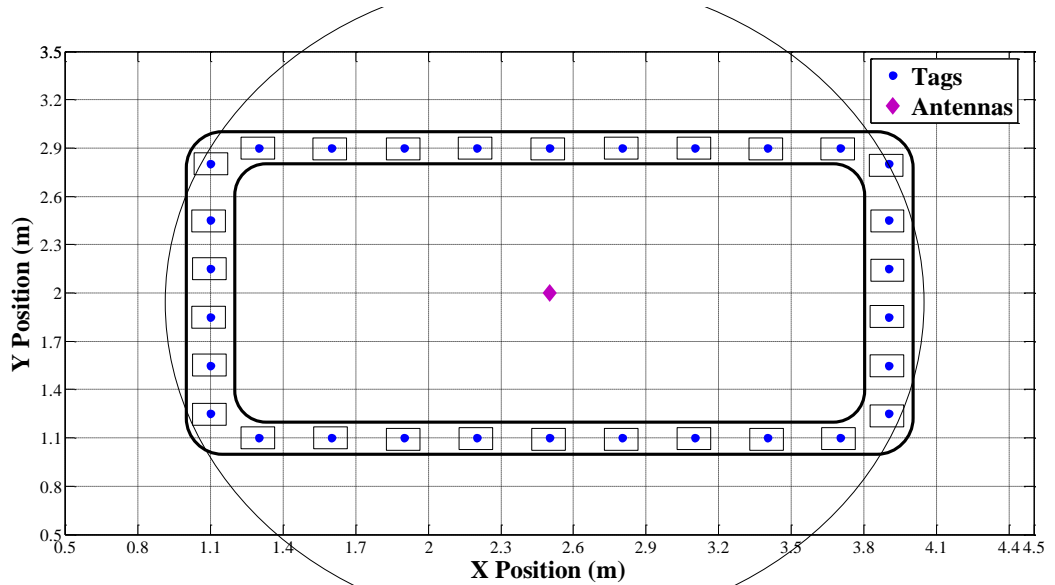

Figure 50: Optimized RFID Network

## 5.5 Conclusion

In this thesis, by combining two optimization paradigms which namely has been known as RPLNN and RAE a novel hybrid artificial intelligence optimization technique introduced as an efficient optimization technique to deal with a complex RFID network planning problems. This proposed optimization technique is capable of adjusting any number of embedded RFID antennas in the network. The simulation based performance assessment has been performed for investigating the effectiveness of the hybrid algorithm over the GA. The simulation results show that the proposed hybrid algorithm has superior performance over the GA. It has been observed that the hybrid optimization technique for optimizing the RNP, is more enhanced than GA as:

1. The proposed hybrid algorithm has faster convergence speed and lesser iterations than GA
2. The proposed hybrid algorithm has less complexity in computations than GA

3. The results given by the proposed hybrid algorithm are more precise and cost effective

In future studies, with an innovation in the proposed mathematical models of the RNP, it will be possible to model an RFID network that involves more criteria such as the quality of the network. A valuable future study would involve the utilization of more optimization techniques for static and dynamic networks to generate RFID networks.

## REFERENCES

- [1] N. Chungoora and R. Young, "The configuration of design and manufacture knowledge models from a heavyweight ontological foundation," *International Journal of Production Research*, p. 4701–4725, 2011.
  
- [2] D. A. GUERRA-ZUBIAGA and R. I. M. YOUNG, "Design of a manufacturing knowledge model," *International Journal of Computer Integrated Manufacturing*, pp. 526-539, 2008.
  
- [3] R. Barenji, M. Hashemipour, A. Barenji and D. Guerra-Zubiaga, "Toward a framework for intra-enterprise competency modeling," in *ACTEA*, Beirut , 2012.
  
- [4] K. Kamioka, E. Kamioka and S. Yamada, "An RF-ID driven holonic control scheme for production control systems," in *International Conference on Intelligent Pervasive Computing*, Berlin, 2007.
  
- [5] Chi-Shih W, Sabah Randhawa and Sheikh Burhanuddin, "An Integration Architecture for Flexible Manufacturing Cells," *Advanced manufacturing technology*, pp. 286-297, 1998.
  
- [6] Chow HKH, Choy KL, Lee WB and Lau KC, "Design of a RFID-case-based resource management system for warehouse operations.," *Expert Syst Appl*, pp. 561-576, 2006.

- [7] Bin Wang, Zilong C, Ying Yan, Weiping Liu and Zheng Wang, "Fundamental technology for RFID-based supervisory control of shop floor production system," *Int J Adv Manuf Technol*, p. 1123–1141, 2011.
- [8] Günther O, Kubach U and Kletti W, FID in manufacturing, Berlin: Springer, 2008.
- [9] Wang JH, Luo ZW and Wong EC, "RFID-enabled tracking in flexible assembly line," *Int J Adv Manuf Technol*, pp. 351-360, 2010.
- [10] McFarlane D, Sarma S, Chirn JL, Wong CY and Ashton K, "Auto ID systems and intelligent manufacturing control," *Eng Appl Artif Inte*, p. 365–376, 2003.
- [11] Liu MR, Zhang QL, Ni LM and Tseng MM, "An RFID based distributed control system for mass customization manufacturing.," *Lect Notes Comput Sci*, p. 1039–1049, 2004.
- [12] R. Abrishambaf , M. Hashemipour and M. Bal, "Structural modeling of industrial wireless sensor and actuator networks for reconfigurable mechatronic systems," *Int J Adv Manuf Technol*, 2012.
- [13] G. Thimm, S. Lee and Y. Ma, "Towards unified modelling of product life-cycles," *Computers in industry*, pp. 331-341, 2005.
- [14] "Unified Modeling Language.," [Online]. Available: <http://www.uml.org>.

- [15] M. M. ., L. M. ., S. C. Tseng, A Collaborative Control System for Mass Customization Manufacturing, *Annals of the CIRP*, 1997.
- [16] Z. Paul, MIT Sloan Management Review, ABI/INFORM Global: Springer, 2001.
- [17] Z. D. ., W. H. H. ., C. Y. P. ., A. W. ., O. S. K. ., F. J. Y. H. a. N. A. Zhou, "A Multi-Agent-Based Agile Scheduling Model for a Virtual Manufacturing," *International Journal of Advanced Manufacturing Technology*, p. 980–984, 2003.
- [18] F. Klaus, "Fundamentals and Applications in Contactless Smart Cards and Identi," in *RFID-Handbook, 2nd edition*, Wiley & Sons LTD, 2003.
- [19] A. N. E. a. M. R. Gunasekaran, "Information technology and systems justification: A review for research and applications," *European Journal of Operational Research*, p. 957–983, 2006.
- [20] D. Johnson, "RFID tags improve tracking, quality on Ford line in Mexico," *Control Engineering*, pp. 11-19, 2002.
- [21] M. a. M. D. Harrison, "White paper on development of a prototype PML server for an auto ID enabled robotic manufacturing environment," [Online]. Available:  
[http://www.ifm.eng.cam.ac.uk/automation/publications/w\\_papers/cam-autoid-](http://www.ifm.eng.cam.ac.uk/automation/publications/w_papers/cam-autoid-)

wh010.pdf. [Accessed Accessed March 2003].

- [22] G. Z. Y. a. J. P. Huang, "RFID-based wireless manufacturing for real-time management of job shop WIP inventories," *International Journal of Advanced Manufacturing Technology*, p. 469–477, 2008.
- [23] Y. J. P. a. H. G. Zhang, "RFID-based smart Kanbans for just-in-time manufacturing," *International Journal of Materials and Product Technology*, p. 170–184, 2008.
- [24] S. e. a. Alejandro, "Tracking of returnable packaging and transport units with active RFID in the grocery supply chain," *Computers in Industry*, pp. 161-171, 2009.
- [25] R. a. S. M. Sikora, "A multi-agent framework for the coordination and integration of information systems," *Management Science*, pp. 65-78, 1998.
- [26] N. a. D. A. Krothapalli, "Design of negotiation protocols for multi-agent manufacturing systems," *International Journal of Production Research*, p. 1601–1624, 1999.
- [27] A. a. B. V. Giret, "From system requirements to holonic manufacturing system analysis," *International Journal of Production Research*, p. 3917–3928, 2006.
- [28] M. e. a. Weng, "Multi-agent-based workload control for make-to-order

manufacturing," *International Journal of Production Research*, p. 2197–2213, 2008.

[29] I. Satoh, "Location-based services in ubiquitous computing environments," *International Journal on Digital Libraries*, p. 280–291, 2006.

[30] F. C. G. a. G. D. Bellifemine, *Developing multi-agent systems with JADE*, USA: John Wiley & Sons, 2006.

[31] M. D. Y. a. F. D. Shafiq, "Bridging multi agent systems and web services: Towards interoperability between software agents and semantic web services," in *Proceedings of the 10th IEEE international enterprise distributed object computing conference (EDOC 2006)*, Washington, USA. New Jersey, 2006.

[32] D. e. a. Tapia, "a SOA-based multi-agent architecture," *Advances in Soft Computing Series*, pp. 99-107, 2009.

[33] Hashemipour M, Erenay, O. and Kayaligil, S, "Virtual reality in requirement analysis for CIM system development suitable for SMEs," *Production research*, pp. 1-16, 2002.

[34] L. Na, Z. Zhiyuan and T. Jie , "Monitor and Control System with RFID Technology in Discrete Manufacturing Line," in *International Conference on RFID-Technology and Applications*, Guangzhou, China, 2010.



- [35] Kai-Ying Chen, "Cell controller design for RFID based flexible manufacturing systems," *International Journal of Computer Integrated Manufacturing*, pp. 35-50, 2012.
- [36] Hashemipour M, Erenay, O. and Kayaligil, S, "irtual reality in requirement analysis for CIM system development suitable for SMEs," *Production research* , pp. 1-16, 2002.
- [37] Z. C. a. R. M. Huibin Sun, "Monitoring and controlling the complex product assembly executive process via mobile agents and RFID tags," *Assembly Automation*, pp. 263-271, 2009.
- [38] A. R. D. M. D. Brintrup, "RFID opportunity analysis for leaner manufacturing," *International Journal of Production Research*, pp. 2745-27-64, 2010.
- [39] D. A. Guerra-Zubiaga and R. I. M. Young, "Design of a manufacturing knowledge model," *International Journal of Computer Integrated Manufacturing*, pp. 526-539, 2008.
- [40] R. S. & T. M. A. Chen, "Development of an agent-based system for manufacturing control and coordination with ontology and RFID technology," *Expert Systems with Applications*, pp. 7581-7593, 2009.
- [41] Z. X. W. W. K. e. a. Guo, "Intelligent production control decision support system for flexible assembly lines," *Expert Systems with Applications*, pp. 4268-

4277, 2009.

- [42] H. F. Manesh and M. Hashemipour, "Virtual-reality-based methodology for modelling and verifying shop floor control systems," *Proc. ImechE Part B: J. Engineering Manufacture*, pp. 1251-1265, 2010.
- [43] R. G. Qiu, "RFID-enabled automation in support of factory integration," *Robotics and Computer-Integrated Manufacturing*, pp. 677-683, 2007.
- [44] S. Y. Chang, D. C. Li and T. L. Chen, "Using an electronic product code network to improve monitoring systems for continuous operating equipment — a thermal power plant example," *Proceedings of the Institution of Mechanical Engineers, Part B: Journal of Engineering Manufacture*, pp. 1437-1445, 2010.
- [45] P. Y. Jiang, Q. Q. Zhu and M. Zheng, "Event-driven graphical representative schema for job-shop-type material flows and data computing using automatic identification of radio frequency identification tags," *Proceedings of the Institution of Mechanical Engineers, Part B: Journal of Engineering Manufacture*, pp. 339-352, 2012.
- [46] V. Singh and V. P. Agrawal, "Structural modelling and integrative analysis of manufacturing systems using graph theoretic approach," *Journal of Manufacturing Technology Management*, pp. 844-870, 2008.
- [47] Ruey-Shun Chen, Mengru Arthur Tu and Jung-Sing Jwo, "An RFID-based

enterprise application integration framework for real-time management of dynamic manufacturing processes," *Int J Adv Manuf Technol*, pp. 1217-1234, 2010.

[48] Robin G. Qiu, "RFID-enabled automation in support of factory integration," *Robotics and Computer-Integrated Manufacturing*, pp. 677-683, 2007.

[49] D. A. Guerra-Zubiaga and R. I. Young, "Design of a Manufacturing Knowledge Model," *International Journal of Computer Integrated Manufacturing* , pp. 526-539, 2008.