

A Novel Multi-Agent Based Agile Manufacturing Planning and Control System

Ali Vatankhah Barenji

Submitted to the
Institute of Graduate Studies and Research
in partial fulfillment of the requirements for the degree of

Doctor of Philosophy
in
Mechanical Engineering

Eastern Mediterranean University
December 2016
Gazimağusa, North Cyprus

Approval of the Institute of Graduate Studies and Research.

Prof. Dr. Mustafa Tümer
Director

I certify that this thesis satisfies the requirements as a thesis for the degree of Doctorate of Philosophy in Mechanical Engineering.

Assoc. Prof. Dr. Hasan Hacışevki
Chair, Department of Mechanical Engineering

We certify that we have read this thesis and that in our opinion it is fully adequate in scope and quality as a thesis for the degree of Doctorate of Philosophy in Mechanical Engineering.

Prof. Dr. Majid Hashemipour
Supervisor

Examining Committee

1. Prof. Dr. Murat Bengisu
2. Prof. Dr. Mine Demirsoy
3. Prof. Dr. Fuat Egelioglu
4. Prof. Dr. Majid Hashemipour
5. Assoc. Prof. Dr. Hasan Hacışevki

ABSTRACT

In the last decades, significant changes in the manufacturing environment have been noticed: moving from a local economy towards a global economy, with markets asking for products with high quality at lower costs, highly customized and with short life cycle. In this environment, the manufacturing enterprises, to avoid the risk to lose competitiveness, search to answer more closely to the customer demands, by improving their flexibility and agility, while maintaining their productivity and quality. Actually, the dynamic response to emergence is becoming a key issue, due to the weak response of the traditional manufacturing systems to unexpected disturbances, mainly because of the rigidity of their control architectures.

In these circumstances, the challenge is to develop manufacturing control and scheduling systems that have autonomous and intelligence capabilities, fast adaptability to the environmental changes, higher robustness against the occurrence of disturbances, and is able to be easily integrated with manufacturing resources and legacy systems. Currently, several architectures using emerging concepts and technologies have been proposed, in particular those based on the agent based manufacturing paradigm. Agent technology has been recognized as a promising paradigm for the next generation manufacturing systems. Researchers have even attempted to apply agent technology to manufacturing enterprise integration, enterprise collaboration (including supply chain management and virtual enterprises), manufacturing process planning and scheduling, shop floor control, and to holonic manufacturing as an implementation methodology.

This dissertation intends to develop an agile and adaptive manufacturing control and scheduling system for tackling the current requirements imposed in the manufacturing enterprises. In order to meet the objective of this thesis, the following sub goal has been developed; the first sub goal is to study the design and develop a new agent based manufacturing system for a more realistic deployment in factories by taking into consideration both the machine disturbances and customer demand. The proposed agent based manufacturing system uses flexible flow line manufacturing system (UPVC door and window) as its case study and then validates it in the company. The second sub goal of this study with regards to lack of self-organization of the agent-based system in the manufacturing system is to improve the self-organization mechanism in the agent-based system by utilizing the ant colony approach. The proposed self-organization mechanism implements the reference architecture (RFID based multi agent manufacturing system) at flexible manufacturing system. The implementation of these kinds of manufacturing system in a real factory is very costly and risky also existing simulation platforms are not efficient enough to cover the implementation schema. Therefore, the last goal of this study is to design and develop an effective simulation platform for an agent based manufacturing system. The proposed simulation platform is explained based on the flexible assembly line company. All proposes systems are implemented in the proposed simulation platform and real scenarios are defined for the validation and verification of the proposed system. The achieved simulation and experimental results show an improvement of in key performance indicators.

Keywords: multi agent system, simulation, control and scheduling, agile manufacturing, re-configurability

ÖZ

Son yıllarda, imalat alanında önemli gelişmeler meydana gelmiştir. Yerel ekonomiden küresel ekonomiye doğru ilerleme ile birlikte pazarlarda düşük maliyetli, yüksek oranda özelleştirilmiş, yüksek kaliteli fakat kısa ömürlü ürünlerin talep edildiği gözlemlenmiştir. Bu ortamda, imalat şirketleri, rekabet gücünü kaybetme riskinden kaçınmak için verimliliklerini ve kalitelerini koruyarak esnekliği ve çevikliği arttırmaya yönelik çalışmalar yaparak müşteri taleplerine daha tatminkar cevaplar bulmak ve ortaya çıkan sonuçlar ile geleneksel imalat sistemlerinde beklenmedik problemlere yanıt olması bakımından kilit bir konu haline gelmiştir.

Bu bağlamda, özerklik ve istihbarat özellikleri, çevre değişikliklerine hızlı adaptasyon, bozuklukların ortaya çıkmasına karşı sağlamlık, imalat kaynaklarının ve eski sistemlerin kolaylaştırılmış entegrasyonu ile üretim kontrol ve zamanlama sistemleri geliştirilmesi amaçlanmıştır. Ortaya çıkan kavramları ve teknolojileri kullanan, özellikle temel üretim bulgusuna dayanan birkaç mimari kavram önerilmiştir. Agency teknolojisi, gelecek nesil üretim sistemleri için umut verici bir bulgu olarak kabul edilmiştir. Araştırmacılar, imalat entegrasyonu, tedarik zinciri yönetimi ve sanal işletmeler dahil olmak üzere kurumsal işbirliği, üretim planlama ve çizelgeleme, atölye kontrolü ve bir uygulama metodolojisi olarak holonik imalatında acenta teknolojisini uygulamaya teşvik edilmiştir.

Bu çalışma, imalat işletmelerinde uygulanan mevcut şartlarda, çevik ve uyarlanabilir üretim kontrolü ve çizelgeleme sistemi geliştirmeyi amaçlamaktadır. Tezin amacını açıklamak için aşağıdaki hedefler geliştirilmiştir; ilk hedef, makine arızasını ve

müşteri talebini göz önüne alarak fabrika için yeni bir acenta tabanlı imalat sistemi tasarlamak ve geliştirmektir. Geliştirilen Agency tabanlı imalat sistemi, bir analiz çalışması olarak sunulup, üretim sistemi (UPVC kapı ve pencere) olarak kullanılmış ve şirket tarafından onaylanmıştır. Bu çalışmada, çoklu agency sistemlerinin imalat sisteminde kendi kendine adaptasyonuna ilişkin ikinci hedef, karınca koloni yaklaşımını kullanarak çoklu acenta sistemi üzerinde kendi kendini düzenleme mekanizmasını geliştirerek adaptasyonu kendi kendine yapması sağlanmaktadır. Geliştirilen otomatik adaptasyon mekanizması, analiz sistemlerinin imalatında referans mimariyi (RFID tabanlı çok etmen imalat sistemi) uygulamıştır. Bu tür bir imalat sisteminin gerçek fabrikada uygulanması çok masraflı ve mevcut simülasyon platformu bulutunun riskli olması da uygulama şemasını etkin şekilde kapsamamaktadır. Bu nedenle bu çalışmanın diğer bir hedefi ise, çoklu acenta sistemi imalatı için etkili simülasyon platformunun tasarlanması ve geliştirilmesidir. Geliştirilen simülasyon platformu, değişken montaj hattı şirketi ile bağlantılı olarak açıklanmıştır. Geliştirilen sistemlerin tümü önerilen simülasyon platformunda uygulanmaktadır. Ek olarak, gerçek senaryolar önerilen sistemin doğrulanması için tanımlanmıştır. Elde edilen simülasyon ve deneysel verilere göre, ana performans göstergelerinde de bir iyileşme olduğu gösterilmiştir. Beklenen hedef, düşük maliyetli ve düşük uygulama riski göz önüne alınarak daha çevik bir üretim sistemi tasarlayan ve geliştiren bu çalışmanın asıl amacını oluşturmuştur.

Anahtar Kelimeler: çoklu agency sistemi, simülasyon, kontrol ve planlama, çevik üretim, yeniden yapılandırılabilirlik

To My Family

ACKNOWLEDGMENT

This work is the result of several collaborations with the industrial and academic worlds. In this respect, I would like to express my special appreciation and thanks to mechanical department staff of Eastern Mediterranean University. I would like to thanks to my advisor. I would like to appreciation and thanks my committee members, Prof. Dr. Murat Bengisu, Prof. Dr. Mine Demirsoy, Prof. Dr. Fuat Egelioglu, and Assoc. Prof. Dr. Hasan Hacısevki for serving as my committee members even at hardship. I also want to thank you for letting my defense be an enjoyable moment, and for your brilliant comments and suggestions, thanks to you.

A special thanks to my family and Raheleh. Words cannot express how grateful for all of the sacrifices that you are made on my behalf.

TABLE OF CONTENTS

ABSTRACT.....	iii
ÖZ.....	v
ACKNOWLEDGEMENT	viii
LIST OF TABLES.....	xii
LIST OF FIGURES	xiii
1 INTRODUCTION	1
1.1 Introduction	1
1.2 Research Problems	3
1.3 Research Aims and Objectives.....	5
1.4 Research Framework.....	6
1.5 Organization of Thesis	8
2 LITERATURE REVIEW	12
2.1 Introduction	12
2.2 Manufacturing system	15
2.2.1 Classification of Manufacturing Systems.....	17
2.2.2 Technologies in Manufacturing Systems.....	25
2.2.3 Flexibility and Agility in Manufacturing Systems	26
2.2.4 Agility in Manufacturing System	29
2.3 Flexible Manufacturing Systems.....	31
2.4 Computer Integrated Manufacturing	32
2.5 Industry 4.0.....	33
2.6 Manufacturing Control and scheduling Paradigms	34
2.6.1 Production scheduling and Manufacturing Control.....	34

2.7 Multi agent system	40
2.7.1 Agent communication languages.....	43
2.7.2 Ontologies.....	43
2.8 Agent based Manufacturing System	44
2.8.1 Simulation of Agent-Based Systems	45
2.8.2 Agent-Based Modelling and Simulating Environments	47
2.8.3 Existing agent based manufacturing scheduling and control system	48
2.9 RFID-Multi Agent Manufacturing System	49
2.9.1 Design and Development phase	51
2.9.2 Verification layer	55
2.9.3 Implementation Phase.....	56
2.10 Limitations and Challenges of the Existing Approaches	59
2.11 Summary	60
3 DESIGN AND DEVELOP A NOVEL AGENT BASED AGILE SYSTEM	61
3.1 Overview	61
3.2 Introduction	61
3.3 Prometheus methodology	65
3.3.1 Case study and design of the proposed multi-agent system	67
3.3.2 System specification design.....	68
3.3.3 Architecture design.....	70
3.3.4 Detailed design	72
3.4 Implementation.....	75
3.6 Summary	77
4 IMPROVING SELF-ORGANIZATION OF AN AGENT BASED SYSTEM	79
4.1 Overview	79

4.2 Introduction	80
4.3 Design of RFIDMAMs with Indirect Coordination Mechanism	83
4.3.1 Ant agent for station level.....	85
4.3.2 Ant agent for shop level.....	88
4.5 Summary	88
5 SIMULATION PLATFORM FOR IMPLEMENTING MASs.....	90
5.1 Overview	90
5.2 Introduction	90
5.3 Simulation Platform	91
5.4 Case Study.....	96
5.4.1 Station and shop level CPN models in case study.....	97
5.4.2 Sensor level.....	100
5.4.3 Agent negotiations in FAL	100
5.5 Summary	101
6 RESULT AND DISCUSSION	103
6.1 Overview	103
6.2 Performance indicators.....	103
6.3 Result of UPVC Company	104
6.4 Result of Flexible Assemble Line Company.....	110
6.5 Result of Ant agent based MAS	113
7 CONCLUSION	118
REFERENCES.....	122

LIST OF TABLES

Table 1: Summary of information of each chapter regarding methodology.....	8
Table 2: Comparison of new paradigms in manufacturing system.....	23
Table 3: Summary of some of the most important ABM tools[73].....	48
Table 4: Mapping Prometheus modeling concepts into JACK concepts.....	76
Table 5: Code generation.....	85
Table 6: XML code for description of agent	92
Table 7: Impact factor for calculation number of sequences.....	97
Table 8: Customer demand for July month in YBG company	99
Table 9: Result of simulation and conventional system for customer demand	100
Table 10: Summary of lead time for UPVC company.....	102
Table 11: Summary of throughput for UPVC company.....	102
Table 12: Summary of resource utilization for UPVC company.....	102
Table 13: Summary of lead time for FAL.....	104
Table 14: Summary of throughput for FAL.....	104
Table 15: Summary of resource utilization for FAL.....	105
Table 16: Summary of lead time for Ant agent based MAS.....	109
Table 17: Summary of throughput for Ant agent based MAS.....	110
Table 18: Summary of resource utilization for Ant agent based MAS.....	111

LIST OF FIGURES

Figure 1: Overall Framework.....	7
Figure 2: IT structure of manufacturing factory	14
Figure 3: Components of Manufacturing System	16
Figure 4: impact of IT components.....	16
Figure 5: classification of manufacturing system	18
Figure 6: production paradigm[23]	21
Figure 7: The structure of agile manufacturing[32]	24
Figure 8: FMS by considering the three basic component [46].....	32
Figure 9: all types of revolution in industries	33
Figure 10: classification of manufacturing control system[54]	38
Figure 11: generic software agent inspired by[2]	41
Figure 12: structural modeling for designing RFIDMAMs	49
Figure 13: the connections and hierarchical relationships of the FMS.....	51
Figure 14: Shop human/machine interface	52
Figure 15: Class diagram of the system	52
Figure 16: UML sequence diagram of assembling station	53
Figure 17: Activity diagram of the system.....	54
Figure 18: sequence diagram of RFID gate	55
Figure 19: Verification layer.....	56
Figure 20: message structure of FIPA-ACL	57
Figure 21: Multi agent system architecture of RFIDMAMs	58
Figure 22: Design steps of the PM [114]	65
Figure 23: Layout of the manufacturing MFL of YBG	68

Figure 24: Goal overview diagram of the system.....	69
Figure 25: System role overview	70
Figure 26: System overview diagram in the architectural design stage.....	71
Figure 27: Negotiation between Cell Agent and Scheduler Machine Agent.....	72
Figure 28: Manager Agent architecture	73
Figure 29: Detailed Design of cell agent	73
Figure 30: Detailed design of scheduler machine agent	74
Figure 31: Sequence diagram of decision-making mechanism	75
Figure 32: Code generation process.....	76
Figure 33: Illustrated indirect communication in food foraging ant colony	82
Figure 34: UML Class diagram of configuration of proposed mechanism	84
Figure 35: Proposed RFID MACS with IDCM	85
Figure 36: Sequence diagram of agent collaboration when decision of SCA is accepted	86
Figure 37: Sequence diagram of agent collaboration when decision of SCA is rejected	87
Figure: 38 XML schema configuration of ant agent for shop level.....	88
Figure: 39 RFIDMAMs architecture with HA.....	92
Figure: 40 Sequence diagram for new task initiation in RFIDMAMs.....	93
Figure: 41 Simulation test platform architecture	94
Figure: 42 Flexible assembly system layout	96
Figure: 43 CPN model of multi process machine	98
Figure: 44 System level model	99
Figure: 45 Sensor level model	100
Figure: 46 Agent negotiations.....	101

Figure: 47 Summary of the experimental results 116

Chapter 1

INTRODUCTION

1.1 Introduction

In the last decades, one of the major driver of the world economy has been the manufacturing sector; however, it has been suffering from a revolution, when considering the customers perception. This is being propagated by the growing demand for higher products customization, quality standardization and by the decrease in the product life cycle, which is illustrated by notable variations in marketplace demands[1]. A change in the manufacturing industry instigating the shift from mass production to mass customization. In fact, this change is highly noticeable: moving from a local economy towards a global economy, with markets demanding for products with high quality at lower costs, highly customized and with short life cycle, leading to mass customization. In parallel, the continuous evolution of technology often requires the updating and integration of existing systems within new supervisory environments, to avoid their technological obsolescence.

Today's marketplace is increasingly becoming more demanding in terms of lower costs, faster time-to-market, and better quality, thus forcing companies to become ever more reactive and agile in performing their daily business management tasks. Some manufacturing industries have founded their businesses on shorter life-cycle products or have diversified into more competitive markets in different industrial sectors. The most direct implication of this evolution is that modern manufacturing companies

should be able to act like cells in an organism (the market). In simple terms, the business model is changing from an open competition to one in which, for the organism to survive, strong, effectively linked cooperation among businesses horizontally and vertically is fundamental[2].

With the advent of the postindustrial age, the survival of manufacturing companies has become increasingly more dependent on their ability to react promptly and flexibly to market variations and needs. In this respect, flexibility would appear to be major strategic success factor for satisfying the global competition needs of the worldwide manufacturing enterprises, allowing them to provide high-quality products at reasonable costs. Modern production systems must be distinguishable by their organization of management, communication, and production tasks, as well as by planning and decision capabilities, which allow them to rapidly respond to (or better, to predict) market needs, while still effectively competing within market[3].

Today's flexibility and reconfigurable of manufacturing systems was improved by using computer integrated manufacturing (CIM), one realistic example is the flexible manufacturing system (FMS), which is an automated manufacturing system, however FMS consists of a centralized database for product data model (PDM) and manufacturing data model(MAM). The PDM is an information model that holds information relating to manufacturing facilities, which is needed for the product manufacturing. PDM and MDM provides an optimal scheduling plan for manufacturing control system in a centralized way[4]. Centralized control system is an effective mass production scheme in which, the product variety is low and the volume of the product does not change so much[5]. However, the centralized control and scheduling system is not flexible or agile for mass customization. Furthermore,

the reconfiguration of this system is not accepted in mass customization. Therefore, deploying a centralized control system is no longer feasible for mass customization mode, and so today's distributed control and scheduling approaches have been suggested as a solution by many researchers. Early works, appearing from the 1990s, started to introduce the auction-based distributed control mechanisms in the manufacturing applications. Recently, multi-agent systems (MASs) for resolving centralized manufacturing control problems have drawn wide interest in many literatures[6]. MASs provide more flexibility and quicker reactions to the control systems when taking into account a dynamically changing environment.

1.2 Research Problems

In the global competitive markets, the manufacturing enterprises require methods and implementation measures, by which the agility and re-configurability requirements can be fully satisfied, in order to cope with various disturbances and the varying demand of the market. Furthermore, paradigms and technologies improve flexibility and agility while still maintaining its productivity and quality.

The agility and flexibility are related to its capability of adaptation to the stochastic and volatile manufacturing environment. These competitiveness vectors require the ability to maintain goals in face of internal and external unpredictable disturbances. The weak reaction to disturbances, with new jobs arriving, certain resources becoming unavailable and additional resources being introduced to the system, leads to deviations from the initial plans and causes delays and non-operative situations.

In the past decade, several methods and technologies have been employed in order to improve the responsiveness of the manufacturing enterprises, such as the FMS and

CIM system. these technologies have been very useful, especially in improving manufacturing, design and cooperation, supporting changes in the production schedules, automated manufacturing and assembly operations, enhancing product service, repair and providing adequate vehicles for manufacturing training.

The research and experience in the field of manufacturing have shown that the traditional manufacturing control systems do not exhibit this capability of adaptation and evolution in terms of production control. In fact, the centralized and hierarchical control approaches present good production optimization but show a weak response to change; this is mainly because of the rigidity and centralization of the control structure. On the other hand, decentralized manufacturing approaches provide a good response to changes and unpredictable disturbances that occur, however due to the partial knowledge of the system, global production optimization maybe degraded.

The Decentralized Manufacturing System (DMS) has been suggested as a solution for the agile manufacturing system[8]. The DMS is designed based on a multi agent system, structures by means of cooperating intelligent entities to organization manufacturing activities, as a result this technology is able to meet the re-configurability, scalability, agility, and fault tolerant requirements of the manufacturing system[9]. The DMS is basically an intelligent manufacturing paradigm, that is fully capable of overcoming many difficulties that is faced by the existing conventional, rigid control system[10].

One promising approach in this context is the MAS, which has been endorsed by many researchers as an acceptable tool and method for designing and developing DMS [2, 11]. MAS is a computerized system that advocates the design of systems based on the

societies of decentralized, distributed, autonomous and intelligent entities, called agents. Intelligence may integrate some methodical, functional, procedural approach, algorithmic search or reinforcement learning. In such systems, every agent has a partial view of its surrounding world and must therefore cooperate with others in order to achieve the overall global objectives. The behavior of the global system emerges from the cooperation that exist between individual agents.

In spite of its promising perspective and the research developed by the MAS, the agent based manufacturing achievements leave some important open questions: how to design and develop agent based manufacturing system based on the standard methodology, how to achieve global optimization in decentralized systems, how to introduce learning and self-organization capabilities, how to evaluate proposed systems, how to take into account the customer demand on the system, etc.

1.3 Research Aims and Objectives

The aim of this research is to explore and investigate the idea behind the agent based agile manufacturing system as well as design a novel agent based scheduling and control system by considering all types of disturbances that can occur.

To achieve this aim, the major objectives of the research is stated as follow:

- Carrying out investigation on the difficulties that confront the current control and scheduling architecture of the existing system, which can be potentially improved by the proposed idea.
- Designing a system based on the standard methodology.
- Developing a suitable self-organization mechanism in the agent-based system for improving the performance of the whole system.

- Developing a simulation platform for implementing the proposed system in a risk-free environment.

The research question behind the thesis are as follows;

- How will agent technology contribute to the development of an agile manufacturing system with respect to all of its major aspects?
- How will you model an agent based agile manufacturing system with standard purpose methodologies?
- How will the implement and simulation of the agent based agile manufacturing system?
- How will improve the performance of the existing agent based agile manufacturing system?

Several methodologies and simulation software have been proposed in this thesis for designing, developing and implementing agent based agile manufacturing system in the SMEs. The proposed simulation platform used color petri net tools for describing hardware level and integration between hardware level and software level established.

1.4 Research Framework

The aim of this thesis is to develop an agile manufacturing system that is surrounding by three sub goals, to arrive at these goals we utilized and engineering design process framework for every single goal. This framework is illustrated in Fig1. There are three phases that exist for our framework. Firstly, an initial phase that consist of the problem's definition, the background research focus on the existing methodologies and lacks of these methodologies or solution and specific requirements such as process

requirement, functional requirement, etc. The second phase is the design and development phase, which consist of brainstorm, preliminary system design, prototype of the system, system design and detail design and then the system verification. They are connected to gather in other to improve the design and development process. The last phase is implementation phase, which focuses on the implementation of the software, hardware and communication or integration parts.

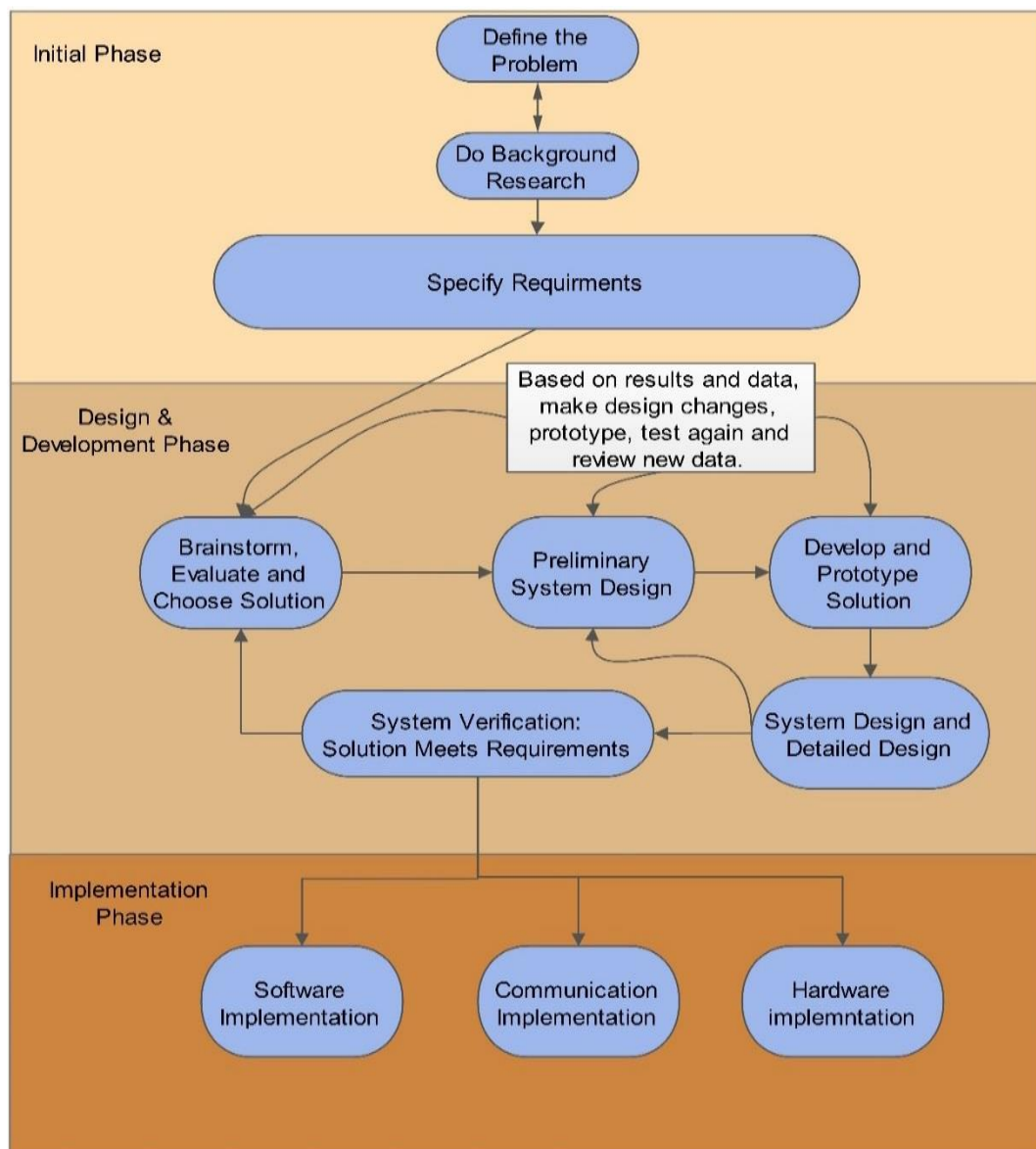

Figure 1: Overall Framework

The summary of the information of each chapter is defined in Table 1.

Table 1: summary of the information of each chapter regarding this framework

Chapters	Initial phase	Design & development	Implementation
Designing a novel system	Lack of standard design	Design and developed system based Prometheus methodology	Jack used for software implementation and petri net tool 4. Used for hardware implementation.
Improvement of the self-organization of multi agent system	Need to improve self-organization and optimization process.	Design indirect mechanism system based on ACI	JADE used for software development, JESS used IDCM
Simulation platform	Existing Simulation platform are not sufficient for manufacturing system, they are lack of real time simulation of a hardware and software.	Hybrid agent based simulation platform	The proposed system in implemented in the JADE platform and petri net tool4. Communication based on XML.

1.5 Organization of Thesis

The rest of this thesis is organized as following; chapter 2 is literature review of manufacturing system, it is focus on definition of manufacturing system and classification of manufacturing system, old and new approaches in the manufacturing system is explained, after that centralized and distributed manufacturing control and schooling is explained, and existing agent based agile manufacturing system, chapter 3 proposed a novel agent based agile manufacturing system by considering both machine disturbance and customer demand, by considering flexible flow line manufacturing system as a case study, chapter 4 focused on the improving of the proposed multi agent based manufacturing system and proposed novel self-organization in the multi agent system based on ant colony in this chapter RFIDMAMs is used as reference architecture and flexible flow line manufacturing system as case study for verification on the proposed system, chapter 5 proposed simulation platform

for implementing agent based agile manufacturing system in the simulation environment, this simulation platform is explained based on flexible assemble line manufacturing system, chapter 6 is results and discussion part of this thesis and chapter 7 highlighted future work and existing limitation.

The results of this dissertation are published (or submitted for publication) in a number of journals or presented in international conferences. These publications are listed below for different chapters.

Chapter 2

1. Barenji, Reza Vatankhah, Ali Vatankhah Barenji, and Majid Hashemipour. "A multi-agent RFID-enabled distributed control system for a flexible manufacturing shop." *The International Journal of Advanced Manufacturing Technology* 71, no. 9-12 (2014): 1773-1791.
2. Barenji, Ali Vatankhah, Reza Vatankhah Barenji, and Majid Hashemipour. "A framework for structural modelling of an RFID-enabled intelligent distributed manufacturing control system." *South African Journal of Industrial Engineering* 25.2 (2014): 48-66.
3. Barenji, Ali Vatankhah, Reza Vatankhah Barenji, and Majid Hashemipour. "Structural modeling of a RFID-enabled reconfigurable architecture for a flexible manufacturing system." *Smart Objects, Systems and Technologies (SmartSysTech), Proceedings of 2013 European Conference on. VDE, 2013.*

Chapter 3

4. Barenji, Ali Vatankhah, Reza Vatankhah Barenji, and Majid Hashemipour. "Flexible testing platform for employment of RFID-enabled multi-agent system on flexible assembly line." *Advances in Engineering Software* 91 (2016): 1-11.
5. Barenji, Ali Vatankhah Shaygan, Amir, and Reza Vatankhah Barenji. "Simulation Platform for Multi Agent Based Manufacturing Control System Based on The Hybrid Agent." *arXiv preprint arXiv:1603.07766* (2016).

Chapter 4

6. Barenji, Ali Vatankhah, Reza Vatankhah Barenji, Danial Roudi, and Majid Hashemipour. "A dynamic multi-agent-based scheduling approach for SMEs." *The International Journal of Advanced Manufacturing Technology* (2016): 1-15.
7. Adetunla, Adedotun Olanrewaju, Ali Vatankhah Barenji, and Reza Vatankhah Barenji. "Developing manufacturing execution software as a service for small and medium size enterprise."

Chapter 5

8. Barenji, Ali Vatankhah, Reza Vatankhah Barenji, and Majid Hashemipour "Improving Multi-Agent Manufacturing Control System by Indirect Communication Based on Ant Agent" submitted to *Journal of Intelligent Manufacturing*.

9. Vatankhah Bareni Ali. "Cloud Based Manufacturing Execution System: CaseStudy FMS". *International Journal of Industrial and Systems Engineering* 1 (2017):1-10

Chapter 2

LITERATURE REVIEW

2.1 Introduction

Manufacturing systems involve activities related to the production of goods using manufacturing resources and knowledge, according to the external demands and subject to the environmental context, e.g. social and economic aspects. Nowadays, markets demand products with high quality at lower costs, highly customized and with short life cycle. Therefore can be considered that mass production is shifting to mass customization [13].

In this scenario, the increase of competitiveness expressed in more productivity, more quality, more agility, more flexibility and better adaptation to unexpected disturbances is crucial for an enterprise staying in the business. Aiming to increase the competitiveness, some manufacturing enterprises tended to divide themselves into small sub-enterprises, belonging or not to the mother enterprise, each one having a specific business core, and being specialized in the production of a small range of products. The enterprise geographic expansion, through the geographical distribution of factory plants, administrative and sales offices, led to the concept of distributed production systems, which has impact at all levels of the enterprise, from the inter-enterprise level to the shop floor level[14].

More recently, the competitiveness is reached by cooperation between the enterprises. This situation provides the opportunity. Another way to achieve increased competitiveness is to use innovative technologies, through the introduction of industrial automation systems joint with information technologies. The choice, design and integration of adequate technologies in the system are essential since the introduction of emergent technologies by itself does not solve the problems[15]. This trend is due to the great development of technologies that involve microprocessors, robots, numerical control machines, communication networks, artificial intelligence, etc.

The information technology (IT) system plays a critical role in increasing the performance parameters of manufacturing system. In general, IT is an important asset in the management of industrial enterprises and helps manage that asset[16]. IT enables firms to integrate the decision functions that exist in the myriad of subsystems required to manufacture and distribute a product. These subsystems include sales, purchasing, production scheduling, quality control, process control, and supply chain logistics[14]. The main parts of IT in manufacturing system are control system and scheduling. Traditionally these systems were implemented using centralized approaches due to high statistic optimization capability but in the actual manufacturing environment is dynamic therefore must be consider flexibility and agility in the control and scheduling system[17]. The IT structure of manufacturing factory is illustrated in Fig 2. With respect to this structure IT is categorized in the three layers namely; enterprise resource planning (ERP), manufacturing execution system (MES) and machine control layer. This layers can defined as follow[18].

ERP is business process management software that allows an organization to use a system of integrated applications to manage the business and automate many back office functions related to technology, services and human resources.

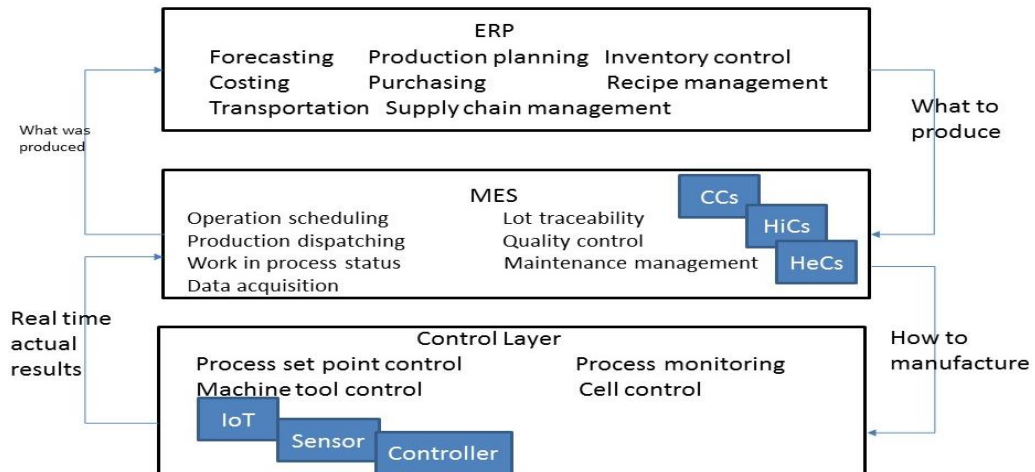

Figure 2: IT structure of manufacturing factory

ERP in the manufacturing has added support for some of the following functions such as Quality Management, Sales and Distribution, Human Resource Management, Project Management, Logistics Supply Chain Management, Intercompany Communications and Electronic Commerce.

Manufacturing execution system (MES); The MES is an attempt to manage resources, including materials, machines, and personnel, on a daily or even hourly basis. Typical MES functions including such as, dispatching and monitoring production, detailed scheduling associated with specific production, data collection from factory floor operation to provide a history of factory events, quality data analysis and product history recording.

The machine control level is responsible for ensuring that the sequence of machine operations corresponds to the planned sequence necessary to fabricate the part. Typically, the sequence of operations is carried out as prescribed by the program resident in the machine controller, and there are few, if any, decisions to be made.

In the traditional structure, each layer has offline-based communication and used central control system, the centralized approaches introduces good response to production optimization but not agile and reconfigurable system. This thesis focus on the MES and machine layers and it is not consider the high level of business management system such as ERP. In the shop floor level of manufacturing system (MES & Machine control) current challenges are the development of system more response to dynamic reconfiguration and flexibility.

The purposed of this chapter is to analyses and contextualize the manufacturing system, reviewing their state of the art and highlighting the weakness and disadvantages of current system especially control and scheduling system. Firstly, the manufacturing system is explained and their classification and the historical evolution of the manufacturing paradigms are reviewed. Then new types of manufacturing system and approach is presented, by defining the several types of flexibility found in manufacturing domain and describing the current automation technologies and computer integrated manufacturing and distributing manufacturing concepts.

2.2 Manufacturing system

Manufacturing system can be defined, as a system is a collection of integration physical system (resource), humans (people), and operation via IT, that aiming to perform one or more processing and/or assembly operation on a starting raw material

part or set of parts[19]. The first essential components of manufacturing system depicted in Fig 3.

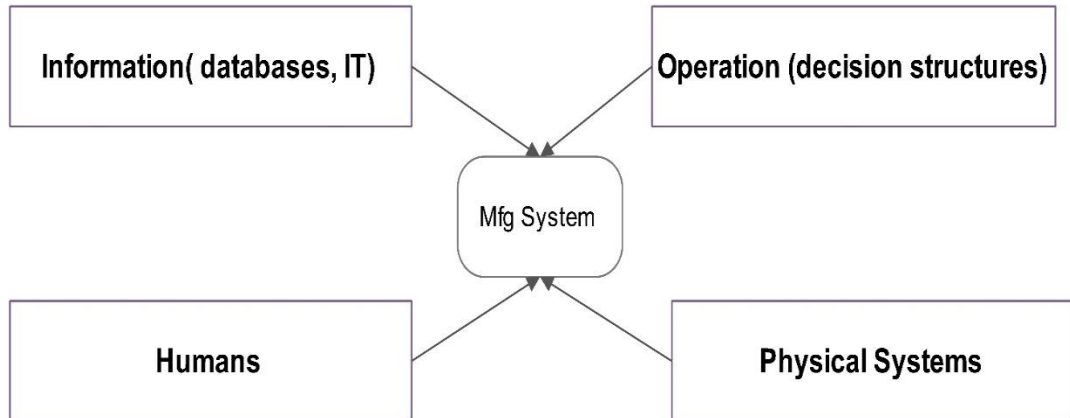

Figure 3: Components of Manufacturing System

The process of designing a manufacturing system must engage upon the design of each of the above four components and their integration. Socnlenius [20] is proposed manufacturing system component based on Fig 4. The impact of each component in this architecture is clear so that IT has more impact in this architecture because has a mediate role in the system between all component. Definition of each parts is give in below.

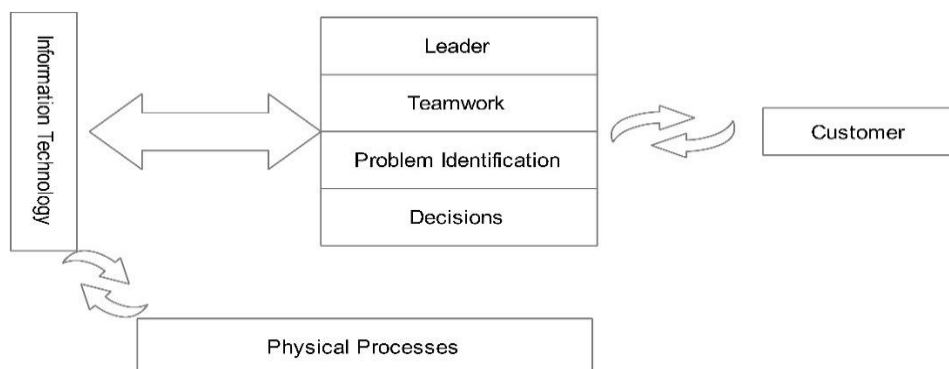

Figure 4: impact of IT components

Physical Systems is refer to all physical aspects of a manufacturing system, operation is refer to all aspects of decision structures that control how the system roles. Information is refers to all data that will be accessed by some function /person/decision-maker/software etc., and whose value may be used deciding upon an action. Humans is refers to all workers, sellers etc.

2.2.1 Classification of Manufacturing Systems

The aim of manufacturing system producing production so the manufacturing system can be classified according to the products produced. Based on products produced manufacturing system categorized on two type namely discrete system and continuous system[13]. A discrete system is a system with a countable number of states. Such as machine industry and example for continuous system is Oil Company or Petroleum Company. This thesis focus on the discrete system and aiming to improve of this system.

Generally, discrete manufacturing system can be categorized according to “production type”, “production layout” and “production volume” [13]. Fig 5 illustrated this classification of manufacturing system.

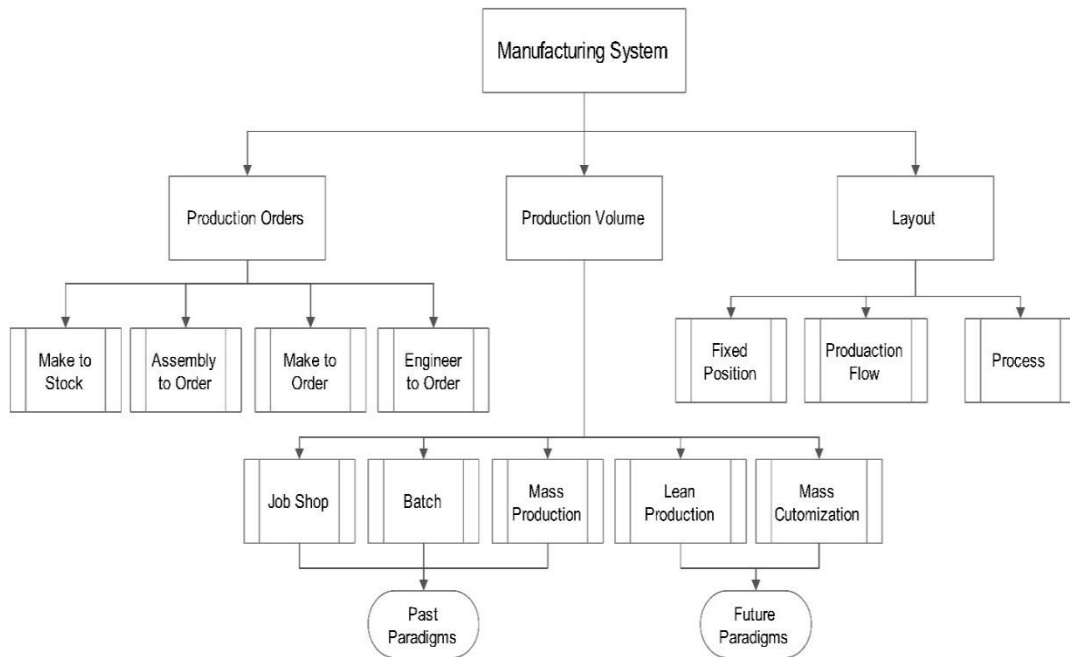

Figure 5: Classification of manufacturing system

2.2.1.1 Production order

Based on the production orders manufacturing system divided into four types namely; make to Stock, Assembly to Order, Make to Order and Engineer to Order. Make to stock (MTS) is a strategy that is manufacture to the forecasted demands of consumers. The MTS is a policy for predicting the demands, in other to anticipating how much production store should be made available. The assembly to order (ATO) is plan of production where the ordered harvests by the consumers are quickly produced, and additionally customized to a certain extent. The ATO needs product's fundamental part are manufactured or fabricated already but need not to be assembled yet. The Make to order (MTO) is a unique strategy of production whereby it affords the opportunity to consumers to be able to purchase products that can be tailored to their specifications. The MTO is to manufacture product only when the customer in question orders for it. The last one is Engineer to order (ETO), this is a process of manufacturing that is fueled by the driven demand practices in which the components are being designed. as well as engineered and then built to a certain specification only when the order in

question has been fully received or when it is a "make to order" type extension in which a certain type of product is manufactured and designed with respect to the specifications of the customers.

2.2.1.2 Production volume

Job shop is typically small manufacturing systems that handle job production. Job shops usually move on to diverse jobs (possibly with different customers) when each job is completed. In job shops machines are aggregated in shops by the nature of skills and technological processes involved, each shop therefore may contain different machines, which gives this production system processing flexibility, since jobs are not necessarily constrained to a single machine. The problem of job shop scheduling is considered strongly NP-hard[21]. Merits of job shop such as 1. Product engineering high flexibility, 2. High expansion flexibility, 3. High production volume elasticity, 4. Low obsolescence (typically machines can have more than one function), 4. High robustness to machine failure. In addition, demerits of job shop such as extremely difficult scheduling due to high product variability and twisted production flow and low capacity utilization.

Batch production involves manufacturing and production of so many little sized quantities of similar products. Batch production has a general purpose, which is specifically tailored for increased rates of production. Batch production is most common in bakeries and in the manufacture of sports shoes. Merits of batch production include: 1. Fewer machines are necessary, 2. Specialized supervision is possible, 3. Not so capital intensive, 4. Low investment in machines, 5. Job satisfaction for operatives. In addition, demerits of batch production is 1. The handling of material is completely costlier because it flow takes longer time and it is irregular, 2. PPC is

elaborate, 3. Production time is longer generally, 4. WIP ties up large capital and space, 5. Higher order skills are incredibly necessary with respect to the variety.

Mass production is the name given to the method of producing goods in large quantities at low cost per unit. One thing to take into consideration is the equipment and the plant of the factory that is utilized for the production in mass scale is completely channeled or focused on a particular product production. The assembly lines concept is utilized for the production in mass scale. During the assembly line, there is a continuous movement of material at a speed that is uniform. When it is on the line, it arrives at several workstation where part of the portion of work is executed[22]. The advantages of this system such as; 1. There is a smooth flow of material, Small WIP, 3. Production time as a whole is short, 4. Closely spaced WS's reduce material handling, 5. Don't need to be an expert, 6. Less training cost, 7. Less storage space is required. The disadvantages of this system such; as 1. The whole line of the assembly is compromised if there is a failure of just a single machine. 2. Maintenance is challenging. 3. Assembly lines are not flexible. 4. Great changes in layout are necessary when product line changed. 5. Production speed is determined by slowest machine. 6. Specific supervision is not required but rather this system employs a general supervision. 7. It requires general rather than specific supervision. 8. The duplication of machine gives rise to more capital requirements.

The paragraph examine how to past paradigms is shift to new paradigms in the production volume. In each paradigm, we discuss the contributions of scientific principles, advantages and disadvantages. The Craft Production is first paradigm, which created the product the customer requested but at a high cost[23]. There were no manufacturing systems associated with paradigm. Craft production can be defined

such as the process of manufacturing by hand with or without the aid of tools [24]. Industrial example for this paradigm can be consider Henry Ford decision in the beginning of 20th century, it decided to build a car that everybody cloud own and drive[25]. Form 1970 up to know four types of manufacturing paradigm emerged. This manifestation in the manufacturing paradigm simultaneously merged by growing IT. Considering the advent of each of the paradigm; Mass Production, Lean Production, Agile Production and Mass Customization. The evolution of the manufacturing paradigms is illustrated in Fig 6 using a volume-variety relationship. In the remainder of the paragraph, we review these paradigms in the detail.

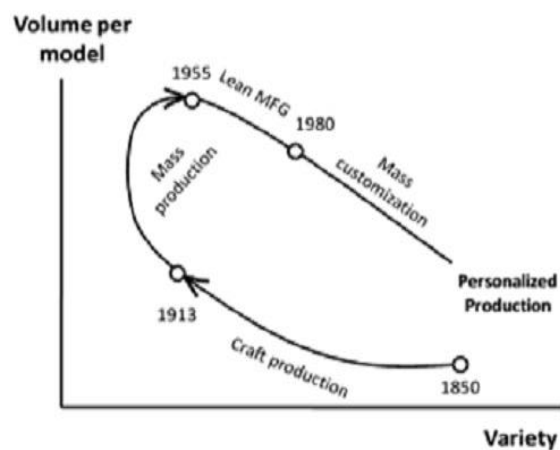

Figure 6: production paradigm[23]

Lean production

Lean is a continuous improvement philosophy, which is Synonymous with Kaizen or the Toyota Production System[26]. The history of lean management or lean manufacturing is traced back to the early years of Toyota and the development of the Toyota Production System after Japan's defeat in WWII when the company was looking for a means to compete with the US car industry through developing and implementing a range of low-cost improvements within their business.

Lean manufacturing focused on eliminating waste and empowering workers, reduced inventory and improved productivity[27]. Instead of maintaining resources in anticipation of what might be required for future manufacturing. Therefore briefly, lean management seeks to implement business processes that achieve high quality, safety and worker morale, whilst reducing cost and shortening lead times[28].

Mass customization

Presently, the customer demand for specific and customized products leads to the concept of mass customization, which concentrates on satisfying the separate customer needs. While in lean production the focus is on the elimination of the waste in the process, in mass customization the focus is on the elimination of the waste in products by eliminating the features unwanted by customers. So mass customization is defined as a process of delivering wide market goods and services that are modified to satisfy a specific customer need. A marketing and manufacturing technique combines the flexibility and personalization of custom mode products with the low unit costs associated with mass production[29]. Mass customization requires the increase in flexibility, agility and reconfiguration using new technology such as CNC machine, automation technologies, robots, AGV and CAD/CAM/CIM systems. In this respect many manufacturing systems are proposed such as flexible manufacturing system (FMS), flexible assembly line (FAL), flexible flow line (FFL). For comparison between all types, manufacturing paradigm Table 2 depicted in detail[13, 14].

Table 2: Comparison of new paradigms in manufacturing system

	Mass Production	Lean Production	Agile Production	Mass customization
Product Variety	Few often only one	Finite number of variants of a single	Customized products	High variety and customization
Product volume	High	small	All levels	All levels
Equipment	Fixed automation	Programmable and flexible	Highly flexible and integrated automation	Highly flexible and integrated automation
Emphasis	Standard product	Quality and flexibility	High responsiveness to disturbances	Low cost production, high quality

The conclusion is that in the 21st century, companies are going to operate in a dynamic and challenging environment that requires new approaches to manufacturing. Mass customization is a general trend that is more and more widespread, seeming to be as the production paradigm for the factory of the future. From the manufacturing point of view, much work must be done to develop adequate manufacturing systems meeting the new requirements, since traditional solutions do not seem to be able to face the demands of mass customization. The important indicated on new manufacturing system consist of flexibility, re-configurability and agility. One of the main approach that could be cover the mass customization is agile manufacturing therefore in the 20st century manufacturing system try to shift to agile manufacturing, in the next paragraph.

Agile manufacturing

The agile manufacturing is a manufacturing paradigm, introduced by the Iococca Institute at Lehigh University, is the ability to adapt quickly and profitably to continuous and unexpected changes in the manufacturing environment[30]. It presents continuous improvement, rapid response, quality improvement, common responsibility and whole client focus.

Agile manufacturing is a vision of manufacturing that is a natural development from the original concept of lean manufacturing. In lean manufacturing, the emphasis is on cost cutting. The requirement for organizations and facilities to become more flexible and responsive to customers led to the concept of agile manufacturing as a differentiation from the lean organization. This requirement for manufacturing to be able to respond to unique demands moves the balance back to situation prior to introduction of lean production, where manufacturing had to respond to whatever pressure were imposed on it, with the risks to cost and quality. The move to lean production from agile and vice versa is a major challenging task[31].

In the simple terms agile manufacturing can be considered as the integration of organization, highly skilled and knowledgeable people and advanced technologies, to achieve cooperation and innovation in response to the need to supply the customers with high quality customized products. This concept is illustrated in Fig 7.

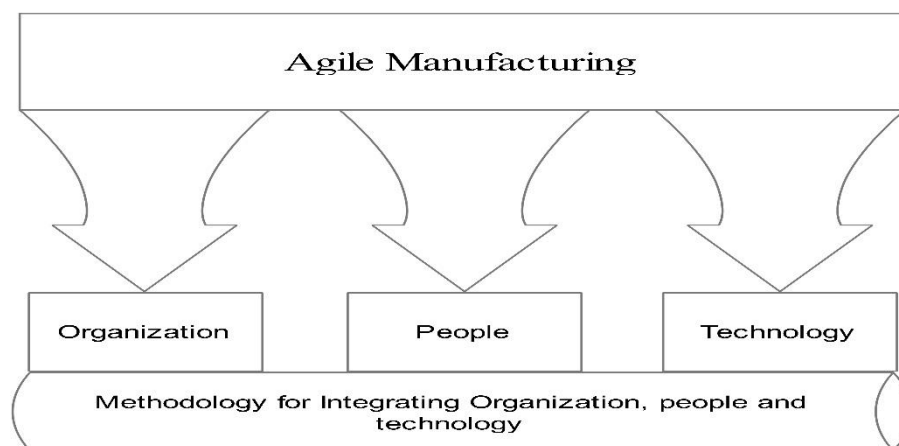

Figure 7: The structure of agile manufacturing[32]

Agile manufacturing has different requirements of workforce as compared to that of traditional systems and they are: (a) closer interdependence among activities. (b) Different skill requirements, usually higher average skill levels. (c) More immediate

and costly consequences of any malfunction. (d) Output more sensitive to variations in human skill, knowledge and attitudes and to mental effort rather than physical effort. (e) Continual change and development. (f) Higher capital investment per employee, and favor employees responsible for a particular product, part or process. These to same extent define the characteristics of agile workforce and the training and education required and some of them are; IT skilled workers, knowledge in team working, negotiation, advanced manufacturing strategies, and technologies, empowered employees, multifunctional workforce, multi lingual workforce and self-directed teams.

2.2.2 Technologies in Manufacturing Systems

In a global manufacturing environment, information technology plays a dominant role of integrating physically distributed manufacturing firms. Critical to successfully accomplishing AM are a few enabling technologies that include robotics, Automated Guided Vehicle System (AGVs), Numerically Controlled (NC), machine tools, Computer Aided Design (CAD), Computer Aided Manufacturing (CAM), rapid prototyping technology, IoT, Cyber Physic system (CPs)[3, 10, 33]. Some of the key agile enabled technologies include mobile robots, intelligent parts, and flexible fixtures and smart data sharing, tactical and operational performance measures are to be considered in assessing the impact of alternatives with the objective to select the most suitable technologies[34]. Visual inspection is one such task and there is need for elective automated visual inspection systems in agile manufacturing environments[33].

Towards achieving agility in manufacturing, MG et al[35] has discussed the re-configurability of a manufacturing system. It is analyzed based on the relationship of component routes, material handling costs, reconfiguration cost, and so on. Components with similar routes are selected in an early design stage in order to

minimize the number of machines to be relocated. The variety of resources required in reduced by a proper selection of components and manufacturing processes for system reconfiguration. The systems for AM should include mostly software/ decision support systems for various planning and control operations including materials requirements planning, MRP, scheduling and production planning and control. Based on the nature of agile manufacturing environments several computer integration systems have been developed that could be used for agile manufacturing, some of them are as follows; MRPII, CAD/CAE, ERP, IoT, SCADA.

2.2.3 Flexibility and Agility in Manufacturing Systems

Flexibility is one of the key objectives of any manufacturing system and a critical measure of total manufacturing performance [36, 37]. It ensures that manufacturing can be both cost efficient and customized at the same time. As setup time decreases, small batch production can be as economical as large-scale manufacturing. This enables the organization to change its competitive strategy from economies of scale to economies of scope [38]. More importantly, flexibility embodies competitive value for a manufacturer. A basic problem in manufacturing may be described as demand uncertainty. Under such conditions, the ability of a manufacturing system to respond appropriately to this uncertainty will determine the stability and profitability of the business unit. "The competitive value of manufacturing flexibility lies in its ability to neutralize the effects of demand uncertainty" [39].

Flexibility studies have focused on production environments and inter organizational elements such as mix, volume, product and production routes. Sharif and Zhang[40] determined that flexibility was not sufficient to address new market challenges market by intense competitive environment. Browne et al.,1984[41] defines flexibility in manufacturing system as an integrated computer-controlled system with automated

material handling devices and CNC machine tools and which can be used to simultaneously process a medium-sized volume of a variety of parts and offered a simulation study using Taguchi's method analysis of physical and operating parameters of the flexible manufacturing system along with flexibility. The physical and operating parameters of alternative resources may influence the system's performance with the changing levels of flexibility and operational control parameters such as scheduling rules.

The classification of flexibility types established by Browne et al. [42] who has formed the foundation of most consequent research into measuring manufacturing flexibility. It has been recognized in literature that there are three levels of manufacturing flexibility[37].

2.2.3.1 Basic flexibilities

- **Machine flexibility:** It refers to the various types of operations that the machine can perform without requiring prohibitive effort in switching from one operation to another [42].
- **Material handling flexibility:** A measure of the ease with which different part types can be transported and properly positioned at the various machine tools in a system.
- **Operation flexibility:** A measure of the ease with which alternative operation sequences can be used for processing a part type. It is the ability to interchange the sequence of manufacturing operations for a given part.

2.2.3.2 System Flexibilities

- Volume flexibility: A measure of a system's capability to be operated profitably at different volumes of the existing part types. It is the ability to operate profitably at different production volume.
- Expansion flexibility: The ability to build a system and expand it incrementally. It is the ability to expand the capacity of the system as needed, easily and modularly.
- Routing flexibility: A measure of the alternative paths that a part can effectively follow through a system for a given process plan. It is the ability to vary the path a part may take through the manufacturing system.
- Process flexibility: A measure of the volume of the set of part types that a system can produce without incurring any setup. It is the ability to change between the productions of different products with minimal delay.
- Product flexibility: The volume of the set of part types that can be manufactured in a system with minor setup. It is the ability to change the mix of products in current production, also known as mix-change flexibility (Carter, 1986).

2.2.3.3 Aggregate flexibilities

- Program flexibility: The ability of a system to run for reasonably long periods without external intervention.
- Production flexibility: The volume of the set of part types that a system can produce without major investment in capital equipment.
- Market flexibility: The ability of a system to efficiently adapt to changing market conditions.

2.2.4 Agility in Manufacturing System

Manufacturing agility is evolved as an essential capability for organizations to handle uncertainties in rapidly changing business environment. However, manufacturing agility is highly valuable for companies but little empirical researches have done to elucidate its construct. The manufacturing agility metric is problematic to develop due to its multidimensional and uncertain nature. Agility is vital concept if the manufactures have to stay competitive within a highly unstable marketplace. Abundant of literatures have suggested the notion of manufacturing agility capabilities to quickly respond to the market instabilities[40]. Many theorists describe agile manufacturing as the capability of surviving and prospering in a competitive environment of continuous and unpredictable change by reacting quickly and effectively to changing markets, driven by customer designed high quality, high-performance, products and services.

Agility is the measure of a manufacturer's ability to react fast to sudden, unpredictable change in customer demand for its products and services and make a profit [43]. Industries are embracing the concepts of agile manufacturing, which favor nimble

principles over the aging techniques of mass production. In expert's view, AM is explained as the ability to produce so-called custom-engineered or custom-specific parts usually in short production runs or one-of-a-kind batches. Other theorists define agility as the ability to accomplish rapid changeover between the manufacture of different assemblies utilizing essentially the same work cell and allow the rapid introduction of new products with little or no work cell downtime. It has been documented in theoretical studies that agile manufacturing is a response to complexity brought about by constant change. Agility is an overall strategy focused on thriving in an unpredictable environment. Focusing on the individual customer, agile competition has evolved from the unilateral producer-centered customer-responsive companies inspired by the lean manufacturing refinement of mass production to interactive producer-customer relationships[44]. Due to inherent complexities and agile associated with modern manufacturing system, modelling these interactive subsystem-using common analytical and mathematical approach has proved to be very difficult. Agile manufacturing system is a multi-objective seeking system. An uppermost level, Agile manufacturing system takes the customer needs, feedback, and part of society's total energy information then transform them in such a way as to produce the output more efficiently[45].

2.3 Flexible Manufacturing Systems

In the 21st century, companies are expected to operate in a dynamic and challenging environment that requires new approaches to manufacturing. Due to the requirements of flexibility that are explained on the top paragraph, FMS has evolved in the last 80s. Firstly, FMS is a manufacturing technology. Secondly, FMS is a philosophy. “System” is the key word. Philosophically, FMS incorporates a system view of manufacturing. FMS is simply one way that manufacturers are able to achieve this agility. FMS is defined as follow [46]; “FMS consists of a group of processing work stations interconnected by means of an automated material handling and storage system and controlled by integrated computer control system.”

FMS is called flexible due to the reason that it is capable of processing a variety of different part styles simultaneously at the workstation and quantities of production can be adjusted in response to changing demand patterns. The FMS has a three basic components and each of them consist of sub component. Firstly workstation that consist of three sub component namely; 1) machine centers 2) load and unload stations 3) assembly work stations. Second basic component is automated material handling and storage system is used to transport work parts and subassembly parts between the processing stations.

The last basic component is computer control system is used to coordinate the activities of the processing stations and the material handling system in the FMS. It is play crucial role in the flexibility and agility of the system [10]. Fig 8 shows the FMS by considering the three basic component and their communication.



Figure 8: FMS by considering the three basic component [46]

The FMS often provide the advantages such as; Productivity increment due to automation, Preparation time for new products is shorter due to flexibility, Saved labor cost due to automation, improved production quality due to automation.

2.4 Computer Integrated Manufacturing

Computer-integrated manufacturing (CIM) refers to the use of computer-controlled machineries and automation systems in manufacturing products. CIM combines various technologies like computer-aided design (CAD) and computer-aided manufacturing (CAM) to provide an error-free manufacturing process that reduces manual labor and automates repetitive tasks. The CIM approach increases the speed of the manufacturing process and uses real-time sensors and closed-loop control processes to automate the manufacturing process. It is widely used in the automotive, aviation, space and shipbuilding industries.

The major components of CIM are as follows:

- Data storage, retrieval, manipulation and presentation mechanisms
- Real-time sensors for sensing the current state and for modifying processes
- Data processing algorithms

2.5 Industry 4.0

Industry 4.0 or the fourth industrial revolution [47] is the current trend of automation and data exchange in manufacturing technologies. It includes cyber-physical systems, the Internet of things and cloud computing. The concept of industry 4.0 is widely used across Europe sector. In the United State and the English- speaking world more, generally some commentators also use the terms the ‘internet of things’, the ‘internet of everything’ or the ‘industrial internet’. What all these and concepts have in common is the recognition that traditional manufacturing and production methods are in the throes of a digital transformation. For some time now, industrial processes have increasingly embraced modern information technology but the most recent trends for beyond simply the automation of production that has, the Fig 9 illustrated the all methods from 18th century until today.

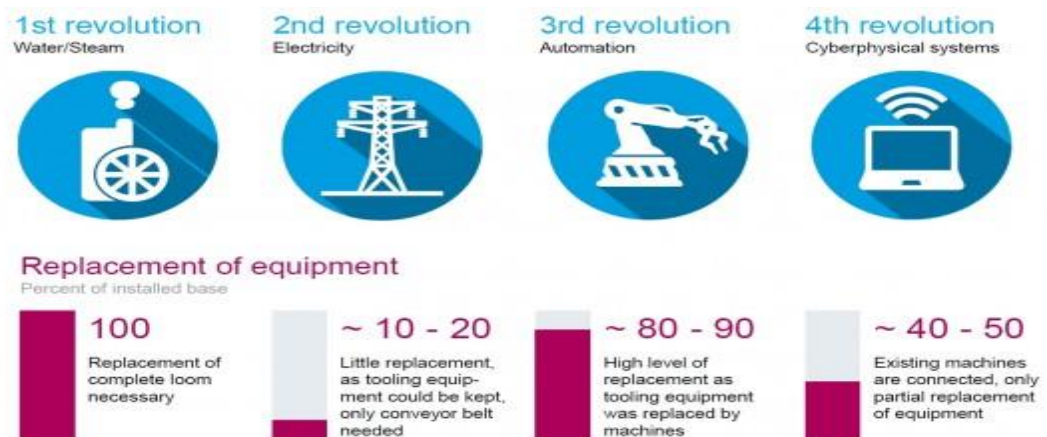

Figure 9: all types of revolution in industries

One of the important component of industrial 4.0 is radio identification technology (RFID). RFID is a technology that incorporates the use of electromagnetic or electrostatic coupling in the radio frequency (RF) portion of the electromagnetic spectrum to uniquely identify an object, animal and person. RFID is coming into

increasing use in industry as an alternative to the bar code. The advantage of RFID is that it does not require direct contact or line-of-sight scanning. An RFID system consists of three components: an antenna and transceiver (often combined into one reader) and a transponder (the tag). The antenna uses radio frequency waves to transmit a signal that activates the transponder. When activated, the tag transmits data back to the antenna. The data is used to notify a programmable logic controller that an action should occur. The action could be as simple as raising an access gate or as complicated as interfacing with a database to carry out a monetary transaction. Low frequency RFID systems (30 KHz to 500 KHz) have short transmission ranges (generally less than six feet). High-frequency RFID systems (850 MHz to 950 MHz and 2.4 GHz to 2.5 GHz) offer longer transmission ranges (more than 90 feet). In general, the higher the frequency, the more expensive the system.

2.6 Manufacturing Control and scheduling Paradigms

The present chapter will draw the current state of the art regarding the production and manufacturing control paradigms that are directly affected to agility and flexibility of manufacturing system. One of the aim of this thesis is developed new agile and flexible manufacturing control and scheduling system. The most traditional and more recent paradigms characteristics and approaches will be analyzed, as well a deeper explanation of the multi agent based manufacturing control architecture, followed by the discussion of the remaining problems and challenges in this area.

2.6.1 Production scheduling and Manufacturing Control

Each industrial facility is built upon a complex system of systems, where raw materials, or semi-finished products, are processed and combined using a set of internal resources, and are delivered as finished goods. In the simple word, scheduling can be defined as a process of arranging, controlling and optimizing work and

workloads in a production process or manufacturing process. Scheduling is used to allocate plant and machinery resources, plan human resources, plan production processes and purchase materials. Scheduling is an important tool for manufacturing and engineering, where it can have a major impact on the productivity of a process[48]. In manufacturing, the purpose of scheduling is to minimize the production time and costs, by telling a production facility when to make, with which staff, and on which equipment[49] . Production scheduling aims to maximize the efficiency of the operation and reduce costs [7].

Likewise in the simple word production control can be defined is the activity of monitoring and controlling any particular production or operation. It is a "set of actions and decision taken during production to regulate output and obtain reasonable assurance that the specification will be met"[19].

Nowadays manufacturing system is divided to four layers as mention before. These four layers comprise the control (layer1 and 2), operation layer 3 and layer 4 is business. the objective of level 1 and 2 is the control of equipment which leads to the execution of the production process aiming the production of the products, comprising e.g., PLC (Programmable Logical Controller)s, resources, CNC (Computer Numerical Control) and SCADA (Supervisory Control And Data Acquisition). Level 3, also named the MES (Manufacturing Execution System) layer activities, comprises several preparation activities, such as detailed scheduling, quality management and maintenance that are undertaken to prepare, monitor and complete the production process that is executed at the lower levels. Level 4 is the highest level, also named the ERP (Enterprise Resource Planning) layer, being related to the layer where strategic decisions are taken, such as financial and logistics. The subject of this thesis

is to propose a manufacturing control and scheduling architecture that covers at least partially, the levels 2 and 3.

2.6.1.1 Manufacturing scheduling

Manufacturing scheduling is the process of selecting and sequencing manufacturing processes such that they achieve one or more goals and satisfy a set of domain constraints. Manufacturing scheduling is the process of selecting among alternative plans and assigning manufacturing resources and time to the set of manufacturing processes in the plan. It is, in fact, an optimization process by which limited manufacturing resources are allocated over time among parallel and sequential activities. With the manufacturing globalization, such an optimization process is becoming more and more important for manufacturing enterprises to increase their productivity and profitability through greater shop floor agility, and survive in a globally competitive market[50].

Most scheduling problems are considered NP hard, i.e., it is impossible to find an optimal solution without the use of an essentially enumerative algorithm and the computation time increases exponentially with problem size. Manufacturing scheduling is one of most difficult problems in all kinds of scheduling problems. It becomes more complex when considering multiple manufacturing resources, integration of process planning and scheduling, and dynamic situations in shop floors[51]. Within the past two decades, researchers have applied agent technology in attempts to resolve the manufacturing process planning and scheduling problems[52]. In fact, this represents one of the most active research topics on agent-based manufacturing.

2.6.1.2 Manufacturing shop floor control

Manufacturing shop floor control relates to strategies and algorithms for operating a manufacturing plant, taking into account both the present and past-observed states of the manufacturing plant, as well as the demand from the market. The manufacturing control problem can be considered at two levels: low and high level. At the low-level, the individual manufacturing resources are to be controlled to deliver unit-processes expected by the high-level control functions. High-level manufacturing control is concerned with coordinating the available manufacturing resources to make the desired numbers of types of products. DSM is usually applied to high-level manufacturing control, but can also be applied to the lower level[53].

Trentesux [54]classified manufacturing control system in the four typological classes. Normally manufacturing control architectures rely on a pure centralized control system, where one central decisional entity governs the full spectrum of the operation system. The Class I divides the massive processing needs found in Class 0 by placing one decision entity into each of the (sub) systems to control and by clustering those into higher level recurring to the sub-division, but following a fully hierarchical approach. Class II clusters the control architectures that proposes a hybrid manufacturing control merging the optimization of hierarchical system with the flexibility of heterarchical ones. Lastly, Class III control systems propose a fully decentralized control, distributing the processing capabilities among a set of individual and autonomous entities. Figure 10 illustrated this classification.

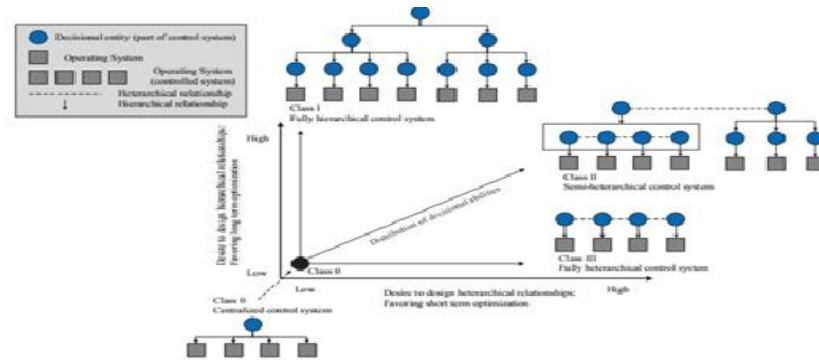

Figure 10: classification of manufacturing control system[54]

The consequences for production imply the need for agile and flexible control systems with enhanced adaptability to significant degrees of uncertainty and disturbances such as machine failures or customer demand change and uncertain processing time[55]. As well as to the frequent changes to shop floor layout. The distributed manufacturing control and scheduling is major development in the field of intelligent manufacturing since it allows the main requirements of manufacturing flexibility such as; robustness, re-configurability and scalability.

The traditional manufacturing or centralized based scheduling and control architectures were among the first to be developed in the manufacturing system field. The most successful of those was the CIM based architecture, which promoted the computerization of all the production life-cycle from the early stages of the design phase until the final product production.

The system such as FMS and CIM employ automated scheduling and control systems executed by cell control computers. Such scheduling and control systems are intended to coordinate and integrate different resources for optimizing the operation of the manufacturing system. Scheduling could be made by off line schemes or real time schemes. The latter can make more effective and quick decision and handle system

interruption more easily than the former. The issue of real time scheduling has attracted the attention of many researchers in recent years. Various approaches have been developed to realize the real time scheduling function such as the numerical approach, the learning based approach (neural network), the expert system based approach, the knowledge based approach and Petri net based approach[56]. However, the effectiveness of these new approaches is limited owing to the requirement for centralized control structures. In other words, cell control computers centrally assign the part programs, schedules and production routing in CIM and FMS. Each machine performs the pre assigned tasks according to assignment made by the cell controller. Such an approach lacks the flexibility to handle interruptions or resource breakdowns so these systems work well only when no major machine breakdown or customer demand occur during the system operation. The system performance drops dramatically and abruptly when interruption conditions become severe[57]. In the centralized control, machines in an FMS also lack the ability to cooperate and negotiate among themselves.

The traditional manufacturing control systems with centralized control architectures do not support efficiently the current requirements imposed to the agile manufacturing systems[10]. With the increase of powerful inexpensive and widely available computational resources, the architecture evolved from centralized to distributed and dynamic approach, requiring the need for some degree of autonomy to enable components to respond dynamically to changes.

Recently, manufacturing control and scheduling architectures are assuming the decentralization of the processing capabilities and following a distribution of the decisional nodes bringing them closer to where they are needed[58]. This new trend

will probably gain an extra momentum by the promotion of the multi agent system and Industrial Internet[59] initiatives, being the first one seen as the 4th industrial revolution. For this purpose, a design trend has emerged over the past years, being the most promising the ones developed under the multi agent based system paradigm.

2.7 Multi agent system

The concept of “agent” root from the dictionary of distributed artificial intelligence (DAI) popular in the 1970s. Research on agents and multi agent systems (MASs) has since succeeded, embarking on a myriad of paths and touching on numerous applications, to which the plethora of possible definitions and classifications for agents and MASs attest. Maes [60] provided the following definition of an agent: “a computational system which is long lived has goals, sensors and effectors, decides autonomously which actions to take in the current situation to maximize progress toward its (time varying) goals.” The same author went further to define a software agent as a “particular type of agent, inhabiting computers and networks, assisting users with computer based-tasks.” On the Internet, for example, agents are programs that can gather information or perform some other services without an immediate user presence.

Figure 11 shows a possible representation of a generic software agent, highlighting its nature as a self-contained component able to live and communicate in an environment, i.e., an information world, by means of sensors and actuators specific for information management. A single software agent perceives or communicates with other software entities (like services and databases), which do not act to pursue a specific objective, but only to satisfy requests. An agent is also able to communicate with the physical world, receiving data from devices (e.g., measures or alarms) and sending control

signals or sending and receiving messages from users. A software agent can also work in computer networks by receiving and sending data, messages, and signals to possible remote destinations.

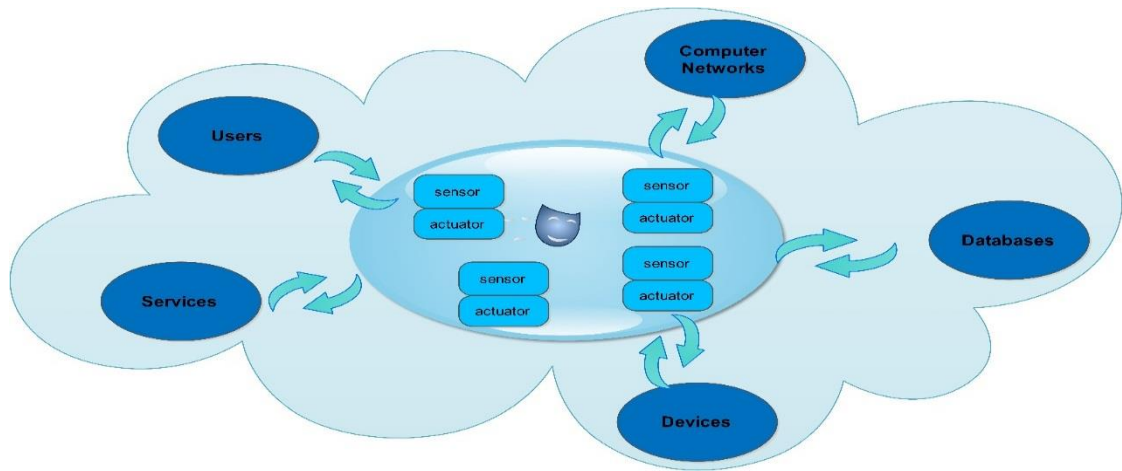

Figure 11: generic software agent inspired by[2]

Wooldridge and Jennings [12] identified three different classes of agents:

- Agents that execute straightforward tasks based on pre-specified rules and assumptions.
- Agents that execute a well-defined task at a user's request.
- Agents that volunteer information or services to a user whenever it is deemed appropriate, without being explicitly asked to do so.

Nwana [61] illustrated that main characteristics an agent should exhibit have been identified in a set of three attributes: autonomy, cooperation, and learning. Although

truly smart agents possessing all three characteristics do not yet exist, a more complex range of agent typologies has been defined on the grounds of the previously mentioned characters as well as other characteristics:

- Collaborative agents emphasize autonomy and cooperation to perform tasks by communicating and possibly negotiating with other agents to reach mutual agreements; these are used to solve distributed problems in which a large centralized solution is impractical.
- Interface agents are autonomous and utilize learning to perform tasks for their users; the inspiration for this class of agents is a personal assistant that collaborates with the user.
- Mobile agents are computational processes capable of moving throughout a network, interacting with foreign hosts, gathering information on behalf of the user, and returning to the user after performing their assigned duties.
- Information agents are tools used to help manage the tremendous amount of information available through networks such as the World Wide Web and the Internet.
- Reactive agents represent a special category of agents that do not possess internal, symbolic models of their environments, but instead act or respond according to stimuli arising from the environments in which they are embedded.
- Hybrid agents are particular in that they combine two or more agent philosophies within a single agent.
- A heterogeneous agent system refers to a collection of two or more agents with different agent architectures.

Agents operating within MAS may seem less intelligent than individual agents. However, thanks to their ability to integrate according to specific communication and decision protocols [62], they can solve or support the solution of even more complex problems.

Many methodologies for designing multi agent system have been proposed in the past, some even for designing control systems[63]. The methodologies proposed include object-oriented, manufacturing control and agent-oriented methodologies.

2.7.1 Agent communication languages

Agent communication language (ACL) intends to make transparent the data exchange between distributed agents, being crucial to standardize the messages used during the communication act. The two major current agent communication languages are KQML[64] and FIPA-ACL[65], which designate all intentional actions carried out in the course of communication, being the elementary units that make possible to establish a conversation between agent. It is need to explained that all the standard based communication between agents is direct based communication that reduced the self-organization of the system as we mentioned before other aim of this thesis improve the self-organization of proposed system based on indirect communication between agents.

2.7.2 Ontologies

In multi agent systems, the communication between cooperative agents requires a common understanding of the concepts of their knowledge domain. The term ontology is vague and not precise. Gruber [66] defines ontology as a specification of a conceptualization. Guarino [67] extends the previous definition, saying that ontology is a logical theory accounting for the intended meaning of a formal vocabulary. Its ontological commitment to a particular conceptualization of the world. Ontology

represents a common structure so that the agents can use the same semantics of terms in the message for communication and exchange data information. Learning mechanism can be defined as a way to acquire knowledge and skills to respond to the dynamic evolution of the environment and to improve the system ability to act in the future. The idea beyond learning is that perceptions received should be used not only for acting, but also for improving the ability to behave optimally in the future to achieve goals.

Learning is normally adopted when it brings benefits to the manufacturing control context in result of a decision making process or by the observation of the environment, allowing to adjust the decision parameters or even to update the behavior rules.

2.8 Agent based Manufacturing System

Agent technology has been considered as an important approach for developing distributed agile manufacturing systems[68]. A number of researchers have attempted to apply agent technology to manufacturing enterprise integration, supply chain management, manufacturing planning, scheduling and control, material handling and holonic manufacturing system[50]. This part gives a brief survey of some related works in this field.

Shaw[69] may have been the first to propose using agents in manufacturing scheduling and factory control. He proposed that a manufacturing cell can subcontract work to other cells through a bidding mechanism. YAMS [70] was another of the earliest agent-based manufacturing systems, wherein each factory and factory component is represented by an agent. Each agent has a collection of plans, representing its

capabilities. The Contract Net [62] is used for inter-agent negotiation. Most recent projects in this area still use the same idea[71]. In most agent-based approaches proposed for low-level shop floor control, an agent is to represent a physical manufacturing device (cell, machine, robot, AGV, tool etc.). These agents form a heterogeneous or hybrid architecture to negotiate laterally or vertically (through a mediator or coordinator) using coordination protocols by message passing. Most systems apply the Contract Net or its variations. Some others use the Market-like negotiation.

2.8.1 Simulation of Agent-Based Systems

Simulation can be defined as the use of mathematical models to recreate a situation, often repeatedly, so that the likelihood of various outcomes can be accurately estimated. The model is a description of the system, with the detail of the model ranging from a simple representation to a complex behavior of all intervenient involved in the system. The simulation extends the modelling process by adding time to the model and with that, the model behavior can be observed for a better analysis.

The use of simulation environments can provide several advantages [72]:

- Verification and validation without the need to use the real equipment
- The reproduction of different scenarios, irregular conditions or risky tests can be done easily and safely in this virtual world.
- Data can be reused for operator training and maintenance, and the simulations can be repeated as many times as necessary to the correct understanding and tuning of the system control.
- The simulation can be compressed obtaining results that in real environment take long time.

Agent based systems, due to its distributed nature introduce new requirements for modeling and simulation, and the understanding of the system's behavior can be increasingly difficult as the system grows in complexity. Several environments for the simulation of multi-agent systems are reported in the literature, namely in [73]. A well-known example in the manufacturing domain is the MAST (Manufacturing Agent Simulation Tool) simulation environment[74], developed by the Rockwell Automation, focusing the dynamic product routing. MAST was used to simulate two real scenarios[75]: the holonic packing cell at the University of Cambridge, UK and the pallet transfer system at the Automation and Control Institute (ACIN) of the Technical University of Vienna. Another example is found on [76] where a Virtual Reality based approach is used to model and simulate a holonic application to die-casting industry.

Nevertheless, these platforms are developed case-by-case and according to the application particularities, requiring a significant effort to simulate the behavior of agent-based manufacturing control systems. Additionally, the complexity associated to the simulation of distributed systems is increased in presence of complex phenomena, like adaptation, self-organization and chaos, which are common characteristics of complex adaptive systems. Normally, emergent phenomenon has behaviors that differ from classical sciences and the classical methods, like top-down techniques of non-linear systems, is not anymore sufficient. This suggests the use of computational platforms that simplifies these tasks and ensures a framework to simulate/validate strategies during the design phase. When we taking about simulation and MAS, two different dilemma directions are possible. First one simulation of MAS system and second one using MAS systems for simulation of control system. in the this research especially the second aim of this thesis focus on the develop simulation

platform for simulation MAS based control system so this research focus on the first part and not the use of agent based approaches as simulation environments to perform the simulation of control systems.

2.8.2 Agent-Based Modelling and Simulating Environments

ABM is a class of computational models for simulating the simultaneous operations and interactions of multiple autonomous agents aiming to recreate and predict the occurrence of complex phenomena. ABM tools allow the modelling of a system or process by using a MAS system, and posterior simulation in presence of complex phenomena.

These platforms are being used to simulate agent-based models for different application domains, such as economics, chemical, social behavior and logistics. A special remark to the use of ticks (universal time) in simulation environments instead of the real time clock, otherwise it is impossible to compare different simulation results (which are dependent of some parameters such as the processing power of the PC processor).

Several ABM tools are currently available on the market presenting different functionalities, graphical interfaces and programming languages. A summary of some of the most important ABM tools are illustrated in Table 4. All exist simulation platform is general-purpose platform for all types of MAS. However, the MAS based manufacturing systems are different by other types of MAS because hardware level plays a significant role in the system. Therefore regarding to lack of hardware simulation of exist platform the result of these platform is not acceptable by real implementation view.

Table 3: summary of some of the most important ABM tools[73]

	MASON	NetLogo	Swarm	Repast	Anylogic
Available	Free	Free	Free	Free	Trial
Programing effort	Poor	Legend	Good	Poor	Good
Maturity	Poor	Good	Poor	Legend	Poor
User interface	Poor	Legend	Poor	Legend	Legend
Simulation speed	Legend	Good	Good	Legend	Legend

As conclusion, there is no perfect platform to be used, being the choice of the correct ABM dependent of the task to be performed and the skills of the person who will make that task.

2.8.3 Existing agent based manufacturing scheduling and control system

In this paragraph, a review about existing scheduling and control system for manufacturing system based on agent system presented. Within the past decade, agent technology has applied in attempts to resolve the process planning and scheduling problems in the manufacturing. In fact, this represents one of the most active research topics on agent based manufacturing. Table 3 summarized of some well know projects in this field. All project focused on the process planning and scheduling in the manufacturing system. Recent interesting research work in this area includes market-based negotiation protocols, agent-based integration of manufacturing process planning and scheduling, combination of agent-based approaches with traditional scheduling techniques such as heuristic search methods, performance matrix, Perti Nets, Genetic Algorithms, Neural Networks, and Simulated Annealing[2, 6, 31, 49, 50].

One of the resent well known in this field dynamic scheduling and control system based on agent technology is RFID multi agent based distributed manufacturing

system, this project design and developed for improving agility of manufacturing system by considering machine disturbances and it is implemented by in the FMS[33, 77]. Next paragraph explained detail information of this project.

2.9 RFID- Multi Agent Manufacturing System

The RFIDMAMs adaptive multi agent architecture intends to combine the best practices of DMS approach being as smart data gathering from shop floor and as decentralized control system. This agent based control system used structural modeling for designing and real implementation in the FMS for validation and verification system. The methodology is follow object-oriented methodologies and UML tool used for designing of objects and agents, Fig 12 illustrated the proposed methodologies for designing agent based manufacturing system. It is consist of 3 phase and 3 level.

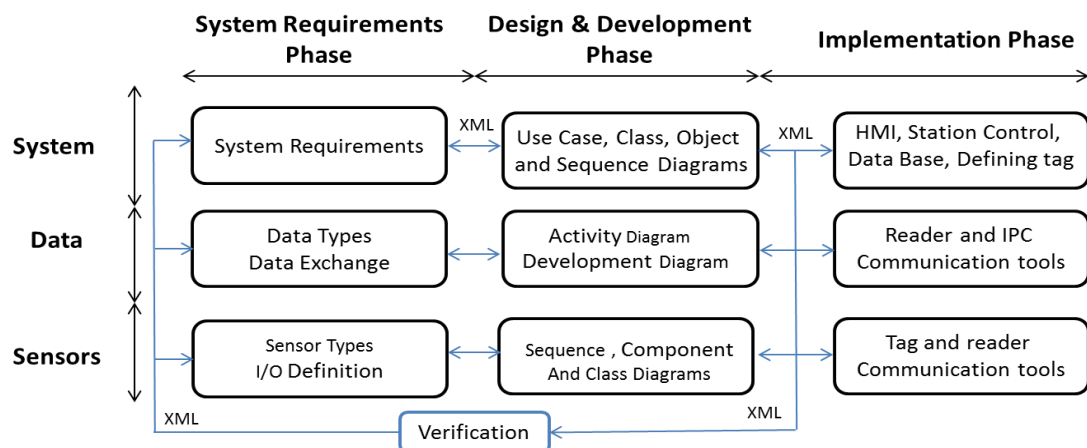

Figure 12: structural modeling for designing RFIDMAMs

The proposed architecture is composed of a system requirements phase, design phase and implementation phase, and each of these phases consist of level namely system level, data level and sensor level. These three types of the level is illustrated in the Fig 12 and relation between of this level with UML diagrams is depicted in it. In the system

requirement phase, the current system specification is captured holistically and problems that might be improved by RFID technology are identified. In the design and development phase, the manufacturing system is re-designed to address the problems identified in the system requirements phase. These results, at the system level, in a number of use cases, class diagrams, object diagrams, and sequence diagrams. At the data level, structural points are represented using cell activity and development diagrams. At the sensor level, the details of integrating RFID technology are captured through sequence, component, and class diagrams. A verification process ensures that the newly designed structure fulfills the requirements of the existing system. Ultimately, in the implementation phase, a hardware configuration and multi-agent framework are expressed at the system level, and interaction details are provided at the data and sensor levels. The implementation phase is important part of this methodology like with other one. It is shows that implementation of this new types of system is very costly and risky. For validation of proposed architecture flexible manufacturing system lab in EMU used as case study and RFIDMAMs was design and developed for this lab. Therefore the proposed architecture is defined as follow; First step of this architecture is system requirement phase, which is focused on the requirement of the existing system. The FMS laboratory at EMU was designed for education and research purposes. It is consist of three stations namely AS/RS station which is responsible for storing raw materials and product parts that is consist of 36 cells, machine station, robot arm, assembly machine and quality control system and also robot arm for handling materials. In the system barcode, technology is used for identification of parts type. The centralized connection based system is depicted in Fig 13.

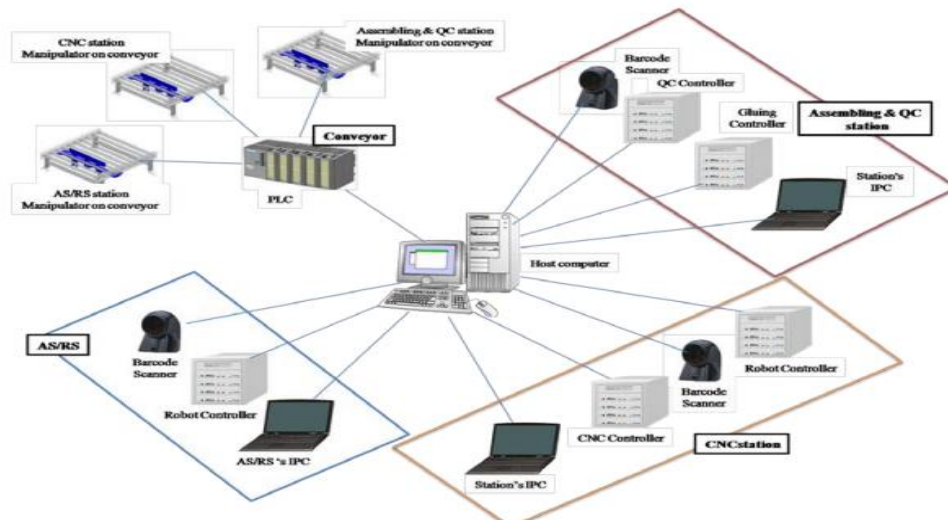

Figure 13: the connections and hierarchical relationships of the FMS

The problems with the current control architecture that might be improved by RFID and multi agent technologies are as follow:

- The manufacturing system is controlled by a centralized architecture running on a single host computer, from which all control decisions are issued.
- The stations have no autonomous control unit for their operations.
- The barcode technology cannot provide real-time information on component presence/position or on production progress, and is not suited to tracking new products one-by-one.
- The system cannot be reconfigured and agile in real-time.

2.9.1 Design and Development phase

System level in this phase is used “use case diagram” of UML tool. It is suitable tool for working connections among the users and stakeholders of a system, and for demonstrating the structure and behavior of entities at the highest level of abstraction. Figure 14 shows schematically how the operator of the system can interact with the Human Machine Interface. In this diagram, abstract view of the system is presented.

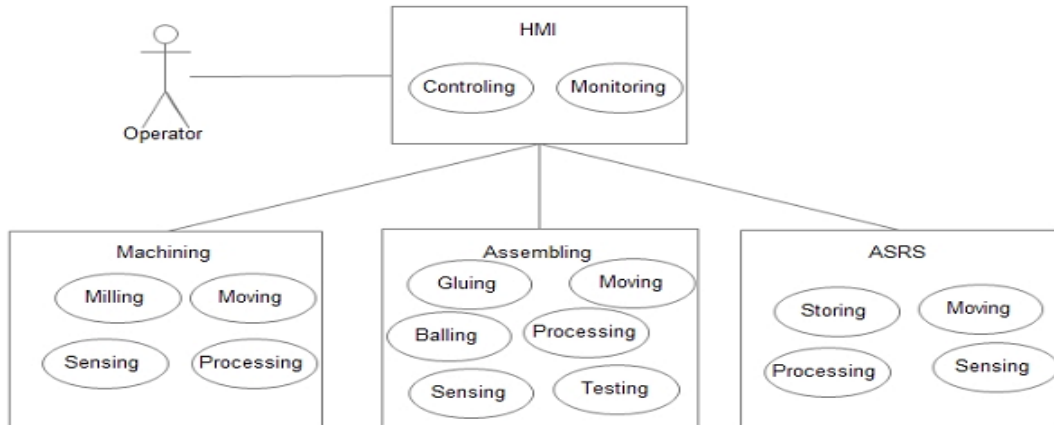

Figure 14: Shop human/machine interface

Static view of the system depicted by class diagram. Fig 15 is class diagram of the system that consist of main modules of the target system and their interconnections. The top part of this diagram shows the hierarchical model of a manufacturing facility, or ‘shop’. A shop can encapsulate a number of cells, each of which may contain several stations.

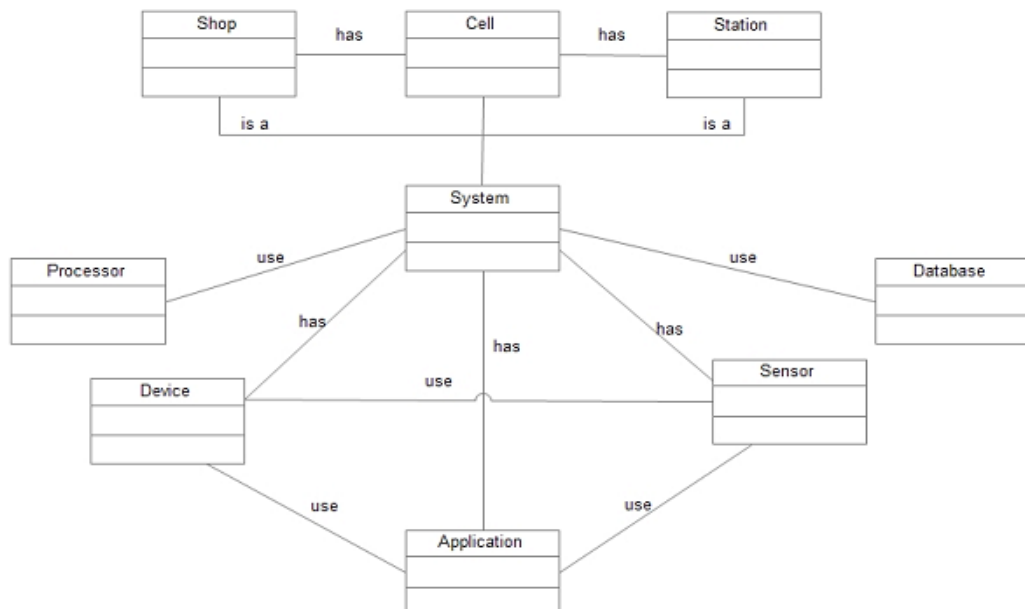

Figure 15: Class diagram of the system

A station contains several devices, applications, and an RFID-gate that integrates with a PC and connects to a data bus. The station's UML sequence diagram will help system analyzers and developers understand the dynamic behaviors of stations. A station receives messages from a part's tag and performs services accordingly. The station's RFID-gate then reads the same message and, based on its content, permits subsequent operations. Several operations based on the scenario can be executed in the machining, assembling, and AS/RS stations. A sample operation for the assembling station is illustrated in Fig 16.

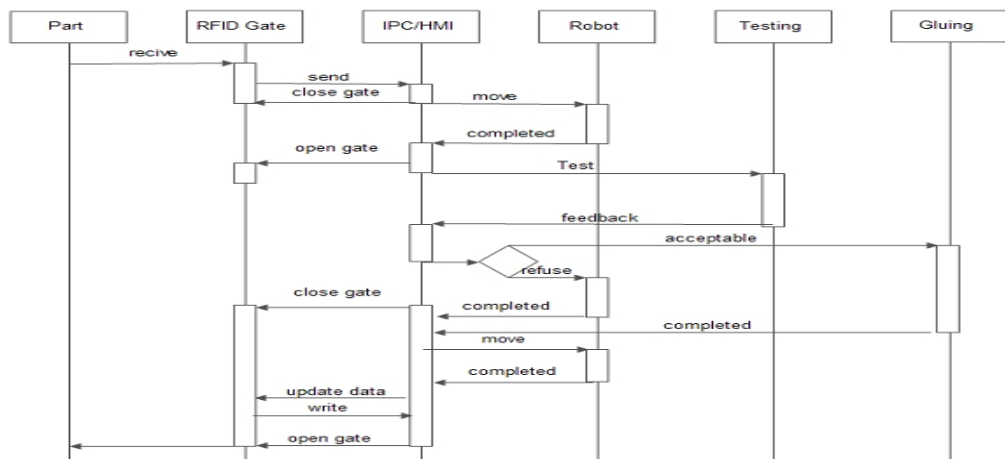

Figure 16: UML sequence diagram of assembling station

The data level presents the data flow and data connections among components. These may be expressed through structural and/or behavioral diagrams. The activity diagram of the cells can be modelling of behavioral of the system. Fig 17 is activity diagram of the system provides a perfect behavior of the system in the implementation view.

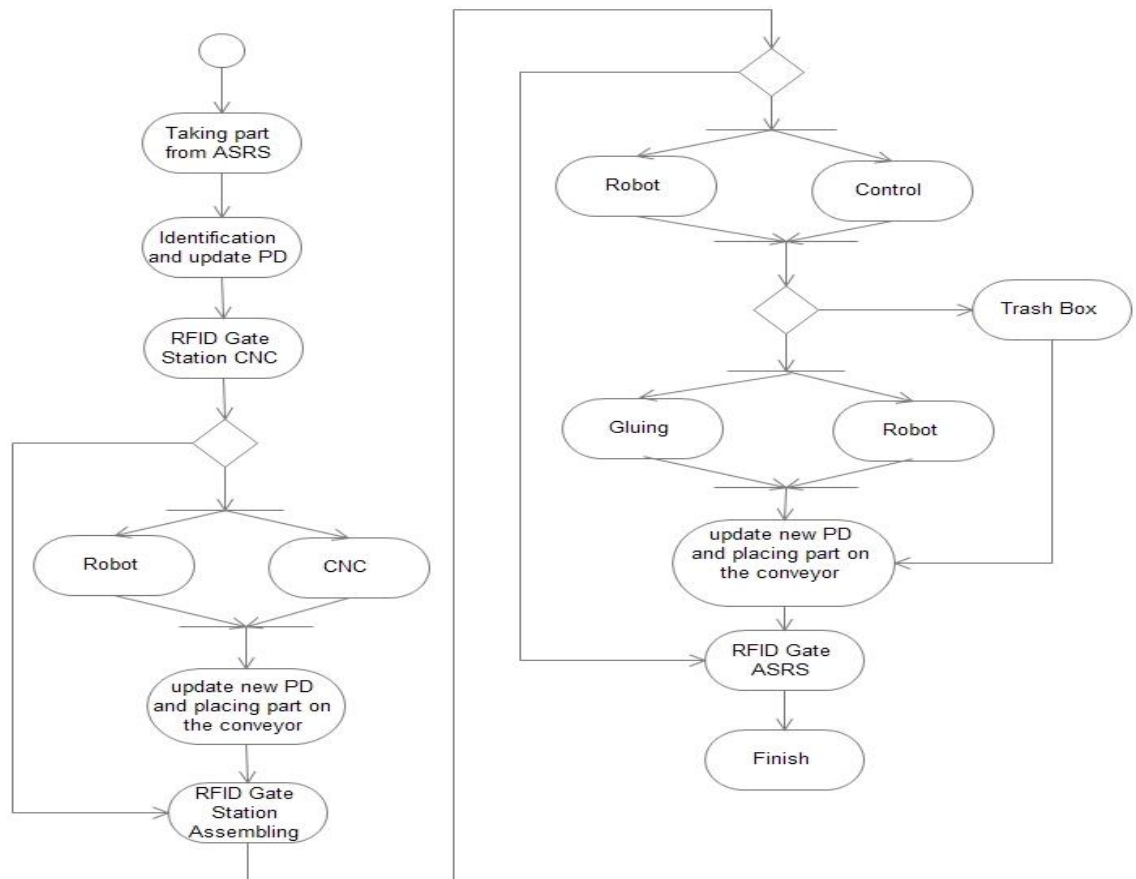

Figure 17: Activity diagram of the system

In the sensor level by integrating RFID technology in the shop floor, cause to real time data sharing in the shop floor, improve the data sharing, and make the intelligent part phenomena. In this way PD in wrote on the RFID tag, which can be updated based on real time system. Sequence diagram and component diagram is used for illustrated for RFID technology Fig 18 depicted sequence diagram of RFID gate.

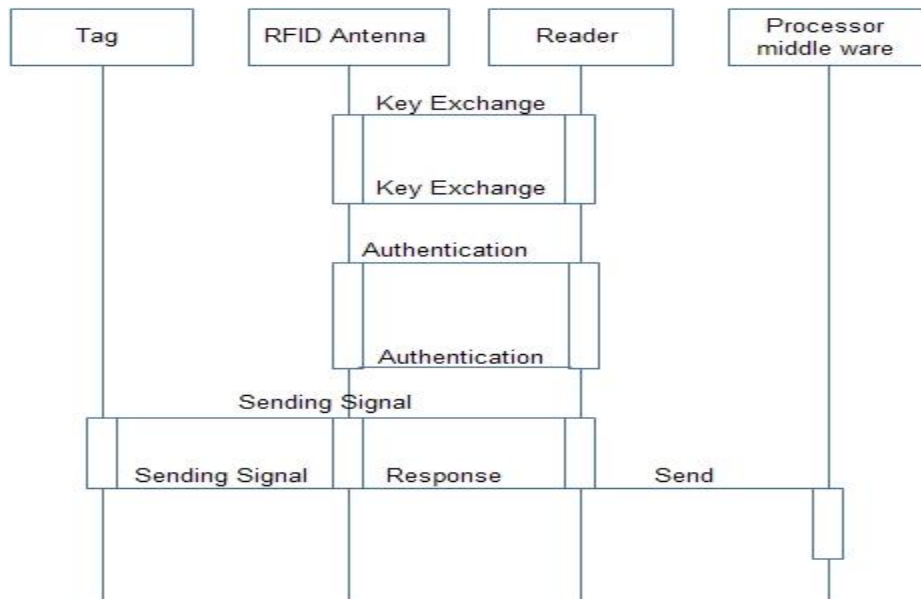

Figure 18: sequence diagram of RFID gate

2.9.2 Verification layer

The verification layer compares data generated during the as-is model or system requirement phase with data generated during the to-be model or design and development phase. This process helps to determine whether the designed model meets the problem definition. Extensible Mark-up Language (XML) is used to encode exchanged information (see Fig 19). The data file generated at the system requirement phase consists of three groups of information[85], namely supporting data structures, objects negotiation data structures and Manufacturing data structures.

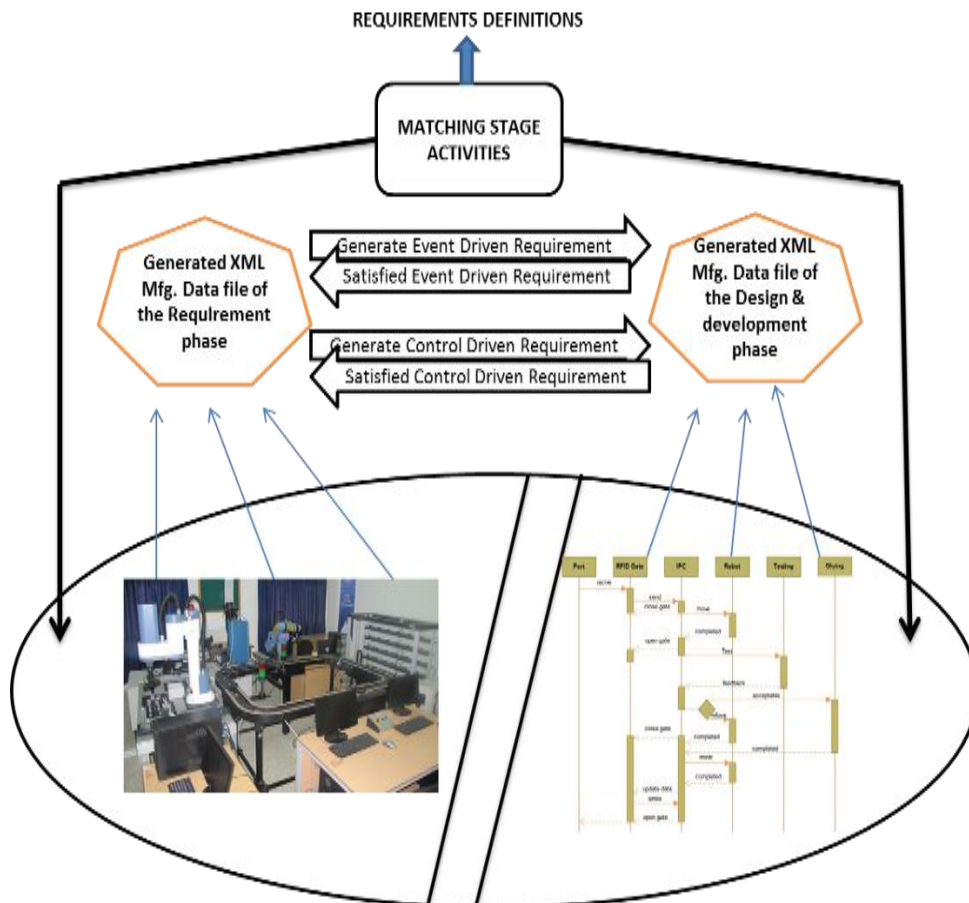

Figure 19: Verification layer

2.9.3 Implementation Phase

RFIDMAMs is designed as a network of software agents that interact with each other and with system actors. These agents include shop manager agent (SMA), agent manager (AM), shop monitoring and command agent (SMCA), station control agent(SCA), station monitoring agents(StMA), agent machine interface (AMI) and manufacturing resource agent(MRA). In the proposed framework shop database and station database are also exist for integration between agents. The agent types are determined according to their functions and respective system goals. In the proposed model, three groups of agents are introduced: physical agents (PA), execution agents (EA), information agents (IA). responsible for shop floor machines such as material-handling system, machines etc. Execution agents are responsible for carrying out

defined procedure and making decisions. Information agents, as the name implies are responsible for providing information or data to other agents to enable them to be aware of the change incurred.

Agent communication is probably the most fundamental features of the all agent-based platform, in this research agent communication is implemented based on FIPA. This communication paradigm is based on asynchronous message passing. Thus, each agent has a 'mailbox' (the agent message queue) where the JADE run-time posts messages sent by other agents. Whenever a message is posted in the mailbox message queue the receiving agent is notified. However, when, or if, the agent picks up the message from the queue for processing is a design choice of the agent programmer. This process is depicted in Fig 20. The particular format of messages in JADE is compliant with that defined by the FIPA-ACL message structure.

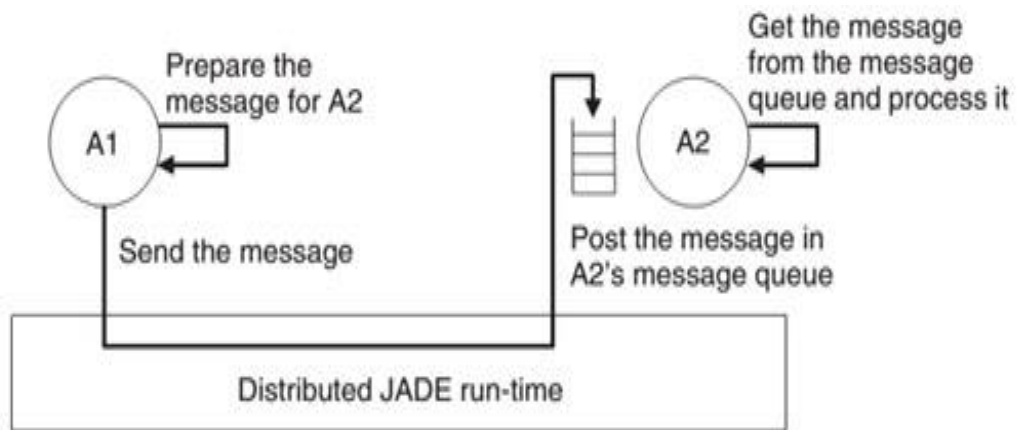

Figure 20: message structure of FIPA-ACL[86]

Direct communication agent in the FIPA-ACL is used and each agent send directly message to each other. The RFIDMAMs control system prototype was implemented in the FMS lab of EMU, to take advantage of the modularity, flexibility, decentralization and reusability inherent to the multi agent approach. The Java agent

development framework (JADE)[86], was chosen from the set of commercial and academic agent development platforms. JADE provides a set of system services and agents in compliance with the FIPA specifications, such as naming service and yellow-page service, message transport and parsing service, and a library of FIPA interaction protocols ready to be used. An interesting comparative study of the available agent development platforms is presented in [77]. Fig 21 depicted the agents in the RFIDMAMs.

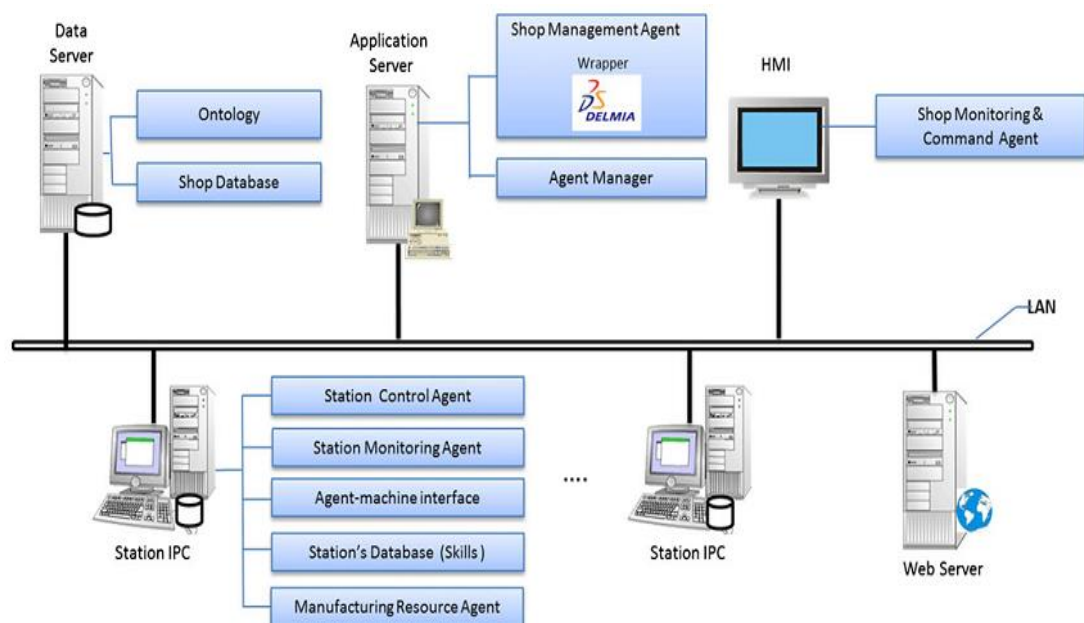

Figure 21: Multi agent system architecture of RFIDMAMs

An ontology defines the vocabulary that will be used in the communication between agents, and the knowledge relating to these terms. This knowledge includes the definition of the concepts and the relationships between these concepts. The meaning of the message content is captured in the message ontology. The developed ontology was designed using the Protege tool [87] and translated into Java classes using the Ontology Bean Generator plug-in, according to the JADE guidelines that follow the FIPA ontology service recommendations specifications.

2.10 Limitations and Challenges of the Existing Approaches

Decentralized approaches, such as MAS, address better the disturbances situations but design and implementation of such system require risky careful decisions to ensure that the highly automated manufacturing system will successfully satisfy the demands of an ever-changing market. The behavior of MAS is not deterministic. Yet the direct experimental testing of it with the physical manufacturing/ control environment being involved is not only extremely expensive but nonrealistic as well. Hence the manufacturing companies need methods and tools for implementing their manufacturing systems. In a quick, cost effective, error and risky freeway by considering all types of disturbances. Although, there are various simulation methods, commercial applications available for design, and analysis of integrated manufacturing systems, they generally do not fully cover the aspects related to MAS based manufacturing system. In addition the commercial software package require long trained experts for operations and the high purchase costs, which are not affordable especially by SMEs. However analyzing the current state-of-the-art of the agile manufacturing it can be found that limitation of the existing of this filed can be categorized in the three parts;

- 1: existing agent based manufacturing system consider machine disturbances in the system and they are not consider customer demand disturbances.
- 2: existing agent based manufacturing system, lack of self-organization that reduced the optimization of the whole system.
- 3: insufficient simulation platform for implementing agent based manufacturing system.

2.11 Summary

This chapter overviews the current state-of-the-art concerning the manufacturing control architectures and simulation platforms. The different system configurations were depicted and analyzed, enhancing their benefits and disadvantages. The limitation of the existing simulation platform and approach for designing an agent based manufacturing system is explained in the detail. This chapter provided valuable info about the strengths and weaknesses of these manufacturing control and scheduling architectures and simulation platform. It was not found an architecture that allows the entities to dynamically adapt its internal and external behavior and the majority of them consider just a machine disturbances in the system also they are not improve the self-organization of the proposed agent based system.

Chapter 3

DESIGN AND DEVELOP A NOVEL AGENT BASED AGILE MANUFACTURING SYSTEM

3.1 Overview

In this chapter, we highly focus the design agent based agile manufacturing system for real company by considering both machine disturbance and customer demand. This chapter introduces a multi-agent-based dynamic planning system using the Prometheus Methodology (PM). The PM is used for designing a decision-making system with the feature of simultaneous dynamic rescheduling. The case study based design and development system is used in this chapter. The real company “uPVC door and window” is used as a case study for designing and develop of proposed system. The application has been completely modeled using a Prometheus design tool, which offers full support to the PM, and implemented in JACK agent-based systems. The proposed decision-making system supports both static and dynamic scheduling. The proposed simulation platform in the last chapter is used for testing the proposed multi-agent system (MAS), and two real scenarios are defined for evaluating the proposed system.

3.2 Introduction

Over the last decade, small and medium-sized enterprises (SMEs) have gained importance, indicating the economic growth of a country. In addition, larger establishments have lost ground in terms of market share and employment[92].

Scheduling and control problems in the SMEs differ from that of the large-sized enterprises in three ways. First, in SMEs, an order is accepted based on the availability and capacity of the right type of capability. Second, the number of job types is much higher than the large enterprises, and consequently, the amount of manufacturing data to be generated per unit of work is very high. Third, the demand is dynamic[93]. Therefore, the process planning and continuity of activities aiming at the flexible use of the manufacturing equipment and human resources is a vital concern[94, 95]. The conventional scheduling systems in SMEs have the following issues [2, 96]:(1) The systems are not reactive to parallel requests the conventional systems are typically unable to manage a set of simultaneous events that must be addressed. (2) Lack of distribution. The scheduling and control system uses a centralized decision support system, which is located on a host computer. (3) Weak response to reconfiguration in the case of disturbances even though a large number of internal and/or external disturbances may occur in the system.

A dynamic planning system (DSS), which allows enterprises to optimally match the desired customer demands with their plans, is a time-dependent system[97]. In this system, decisions are taken based on the correctness of both logic and time, resulting in a considerably increased scheduling efficiency[98]. The logic correctness fulfills the constraints with respect to the resource capacity and order of operations, whereas, time correctness satisfies the time-based constraints such as interoperation and due dates[95]. DSSs are appropriate for systems with several internal and/or external disturbances (e.g. order changes and machine failures)[33]. In the literature, two different approaches are mainly used for solving the dynamic scheduling problems in the agile manufacturing, namely, dynamic planning-based approach and dynamic best effort approach[50]. In the dynamic planning-based approach, scheduling starts when

a job arrives, and the job is accepted only if timeliness is guaranteed[99]. Whereas, in the dynamic best effort approach, the ability to schedule a job is not checked[100]. According to Yoon and Shen[101], DSSs can be categorized into hard and soft deadline systems. In the hard deadline systems, time correctness is crucial for all decisions, whereas in the soft deadline systems time correctness is important but not crucial. Hence, dynamic scheduling for manufacturing flow lines (MFLs) is adequate for hard time-dependent systems and requires a dynamic planning-based approach[102]. A dynamic planning-based approach with dynamic customer demands, mainly reported in the computer science literature, is studied to allocate a central processing unit (CPU) and memory space, and a job typically requires only a single resource. For instance, Ramamritham et al.[103] proposed a scheduling algorithm for real-time multiprocessor systems with hard deadlines. The scheduling algorithm uses a search option to find a feasible schedule. Unlike the examples in the computer science literature, the resources in MFLs include machines and material handling systems (MHS), and a job typically uses a subset or the entire set of resources. Recently, agent technologies have been applied for dynamic planning-based scheduling in manufacturing systems. For example, Yoon and Shen[104] constructed a multi-agent system (MAS) for scheduling a semiconductor manufacturing factory in which four types of agents were designed and developed. A scheduling agent determined an optimal scheduling plan by estimating a few possible scenarios.

The MAS provides a new method for solving distributed, dynamic scheduling problems in the agile manufacturing system. Extensive research literatures exist, which address many scheduling issues of modern manufacturing companies with agent technology[105, 106]. The MAS has often been employed with a Contract-Net negotiation protocol[62] for solving various problems of scheduling and failure

handling in manufacturing tasks. For scheduling manufacturing tasks, Valckenaers and Van Brussel[107] have utilized an agent-based decentralized manufacturing execution system composed of exploring ant agents for providing a look ahead into dynamic resource scheduling problems. Kaplanoğlu[108] proposed a real-time scheduling system based on the multi agent system, which is least sensitive to the fluctuations in demand or available vehicles than the traditional transportation planning heuristics (local control, serial scheduling) and provides flexibility by solving local problems. To set up dispatching rules, Chen et al.[109] implemented a distributed agent-based system by applying a multi-agent technique to a multi-section flexible manufacturing system, which assists the agents in choosing suitable dispatch rules pertaining to the dispatching region and resolves the entire dispatching problems of a manufacturing system by agent cooperation. In most of the existing literatures, a specific methodology is introduced for the design and development of the MAS, whereas for agile manufacturing, it is not possible to employ a new methodology for the development of the MAS because of the limited budget of the SMEs. The best way to overcome this concern is to use a general-purpose design methodology[110]. An effort in this regard can be found in[111].

The literatures indicate that there are some valuable efforts in the design and development of DSSs using the MAS with general-purpose methodologies or specific methodologies[112, 113]. This chapter presents a multi-agent-based DSS for agile manufacturing system in the SMEs by considering both together the dynamic customer demands and internal disturbances.

3.3 Prometheus methodology

The PM is a general-purpose design methodology for developing software agent systems in which it is not tied to any specific model of the software platform[114]. The PM defines the detailed processes for specifying, designing, implementing, and testing/debugging agent-oriented software systems. In addition to the detailed processes (and several practical tips), it defines a range of artifacts produced during the processes. The PM consists of four steps, three of which deal with the design of the agent-oriented software and the last step deals with the implementation of the system. In this chapter, JACK is selected as a platform for implementing the proposed MAS. Fig 22 illustrates the design steps of the PM.

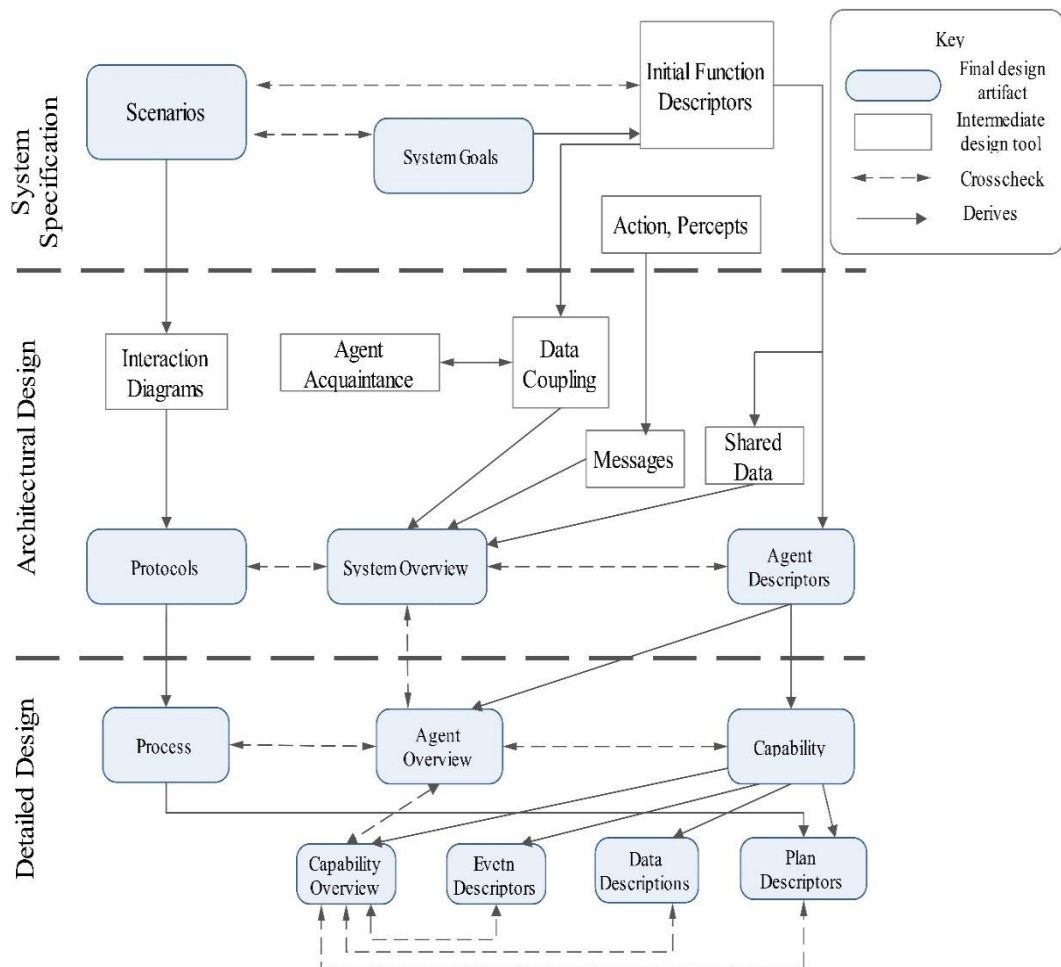

Figure 22: Design steps of the PM [114]

As shown in Fig 22, the design steps of the PM are as follows[114] .

- The system specification phase focuses on the identification of the goals and basic functionalities of the system along with the inputs (percepts) and outputs (actions).
- The architectural design phase uses the outputs of the previous phase to determine the types of agents in a system and their interaction.
- The detailed design phase focuses on the internals of each agent and the ways to accomplish the tasks of the agents within the overall system.

By adhering to the PM, the first step is to define the system specification. The system specification defines the actors participating in the system, describes the scenarios of participation by defining the initial functionality descriptors, and finally identifies the system goals. The actors are the entities using the system or interacting with the system in some way. The scenarios describe the occurrence of interactions [115]. The next step is to identify the tasks for each of these actors. The designer can identify the scenarios that each agent may act upon by elaborating the tasks assigned to each actor in the system. After identifying the scenarios, the designer can use them to determine the goals of the system. From these initial goals, the designer can determine the additional sub goals. The goals are grouped into similar functions, and the duplicate goals are removed. The intention is to describe the functionality descriptors of the system. The next step is to identify the precepts in the system. The precepts are the types of information input to the system from the external environment. The designer can identify the precepts by studying the previous artifacts. The next stage in the system specification process is to describe the actions. The actions are defined by the information sent from the system to the external environment. The final stage of the

system specification process is to develop the initial functionality descriptors. This groups the actions, precepts, and goals into a description that can be used in the future design. Once the system specification is defined, the architectural design of the system commences. The data-coupling diagram can be produced from the initial functionality and data descriptors developed as a part of the system specification. The next step in the architectural design is to identify the agents existing within the system and create an agent acquaintance artifact. After defining the agents, in detail design stage the interactions between these agents can be defined. This is done with an interaction diagram and a protocol diagram. Additional interaction diagrams are produced for each scenario represented in the analysis overview diagram. The interaction and protocol diagrams describe the scheduling problem that must be coordinated among the participants in the process. It should be noted that the following artifacts produced using the PM were not produced in the first attempt[116]. Therefore, the artifacts and descriptions in this paper are the results of several iterations over the same problem each iteration refines the design until an acceptable solution was obtained.

3.3.1 Case study and design of the proposed multi-agent system

Yaran Bahar Golestan (YBG) is a small enterprise that produces make-to-order unplasticized polyvinyl chloride (uPVC) doors and windows by using automated machines. YBG is located in the north of Iran and provides doors and windows mainly to the internal market orders. The company has two main departments: manufacturing support and management department located in a downtown and an MFL located a few kilometers away in the industrial area. The manufacturing support and management department is in charge of the design, production planning and scheduling, and marketing of the products. Moreover, finance and administrative sections are included in this department. The production process of the MFL involves

the production of the frames of windows/doors and several assemblies in addition to the test and quality control phases. Fig 23 shows the layout of the uPVC part of the MFL.

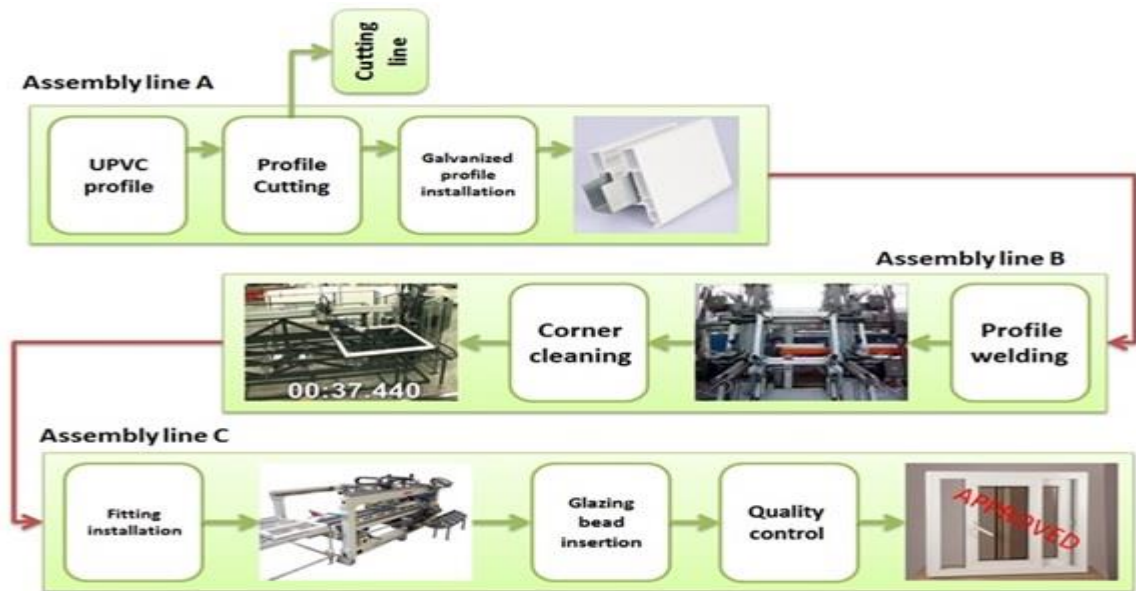

Figure 23. Layout of the manufacturing MFL of YBG

The window components, such as fittings, profiles, and glasses, are provided by partner companies according to the windows/doors design specifications. The window frames are manufactured in the MFL. Nearly, fifteen models of doors and windows are under production: tilt and turn windows, slide hung, top light, sliding–folding, center hinge/pivot, etc.

3.3.2 System specification design

The system specification phase is the first part of the PM. The system specification design phase consists of four sub phases: analysis overview, scenario overview, goal overview, and system role overview. System goals are specified in the goal overview diagram, resulting in a list of goals and sub goals with associated descriptors. This phase is responsible for the identification of system goals, development of a set of

scenarios that have adequate coverage of the goals, identification of functionalities linked to one or more goals, negotiation among the types of agents, and determination of the scenarios of the system. Figure 24 shows the goal overview diagram of the system.

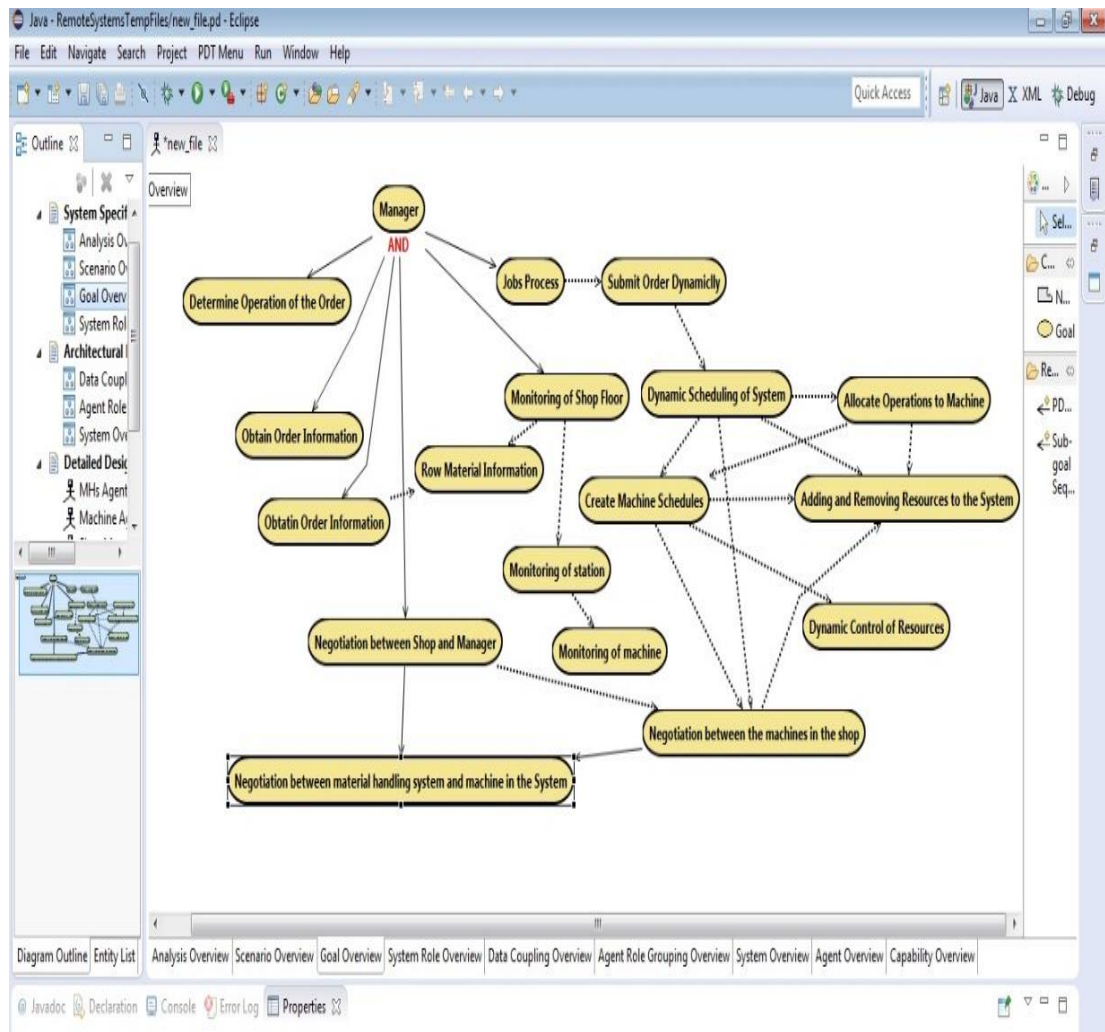

Figure 24: Goal overview diagram of the system.

The scenario overview phase was developed by a set of scenarios having an adequate coverage of the goals providing a process-oriented view of the system to be developed. The system role overview defines a set of functionalities linked to one or more goals and captures a piece of the system behavior. Fig 25 shows the system role overview in

which there are four main roles: manager role, shop management role, cell role, and negotiation management role.

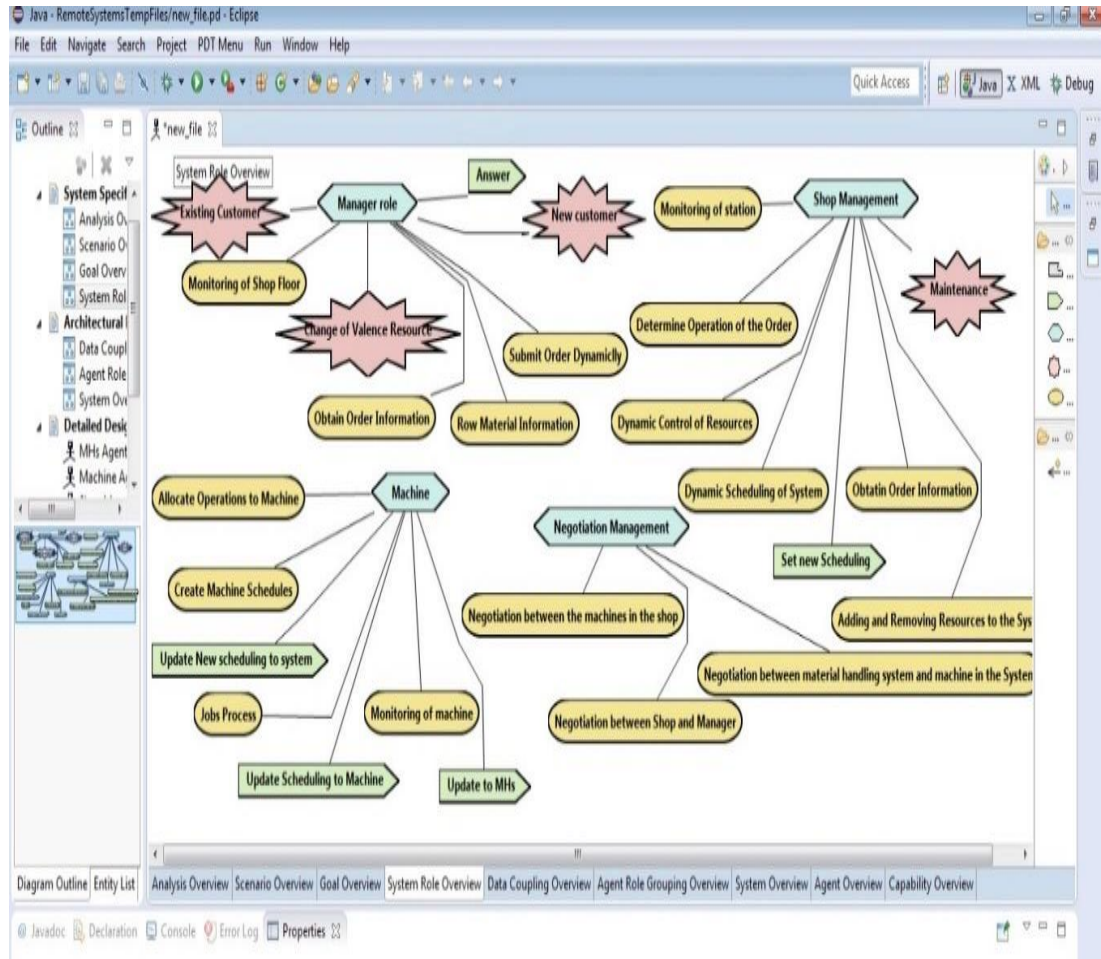

Figure 25: System role overview

The sub goals are also designed in the system specification stage. For example, four sub goals of machine scheduling after the arrival of unpredictable orders are defined: the machine is busy and has a task, the machine is free and has a task, the machine is free and has no task, and the machine is loaded and has no task.

3.3.3 Architecture design

This stage identifies the types of agents according to the PM in which the roles of the agents in the system are determined. This phase consists of three parts: data coupling overview, agent role grouping overview, and system overview. The negotiation

protocols for the agents are designed in this phase. A system overview diagram is illustrated in Fig 26. All the agents are defined in this stage: manager agent, shop manager agent, cell agent, MHS agent, scheduler machine agent, MHS resource agent, and machine resource agent. The last two agents are interface agents and the other five agents are software agents used for the dynamic scheduling decision-making system. The proposed system follows a top-down approach by considering the real-time negotiation between all types of agents. The negotiation protocols of the agents are shown in Fig 27 using arrows. Protocols consist of an order protocol, shop protocol, MHS negotiation protocol, machine negotiation protocol, resource protocol, and machine resource protocol.

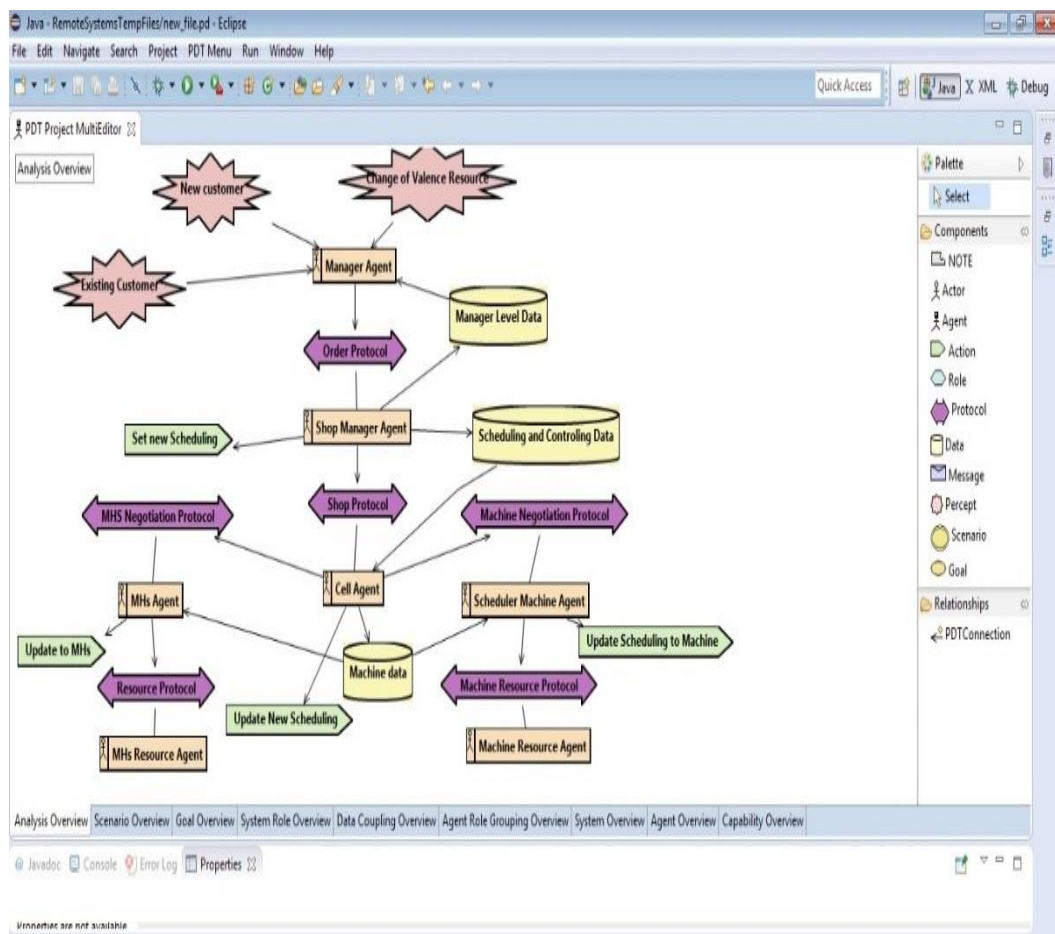

Figure 26: System overview diagram in the architectural design stage

In order to describe all the interaction protocols, we developed the interaction protocols depicted by using the agent UML (AUML). Figure 28 shows an example of the negotiation protocol corresponding to the cell agent, scheduler machine agent, and MHS agent. This shows the negotiation between the cell agent and the scheduler machine agent for updating a new schedule in the machine and the concurrent communication with the MHS for transferring the material to the machine. This communication between the machine agent and the MHS agent is initiated by an MHS negotiation protocol. These negotiation protocols are coded in the Prometheus TM software.

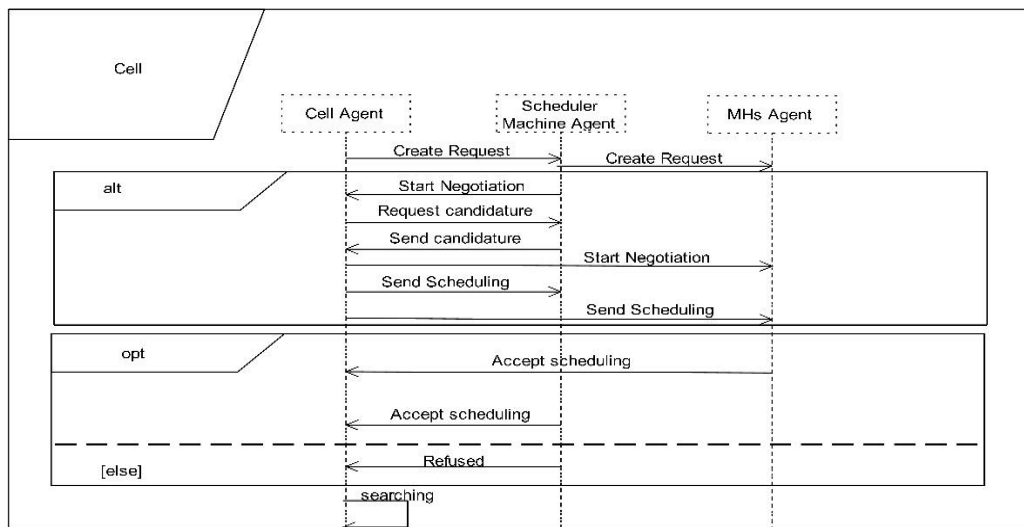

Figure 27: Negotiation between Cell Agent and Scheduler Machine Agent.

5.3.4 Detailed design

In this stage, a detailed design is developed for each type of agent. The agents receive messages from the main platform event of their environment or other agents, which operate on their plans; thus, they act according to the records in their database.

For example, the manager agent manages the customers and updates the new orders to the system. The manager agent uses its belief sets, plans, and message events to accomplish this task. The architecture of the manager agent is shown in Fig 28 in the form of a Prometheus™ design view.

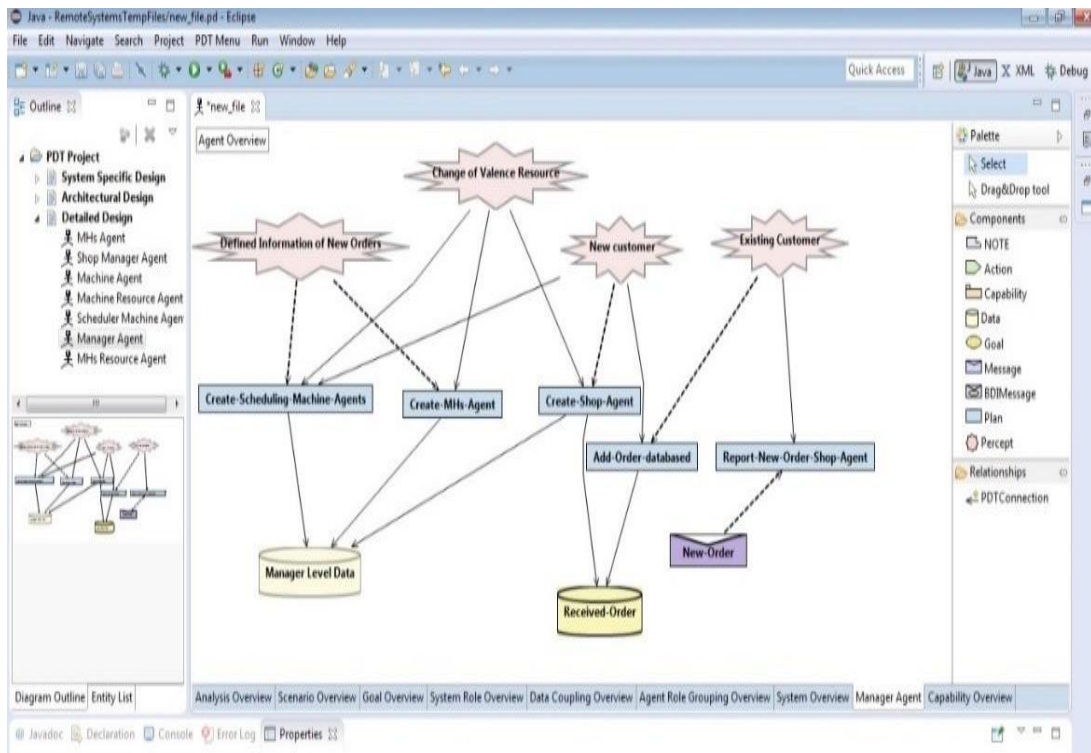

Figure 28: Manager Agent architecture

The other agent playing an important role in the rescheduling and dynamic scheduling of the cell level is the scheduler machine agent. This agent consists of two databases: machine status and machine negotiation results. The detailed design of this agent is illustrated in Fig 29.

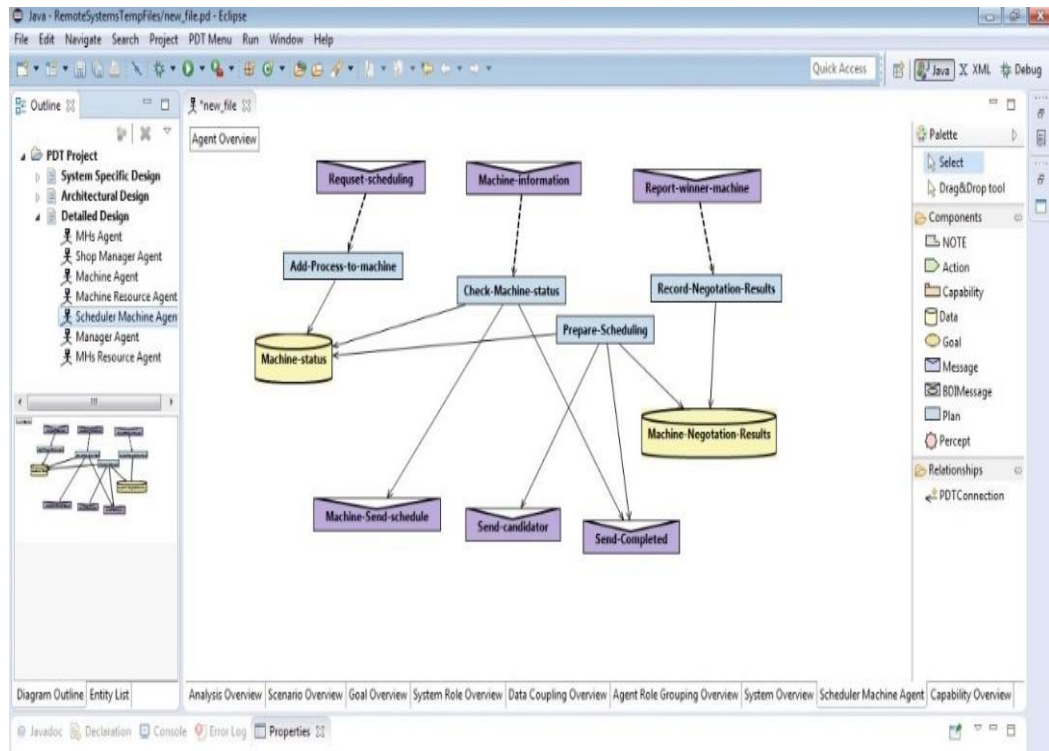

Figure 29. Detailed design of scheduler machine agent

5.3.5 Decision-Making Mechanism or Rescheduling

An algorithm for rescheduling the system for dynamic customer demands is proposed in this section. Figure 30 illustrates the sequence of the decision-making mechanism in the proposed MAS. The manager agent informs a new or unpredictable order to the shop manager agent. The shop manager agent sends the related questions to the cell agent, and this agent sends the questions to the scheduler machine agent and the MHS agent. The scheduler machine agent communicates with the machine resource agent in real time and sends the related information to the cell agent. This agent by considering the information from the scheduler machine agent answers the questions posed by the shop manager agent. The shop manager agent by considering the information from the cell level takes a decision and informs to the manager agent. If the manager agent confirms this decision, it will send the related information to the shop manager agent. The shop manager agent creates a new schedule and a new subagent and sends them

to the cell agent and the MHS agent. The cell agent sends the new data to the scheduler machine agent, and this agent updates the new schedule to the machine.

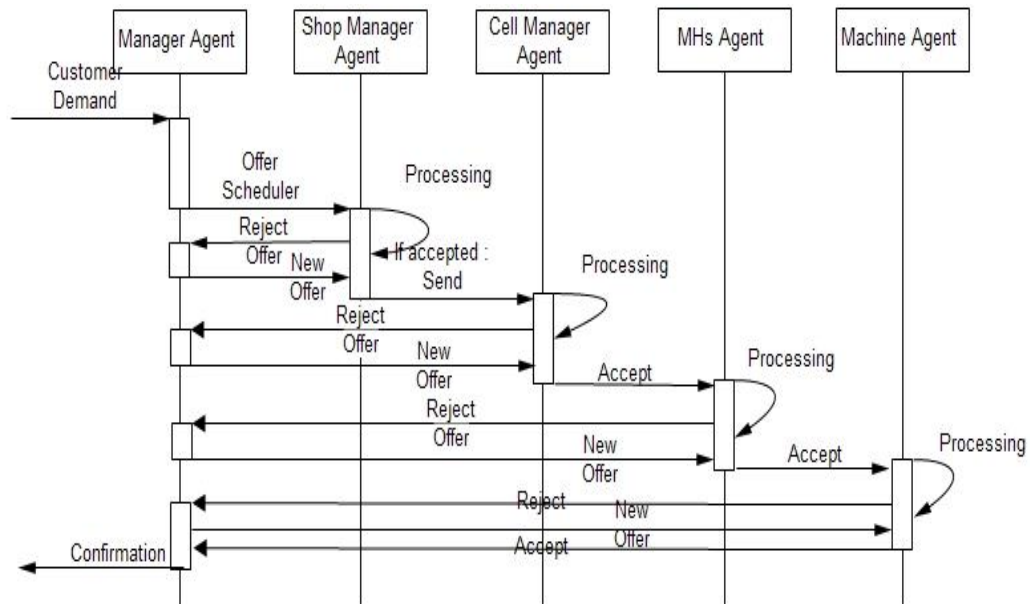

Figure 30: Sequence diagram of decision-making mechanism

5.4 Implementation

The generation code and implementation software were started manually from the design stage. This makes it possible to diverge the design and implementation stages[117] and generates a gap between them[118]. To bridge the gap, a methodology introducing refined design models that can be directly implemented in an available programming language should be used. The PM follows this approach, which is an advantage of this methodology. The last stage (the detailed design phase) of this methodology offers the models sufficiently close to the concepts used in a specific agent-oriented programming language named JACK[119]. Hence, the entities obtained during the design can be directly transformed into the concepts used in JACK. Table 5 shows the Prometheus entities being translated into their equivalent JACK concepts. It should be noted that some entities (actor, goal, protocol, role, and scenario)

are not transformed into JACK concepts. The action concept is not transformed into a JACK-specific concept, but it can be implemented in the associated agent as a method.

Table 4: Mapping Prometheus modeling concepts into JACK concepts

Prometheus entity	JACK concept
Agent	Agent
Capability	Capability
Percept	Event
Plan	Plan
Data	Belief Set
Action	---

Figure 31 illustrates a systematic method for the code generation process. This process generates a code by using the Prometheus design tool (PDT) and converts this code into a JACK concept. The user can press the generate button in the code era catalog (JACK) to generate a JACK folder, which contains several subfolders (agents, capabilities, data, events, and plans), automatically. The same occurs for the capability, data, message, and plan entities created in the model except for the file extension and folder, which are sorted as depicted in the tree diagram of JACK in Fig 31.

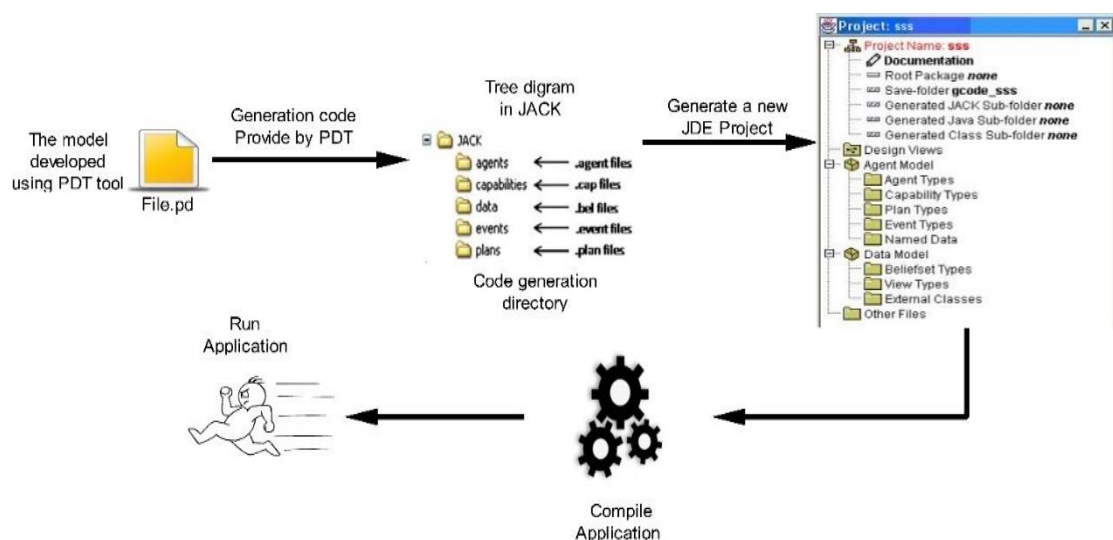

Figure 31: Code generation process

A JACK developer environment (JDE) was used to import the code generated by the PDT. For this process, according to [118], five steps are followed: a) The compiler utility submenu available in the tools menu is chosen in the JDE. b) The Convert Non-JDE JACK is selected for converting the existing JACK code. c) The folder that contains the code generated by the PDT is introduced into a content list. d) After defining the address and folder name, the generate button is pressed, and the new JDE project will be obtained.

Presently, the inside structure of the documents and their augmentations are distinctive with a specific end goal readable by the JDE. Lastly, after generating a few Java classes and finishing the generated gcode, the JACK program can be easily transferred into Java using the facilities provided by the JDE and executed. By using the customer demands, the manager agent creates a list of operations. In addition, the available schedule is chosen from the list. When a schedule is created, the selected order information is sent to the shop manager agent. After the shop manager agent accepts this schedule, a new order is sent to the cell manager agent. The cell manager agent cooperates with the required equipment, which provides transportation, and raw materials and communicates with the machine agent and the MHS agent, which help in the completion of the work during execution.

3.6 Summary

The dynamic planning method is widely used in the agile manufacturing system. This chapter attempts to solve the planning problems of the agile manufacturing by using a multi-agent-based DSS. The proposed system is designed and developed in order to solve scheduling complexities during a dynamic order change and occurrence of internal disturbances in the real company. The design uses the capabilities of the MAS

in order to solve real-time scheduling complexities. Feasible and effective schedules are expected from negotiation/bidding mechanisms between agents. In this chapter, we tried to clarify the problems of a manufacturing system and how the MAS can be helpful. The MAS scheduling and control system is designed based on the PM and implemented in the JACK platform. A real case study was used for designing and developing proposed system.

Chapter 4

IMPROVING SELF-ORGANIZATION OF AN AGENT BASED MANUFACTURING SYSTEM

4.1 Overview

This chapter focused on the improving the multi agent, based agile manufacturing controlling and scheduling system. Nowadays, manufacturing control system struggle to adopt agile manufacturing system. The end goal to adapt to today's dynamic environment, the described manufacturing control system is designed as a multi-agent system (MAS). In previous chapters, a novel multi agent based control system was proposed such as RFIDMAM and a novel agent based manufacturing scheduling in chapter 4. These agent base systems are design and developed based on agent technology but all agents were coordinated by direct coordination mechanism (DCM). The DCM decreased decision-making response to disturbances in the system and made agents spend more time on processing messages than doing the actual job; therefore, this chapter proposed indirect coordination mechanism (IDCM) between the agents based on ant colony intelligent (ACI), which could improve the self-organization and time processing of the system. Ant colony intelligent agent was proposed by taking advanced of stigmergy mechanism. In the new architecture, the ant agent was created by the existing agents to indicate communication between the agents. The proposed new system used RFIDMAMs as a reference architecture and implemented at this

architecture for validity of propose system flexible flow line manufacturing system used as case study.

4.2 Introduction

The 21st century has witnessed an explosion of technological advancement in various sectors of the economy and this technological advancement has been a part of the benchmark in defining any successful economy. Over the years, the manufacturing industry has evolved its manufacturing methodology in order to meet up with the standards of the client demands and market dynamics. However, the manufacturing system is faced with the challenge of adopting an agile manufacturing system[121]. The past manufacturing systems based on the central decision-making unit and inflexible control structure can be no longer managed with these demanding limitations [122]. These conditions create the need for a new design of a manufacturing control system that will be able to cope with such circumstances effectively and efficiently [123]. In other words, to cope with the dynamic nature of the environment, nowadays, manufacturing control systems is redesigned using artificial intelligent (AI) systems.

Previous studies on this subject have been primarily focused on moving away from traditionally centralized system forms to incorporating multiple decision-makers that can be arranged via various coordination systems [124]. In this respect using new technology such as radio frequency identification (RFID) for collecting data with high efficiency and probability in the manufacturing system [125], RFID technology with the MAS provides an opportunity to gain precise and timely data acquisition. MAS and RFID form bi-level twinned systems, which could overcome each other's shortcomings [126]. In the last chapter RFIDMAMs is propose. The coordination

system between the agents in this system like other MAS-based manufacturing system is based on the DCM such as contract net protocol (CNP) [127]. However, the DCM between the agents decreases the agent decision-making response to disturbances in the system and increases the time of processing messages in the MASs [80]. This chapter is focused on developing a more agile agent-based control system for dynamic manufacturing system. The goal of this chapter is to improve the global performance of multi-agent manufacturing control systems by introducing IDCM into agent negotiation based on the ACI. Therefore, the proposed systems could not utilize direct coordination, but indirect coordination with an emphasis on Stigmergy mechanism.

The contract-net protocol (CNP) is the most common coordination mechanism [127]; this protocol has four steps namely [121]; "task announcement", "bidding", "awarding" and "expediting". the modified versions of this protocol have been proposed by many researchers, which include market-based [128], auction-based [129] , and game theory-based [130] coordination. In the CNP, an agent declares the handiness of tasks, transmits them to other bidding agents, chooses a contractor, and lastly awards the task by comparing bids corresponding to a specific proposal by means of the predefined criteria. Keeping in mind the end goal to control the negotiation more efficiently, various market-based and auction-based negotiation mechanisms have been developed based on the CNP. All of the overhead methods are types of DCM and have a similar drawback in communication. This limitation in the communications decreases the agent's decision-making response to disturbances in the system and provides more message processing time for agents than doing the actual job. Nowadays, social insects like ants, bees, termites, and wasps offer us another demonstration for coordination in complex systems [131-134]. Colony is the most interesting adjective of social insects; it is a highly autonomous distributed system with cooperative

intelligence. In fact, everybody knows that an insect has limited intelligence, but together, social insects are capable of reaching great things or their colonies are intelligent. Moreover, the cooperative intelligence in the colony is realized most of the time. Investigations on biological insect societies display that these animals coordinate themselves by producing a dissipative field in their environment. Ants interact by spreading smelly chemical pheromones into their neighborhood during their activities. This insect behavior has inspired a new field of research, which is known as ant algorithms [135]. Fig 33 illustrates the indirect communication in food foraging of ant colony.

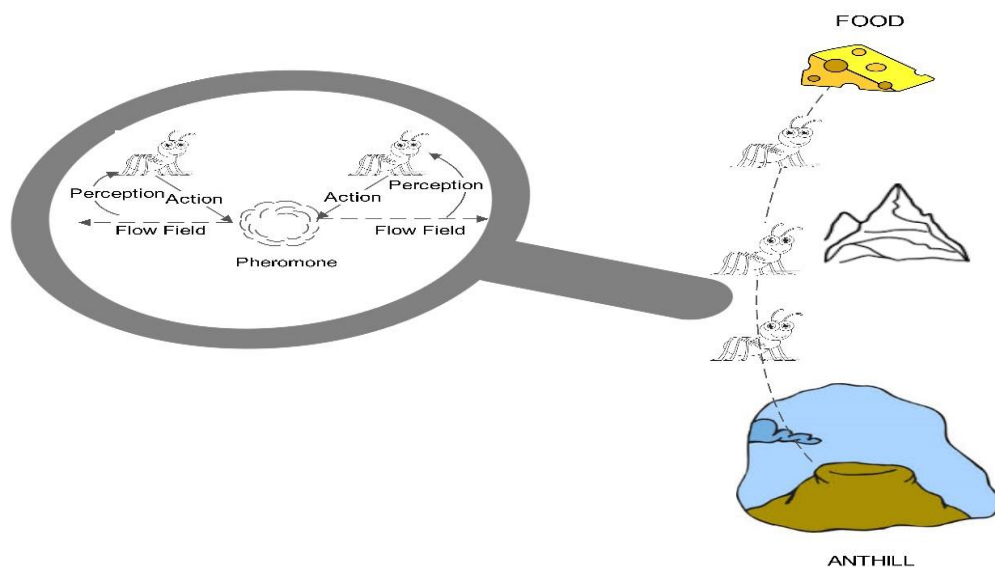

Figure 32. Illustrated indirect communication in food foraging ant colony

An application of this algorithm is the ant system (AS) [136]. In the computer science, this mechanics is called stigmergy mechanism [137]. Stigmergy is now one of the key concepts in the field of swarm intelligence [138]. Nowadays, stigmergy is a mechanism of indirect coordination between agents or actions [124]. This mechanism is an alternative method to the problem of infusing local shop floor decisions with more global performance information. It is merging to MAS structure, because it can

reduce communication among agents and make agents intelligent and flexible [139]. Many works have been done to apply ant colony and stigmergy mechanism to multi-agent systems [140]. Valckenaers et al. [141] explained the stigmergy mechanism in the HMS; in this study, they used stigmergy in the PROSA platform for improving self-organization of the existing system. Junhua et al. [142] proposed swarm intelligence for multi-agent systems based on stigmergy agent. Bonabeau et al. [135] developed a simple model for task allocation in ants based on the notion of response threshold and applied it to solve mailmen deliver work to realize adaptive mail retrieval. Their work followed a simple reinforcement process: a threshold was decreased when the corresponding task was performed and increased when the corresponding task was not performed. Gao [136] used pheromone mechanism in the ant foraging behavior, trying to tackle the difficulty of rising complexity and dynamics on the shop floor. W. Xiang et al. [80] applied ant colony intelligence for multi-agent dynamic manufacturing scheduling. Tripp [143] applied stigmergy mechanism to multi-platform cluster control system and permitted for infrequent communication with decisions based on local data and ground stations occasionally adjusted parameters and disseminated a “common environment”.

4.3 Design of RFIDMAMs with Indirect Coordination Mechanism

Every coordination mechanisms consist of a number of participating agents and at least one coordination medium[144]. Therefore, it has to be specified for each coordination medium which kind of interaction type is used. Since DCM and IDCM differ completely from each other, a separate model is provided for each of them. In this research, sign-based Stigmergy of food forging ants is used for designing the proposed RFIDMAMs with IDCM. In our design, pheromone is used as a message mediator. A pheromone is the information regarding communication and updating other agents that

is dropped by ant agent. For arriving IDCM in the new structure, agents need to lay down pheromones in the environment to let other agents interpret, and consider them during decision-making. The configuration model of our design is illustrated based on the class diagram in Fig 33.

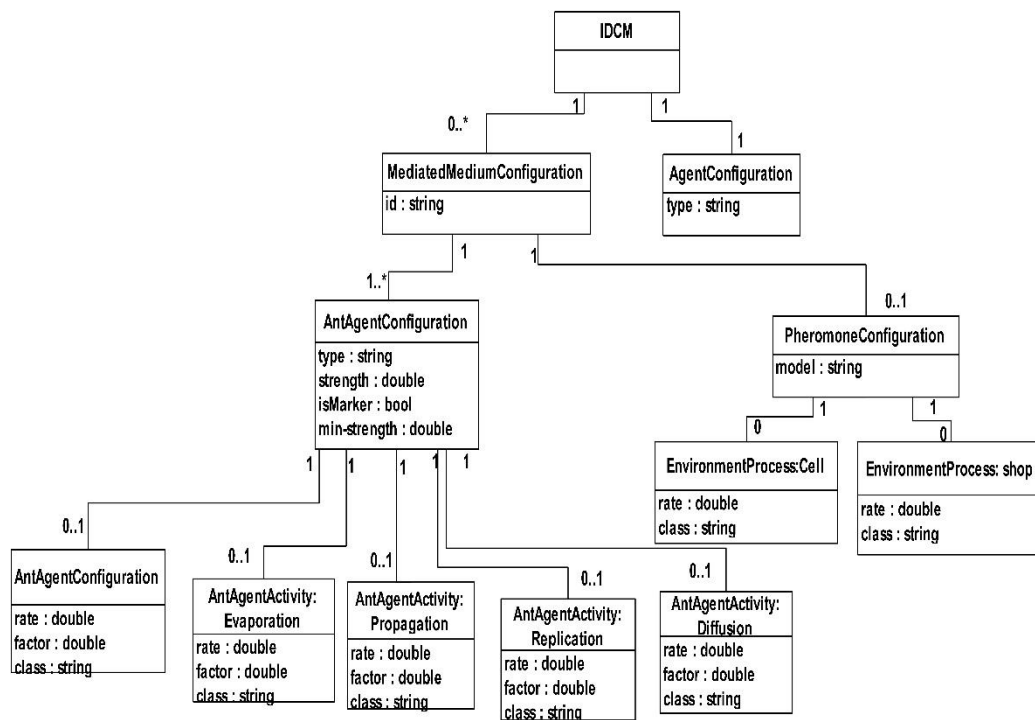

Figure 33. UML Class diagram of configuration of proposed mechanism

It consists of two main elements: Agent Configuration and Mediated Medium Configuration. The agent configuration references the agent types that use in the MASs. The mediated medium configuration is the most important one since consist of ant agent configuration and pheromone configuration. It is offers the possibility to configure the behavior of the agents to indirect interaction. Ant agent and pheromones are elements that can be produced, manipulated and deleted by agents and the environment. In addition pheromones can be perceived by agents. Different types of pheromone can be defined and used in order to realize coordination aims. In the RFIDMAMs, the SCA (information coming from RFID tag is attached to production),

MRA (information of the resource such as broke down), and SMA (new production information) create ant agents and spread pheromones. These ant agents travel virtually across the MAS to retrieve and disseminate information analogous to other agents via the service bus, which is like the ant colony system in the proposed design ant agents are created by station level and shop level. Figure 34 illustrates the proposed RFIDMAMs with ant agents.

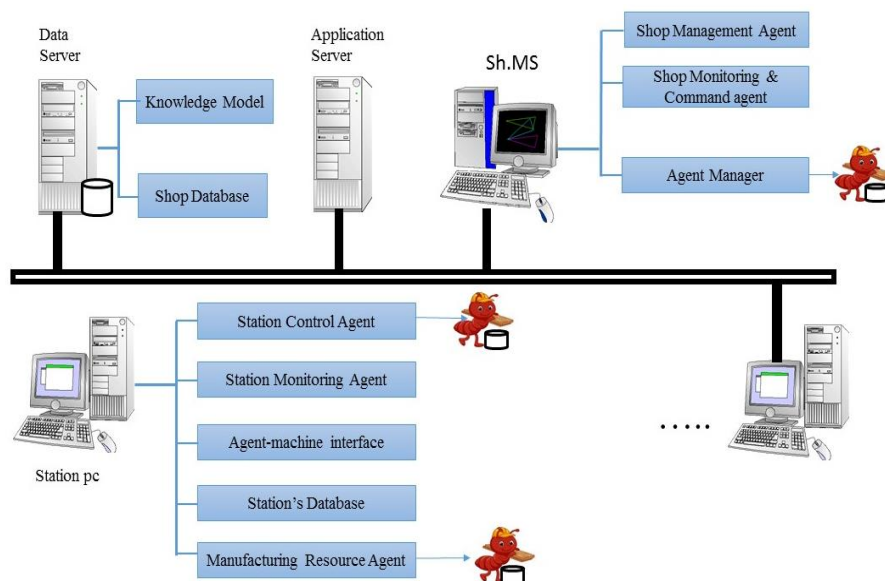

Figure 34. Proposed RFID MACS with IDCM

4.3.1 Ant agent for station level

Pheromone plays a significant role in this architecture for communication between agents. Ants carry pheromone, make collaboration between agents, and thus made decisions for agents based on the detected pheromone. In the proposed platform, pheromone from parts (product data) goes from RFID tags and is sent to the station level agents, which define new pheromone according to the capability list ant agent created for carrying this pheromone. In this design at the station level, SCA creates an ant agent and pheromone is defined properly by SCA. Doing so by SCA operation is as follows: when the part arrives at the RFID gate is detected and information exist on

the tag was attached to part is decode and send to the SCA. SCA according its capability list is make decision by considering arrive information. The decision is either accepted or rejected. If the decision is accepted, SCA creates the ant agent with pheromone (PD for its station) the ant agent moves inside the station level agent through the network and carries a pheromone, the pheromone is related data to producing the part that send it to MRA and SMA by ant agent. The sequence diagram of agent collaboration is illustrated in Fig 35.

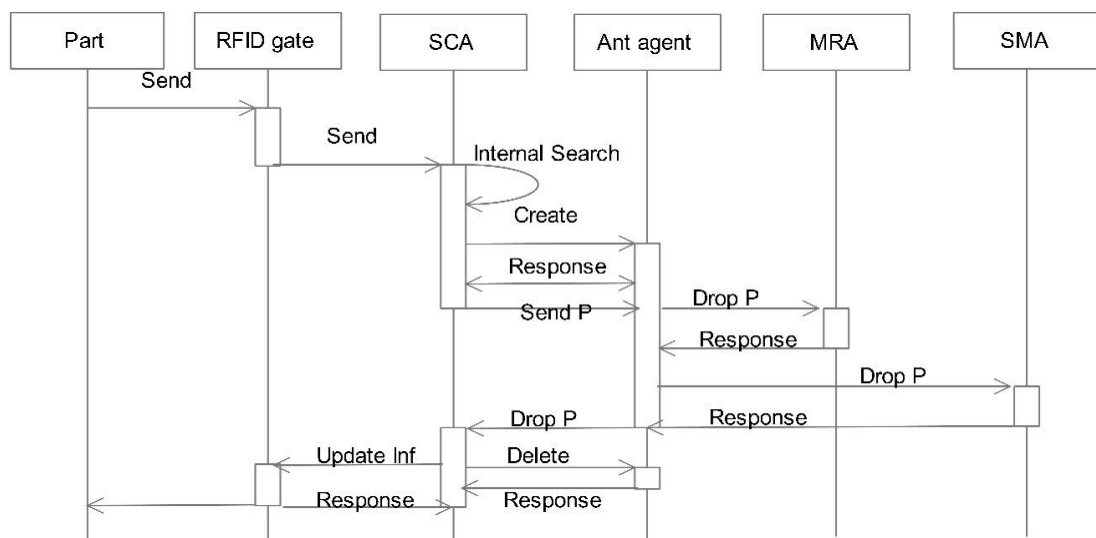

Figure 35: Sequence diagram of agent collaboration when decision of SCA is accepted

If the decision by SCA is not accepted to produce the part. Again SCA create ant agent with pheromone that same as product data that exist in the tag. The ant agent can move upstream or downstream through the network, carry a pheromone, and drop this information to the other SCA. The new SCA makes a decision if accepted updated pheromone and give it to the ant agent to carry through network. When ant agent arrived to the first SCA drop new pheromone. The first SCA gather this information and send to RFID gate for updating information on the tags this process also updated shop level agent information. Figure 36 illustrates the sequence diagram of the agent

collaboration. In this figure, the sequence diagram of the RFID gate for each station is shown.

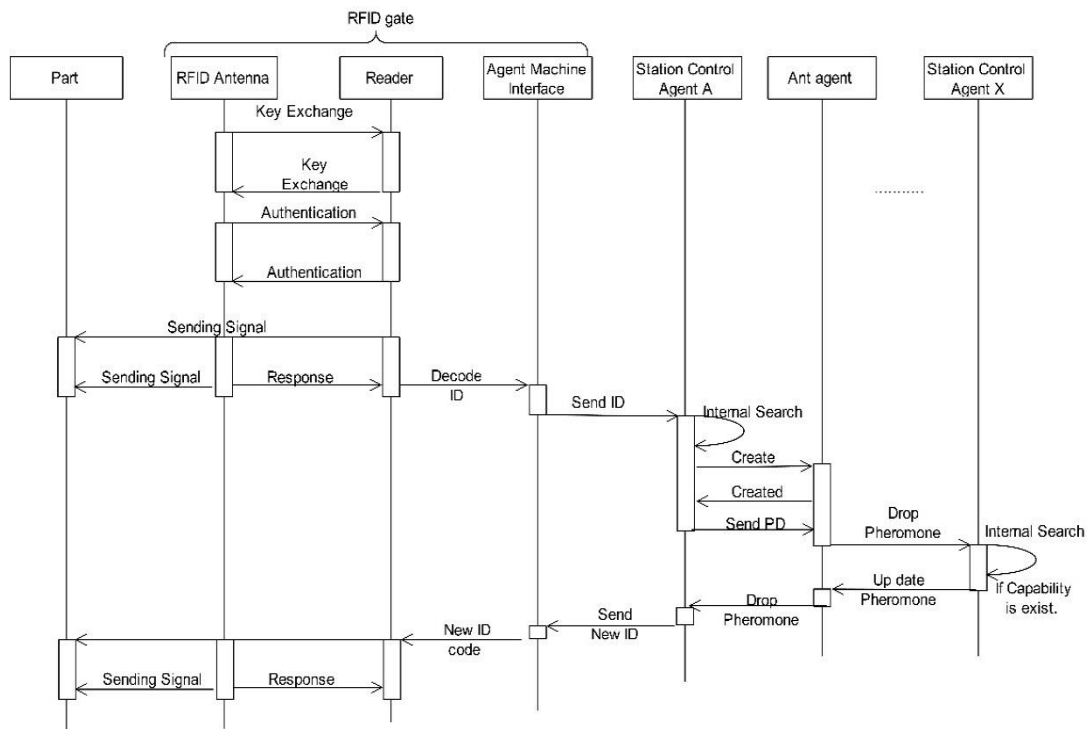

Figure 36: Sequence diagram of agent collaboration when decision of SCA is rejected

At the station level, MRA also creates an ant agent send local status (broke down or ideal) of the machine to the shop and station levels. The pheromone for the MRA is defined according to the status of the machine. The operation of defining pheromone for the ant agent created by MRA is as follows.

After one operation is processed by a machine, MRA creates the pheromone for the machine based on the current local status; if the current local status is "Ideal", the machine is implied to be in good working states, either "Busy" or "Free". But, if the current local status is "Broke down", the machine is in the "Down" state. This pheromone is carry by ant agent was created by MRA and uprate the capability lists of station level and shop level.

4.3.2 Ant agent for shop level

Shop level agents play a critical role in defining a new product or updating the capability lists of station agents regarding o the customer demand. For achieving the stigmergy at this level, SMA creates an ant agent with pheromone (such as new product data). This ant agent carries though the network and drop this capability list to other agents, this method is updated capability lists of agents. We have to mention that this communication is in both directions; i.e. station level can also communicate with the shop level via ant agent in the indirect communication manner. The XML schema configuration of ant agent for shop level is illustrated by Fig 37.

```
<Application>
  <CoordinationType="Indirect Interaction">
  <AgentConfiguration type="Ant"/>
  <MediatedMediumConfiguration Id="Pheromone 3D">
  <ElementConfiguration Type="Pheromone" isMarker="true"
  strength="10">
  <ElementActivityConfiguration type="Propagation">
  <factor>5</factor>
  </ElementActivityConfiguration>
  <ElementActivityConfiguration type="Evaporation">
  <factor>2</factor>
  </ElementActivityConfiguration>
  </ElementConfiguration>
  </MediatedMediumConfiguration>
  <Options>
  <IP>193.140.46.92</IP>
  <Port>25787</Port>
  <Options/>
  </Spaces>
  <...>
</Application>
```

Figure 37: XML schema configuration of ant agent for shop level

4.5 Summary

The complexity of manufacturing systems has been grown to unprecedented levels with a wide variety of products, procedures, and unexpected disturbances, which requires a more agile, robust, and reconfigurable control architecture. MASs play an important role in addressing this challenge by proposing a distributed control system with numerous autonomous and cooperative entities. This chapter aimed to provide an efficient MAS-based manufacturing control system by introducing IDCM inspired by

ant colony intelligent. The proposed IDCM was implemented in the RFIDMAMs. The major difference between this work and many other existing agent manufacturing control systems was that it integrated ACI to solve a communication problem not only for the existing MASs, but also for a resource breakdown.

Chapter 5

SIMULATION PLATFORM FOR IMPLEMENTING

MAS

5.1 Overview

Design and implementation of DCM for real industrial applications require risky, careful decisions to ensure that the manufacturing system will successfully satisfy the demands of an ever-changing market especially in the literature review is highlight that implementing MASs in real factory is very costly and time consumer. Therefore, this chapter focused on the proposed simulation platform for MASs by using Color Petri Net for visualization of hardware level in the shop floor. A case study based methodology is used for proposed simulation platform; flexible assembly line (FAL) factory is selected for this case study. The aim of this chapter implementing proposed RFIDMAMs in the flexible assemble line (FAL) based on proposed simulation platform. After verification of this simulation platform for RFIDMAMs in the FAL, we used same simulation platform for implementing proposed MASs in the chapter 3 and chapter 4.

5.2 Introduction

In the current era of agile manufacturing, lean manufacturing, intelligent manufacturing worldwide competitiveness and changing client prerequisites underscore the importance of effective planning, scheduling, and control systems[35]. However, as competition becomes increasingly violent and the need for differentiated and singular product introductions increase, the style of production remains an area in

which limited options exist. Producers must change their production systems to adapt to the changes occurring in manufacturing. Effective use of these new systems and machines requires effective scheduling and control systems because the control systems used have a direct influence on the productivity of manufacturing systems[14]. Effective scheduling and control architecture increase the flexibility and reconfiguration possibilities of manufacturing systems[88]. However, implementation of these kind of manufacturing system in the real factory is costly and risky, also existing simulation tools are insufficient in the simulation of these kind of system [112]. Because simulation tools just consider software level of the manufacturing system, and they are not consider hardware level and software level concurrently.

The developed simulation test platform is based on a hybrid agent (HA) and uses an existing RFIDMAMs architecture. The HA realizes simultaneous communication between the soft agents, along with communication with other hardware and low-level external software. Communication between the agents and simulation test platform is realized via the extensible markup language (XML). Color Petri Nets (CPN) Tools 4.0 is used as the shop-floor modeling software, as this tool has the ability to communicate with other software via XML. The basic feature of the simulation test platform developed in this study is that it supports the investigation of any control architecture when applied to a discrete manufacturing system.

5.3 Simulation Platform

Manufacturing system involves a significant number of different machines, which are associated with various robots and with material-handling and storage systems with different controllers. Analyzing this type of system in a real factory environment is infeasible, because of the long period of time that would be required for the

development of resources for each individual machine. It is also very difficult to reproduce the conditions of multiple experimental tests when attempting to compare alternative scheduling systems. One means of overcoming this problem is to use a simulation test platform that behaves like a real system. As regards the control of a real system, connection to a simulation test platform is indistinguishable from connection to a real system. An integrated simulation test system, which is referred to herein as the “simulation test platform,” was developed in this chapter, in order to evaluate the potential benefits of employing MAMs in manufacturing system. Further, we defined and integrated a new HA agent within our previously developed RFIDMAMs framework. The HA agent has the capability to communicate with other external agents, and can also send and receive data from other software using XML. Figure 38 illustrates the proposed RFIDMAMs architecture with added HA.

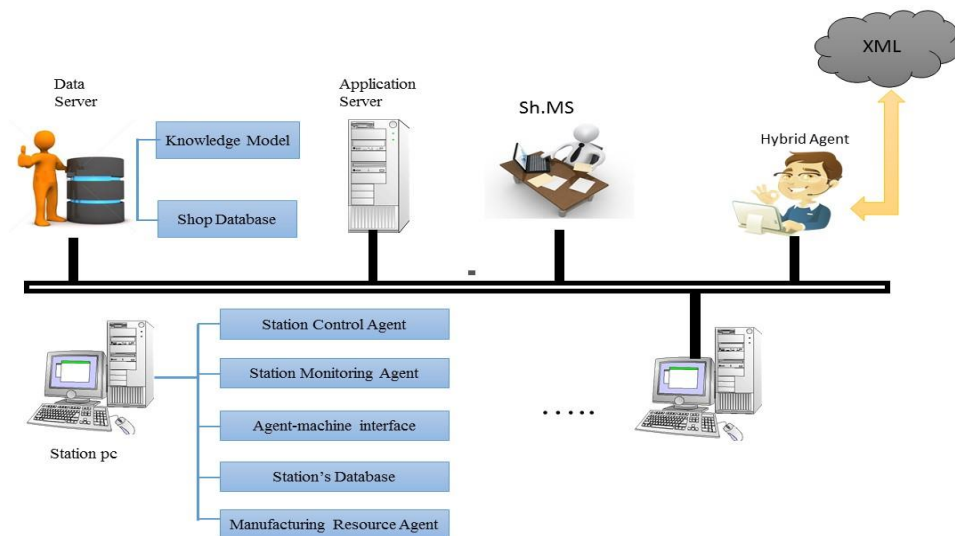

Figure 38: RFIDMAMs architecture with HA

The HA is a soft agent capable of moving throughout a network, interacting with foreign hosts, gathering information on behalf of the user, and returning to the user after performing an assigned task within the architecture. Additionally, the HA can

manage the tremendous amount of information that is available within the system networks. The characteristics of the HA include: (a) the ability to communicate with other agents in real-time; (b) the ability to understand the decisions made by the RFIDMAMs; and (c) the ability to communicate with other external software via XML. Figure 39 shows a sequence diagram illustrating the initiation of a new task in the system and the agent interactions. Examination of the manner in which new tasks are initiated by the user also demonstrates how decisions are made through the RFIDMAMs.

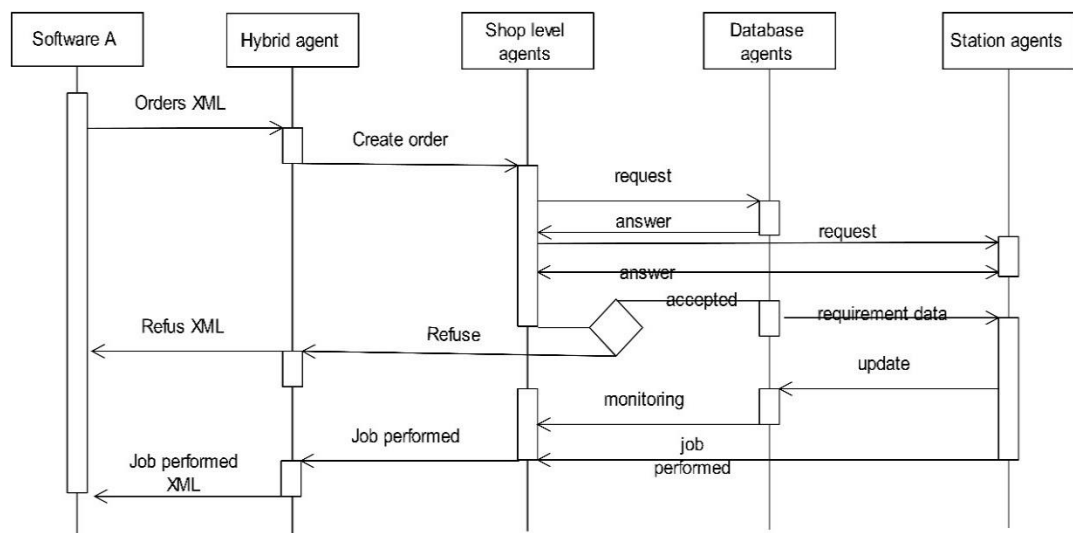

Figure 39: Sequence diagram for new task initiation in RFIDMAMs

As shown in Fig 39, a new task is sent to the HA via an XML file distributed through external software. The HA then communicates with the shop-level agents. As stated previously, the shop-level agent category comprises three agent types: the shop monitoring agents, shop monitoring and control agents, and agent management. A shop-level agent sends a request for new data to a database agent, who responds to this request. If the answer is positive, the shop-level agent sends a further request to the station agents checking for availability and the possibility of undertaking a new job. If

the answer to this request is positive, the shop-level agent accepts this job, sends a comment to the database agents, and the database agents send the requirement data to the station agents. The station agent performs its duty via communication between sub-agents.

The developed simulation test platform is illustrated in Fig 40. This platform contains two main modules:

1. Hardware simulation agent module: This belongs to the CPN model of the system and is used to analyze the FAL behavior.
2. RFIDMAMs with added HA module, which is related to the scheduling and control architecture of the system.

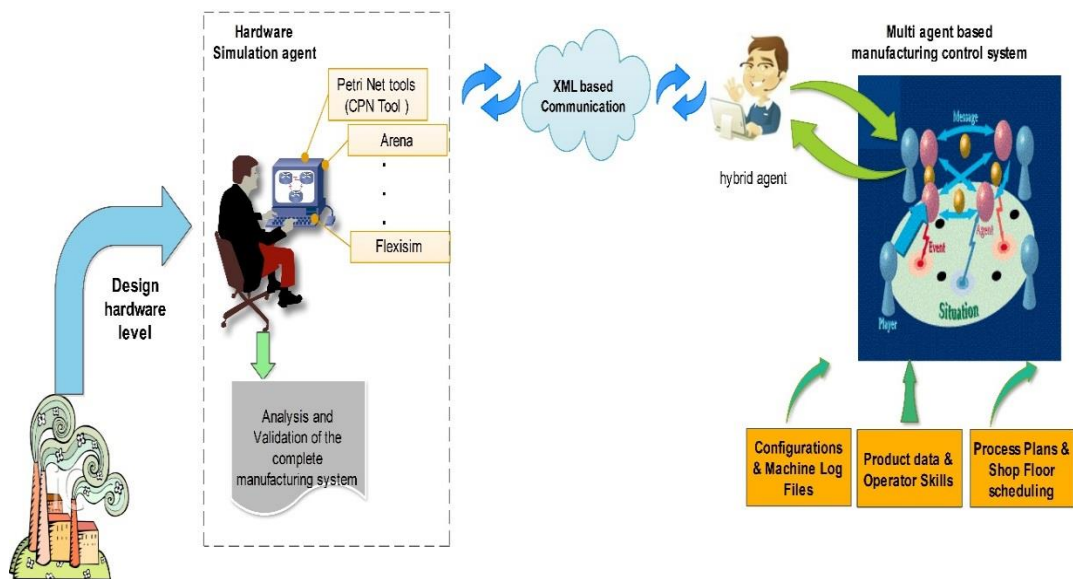

Figure 40: Simulation test platform architecture

The RFIDMAMs with added HA was employed to implementation. The hardware simulation characterized the physical actions that occur in the manufacturing environment. The communication model in the CPN tool was established, facilitating

real-time communication among the players. The XML code for integration of the hardware simulation and RFIDMAMs with added HA is shown in Table 6.

Table 6: XML code for description of agents, resources

MAS:	Agent:	Resources
<pre> <MAS NAME= "RFIDMAS"> <AGENTS-LIST> <AGENT NAME="HA"? > </AGENT> . <OBJECT-LIST> <OBJECTNAME="ASRS"> </OBJECT> . <STATES-LIST> . <ACTIONS-LIST> </MAS> </pre>	<pre> <AGENT NAME= "SMG"> <ATTRIBUTES> . </ATTRIBUTES> <CURRENT-STATE> . </CURRENT-STATE> <ACTIONS> . </ACTIONS> </AGENT> </pre>	<pre> <OBJECTS-LIST> <OBJECT NAME="ASRA"> <ATTRIBUTES> . </ATTRIBUTES> <CURRENT-STATE> . </CURRENT-STATE> </OBJECT> </OBJECTS-LIST> </pre>

A system incorporating each agent thread that runs and interacts with the components of the simulation, with the aid of a communication module was developed in Java; this is the multi-agent control part of the system. The RFIDMAMs with added HA was developed in the Java agent development (JADE) framework.

Registration services, the sending/receiving of ACL messages, remote management, and the addition of features that characterize the precise behavior of each agent class are a number of basic agent-based software system functionalities that are delivered by the JADE platform. To permit the implementation of numerous actions in parallel, every agent in the system uses multi-threaded programming based on the JADE framework. Operation status, machinery failure, order influx, order type, and other resource information are all provided in messages from the simulation part to the multi-agent control. Actions are taken against any interruptions that occur within the simulation part, which is responsible for sending the control signals to the simulation component for the implementation of defined schedules. To promote seamless transfer

between the two processes in a multithreaded program construction, which transmits status update messages from the simulation along with control messages within the control framework, a custom, but widely recyclable, modeling building block was designed.

5.4 Case Study

The simulation test platform was employed for the case of a medium-sized FAL in a gas-oven factory, in order to demonstrate the effects of RFIDMAMs on the system performance. The performance extracted from the RFIDMAMs was compared with that of a conventional production control system in the same factory. A medium-sized gas-oven factory was considered, where oven parts for a variety of products are assembled. The main products output by this factory are ovens for home use, with different sizes and features. The layout of the factory FAL is illustrated in Fig 41.

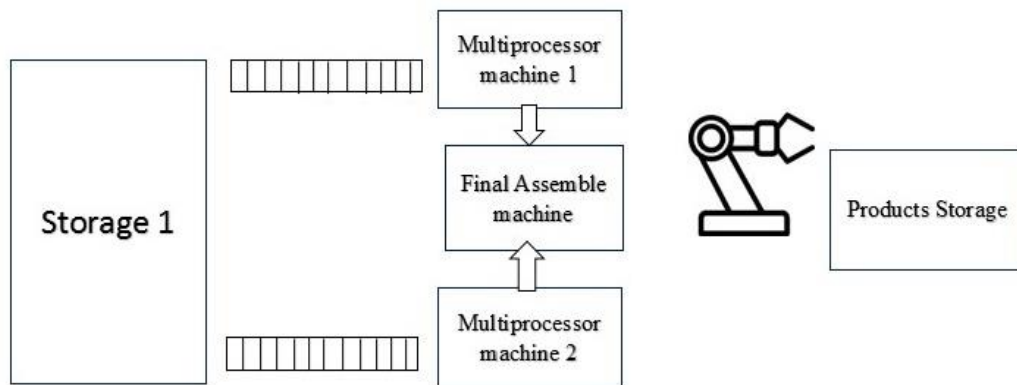

Figure 41: Flexible assembly system layout

The shop contains a final assembly machine (FAM), a SCORBOTER 10 robot, two multiprocessor machines (M_1 and M_2), two storage centers, and two conveyors for transporting parts from storage to M_1 and M_2 . PN was used to model the FAL.

PN is a mathematical and graphical language for the design, specification, simulation, and verification of discrete event systems[90]. CPN, which is a backward-compatible extension of PN, can overcome the weaknesses of PN as regards description of complex systems. A CPN model, like a PN model, consists of four components: place, transition, direction, and token. A CPN model can achieve a compact representation of a system by attaching a data value, i.e., a color, to each token. CPN, and especially hierarchical CPN, has primarily been used to model and analyze large systems, such as automated manufacturing systems. In this case study, a top-down approach was used for the modeling: first, the CPN model of the stations was extracted; second, using place negotiation, all of the CPN model stations were integrated as shops; third, the negotiation model of the system was extracted; and finally, the CPN model of the RFID gates was developed. Through the place negotiation, the CPN model of the system was integrated with the RFIDMAMs using the HA.

5.4.1 Station and shop level CPN models in case study

CPN models were created for all stations by taking the capabilities of the real system into consideration. Figure 42 shows the CPN model of a multi-process machine and the robot loading part. To model the stations and shops of the FAL, process-oriented PNs (POPNS) are used[91]. In this method, operation places are used to describe the operation sequences of every part to be processed in the system, and resource places are used to describe the resource requirements for all the operations. To model the FAL using POPN, the following interpretations of places, transitions, and tokens are employed, (a) A place (circle) represents a resource or job-order status, or an operation, (b) If a place represents a resource status, the presence (absence) of a token (dot) indicates that the resource is available (unavailable), (c) A transition (rectangle) represents either the start or completion of an event or operation process. For this

Modeling the FAL described in the case study using a dedicated CPN results in a concise model. The system model describes the resources and the properties that are independent of the work plans. Figure 43 shows the top layer of the hierarchical model of the assembly line structure. Each of the so-called substitution transitions is refined by a subpage that describes the behavior of a machine or a conveyor in more detail. In this model, the places labeled N realize station integrations. In addition, these places act as data communication gates (B-to-B using XML codes) with RFIDMAMs.

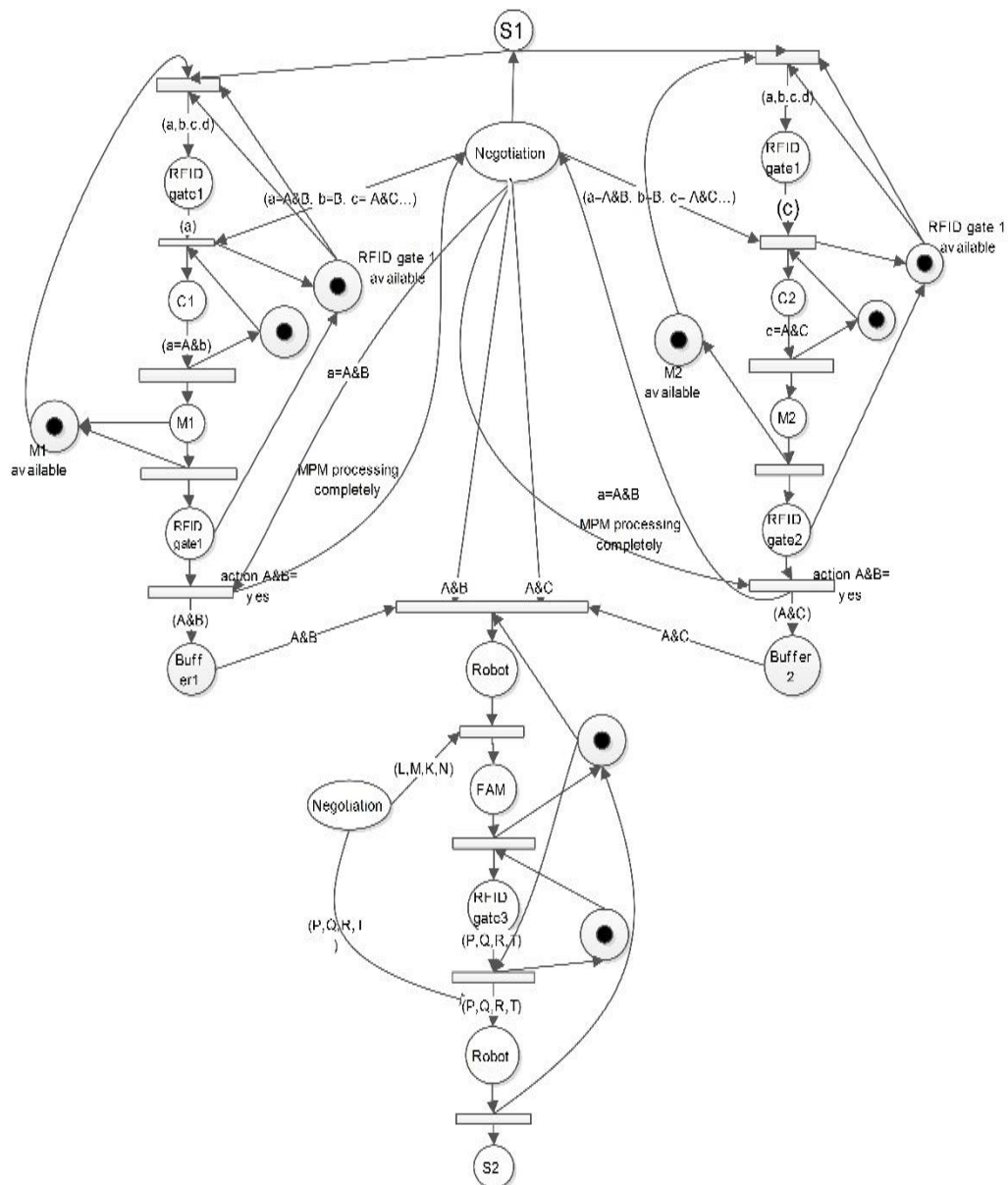

Figure 43: System level model

5.4.2 Sensor level

RFID technology is used to track and trace WIPs instead of traditional sensor technology, because of the unique capabilities of this technology. Figure 44 shows the sensor-level CPN flow control module of the RFID device. Two tasks performed by RFID technology are reading and writing commands on RFID tags.

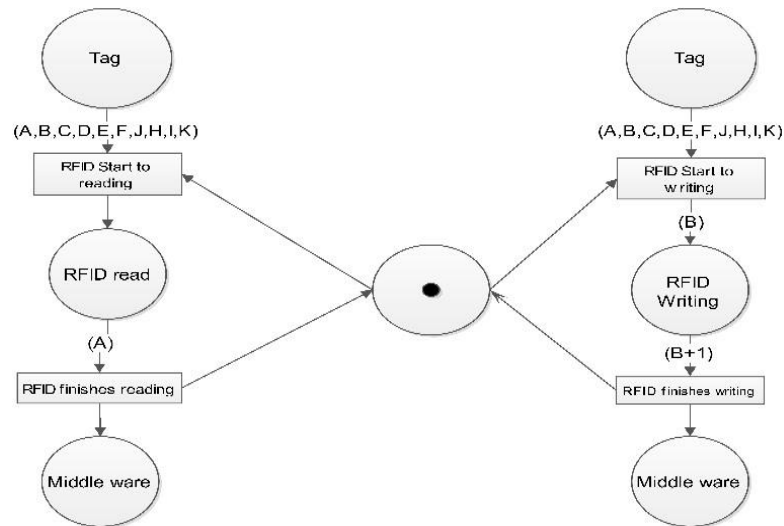

Figure 44: Sensor level model

5.4.3 Agent negotiations in FAL

To construct negotiation protocols for the agents involved in the FAL, we first considered one station control agent and the number of resource agents competing to execute the order. In this study, it is assumed that the set of candidate resource agents is never empty for all the orders entering the system. It is also assumed that any candidate resource agent can propose a time window for the resource for order execution. Note that the objective of the study is to propose a negotiation protocol such that a negotiation failure never occurs. Taking these negotiation requirements into account, a negotiation model for the system control agents was proposed (see Fig 45).

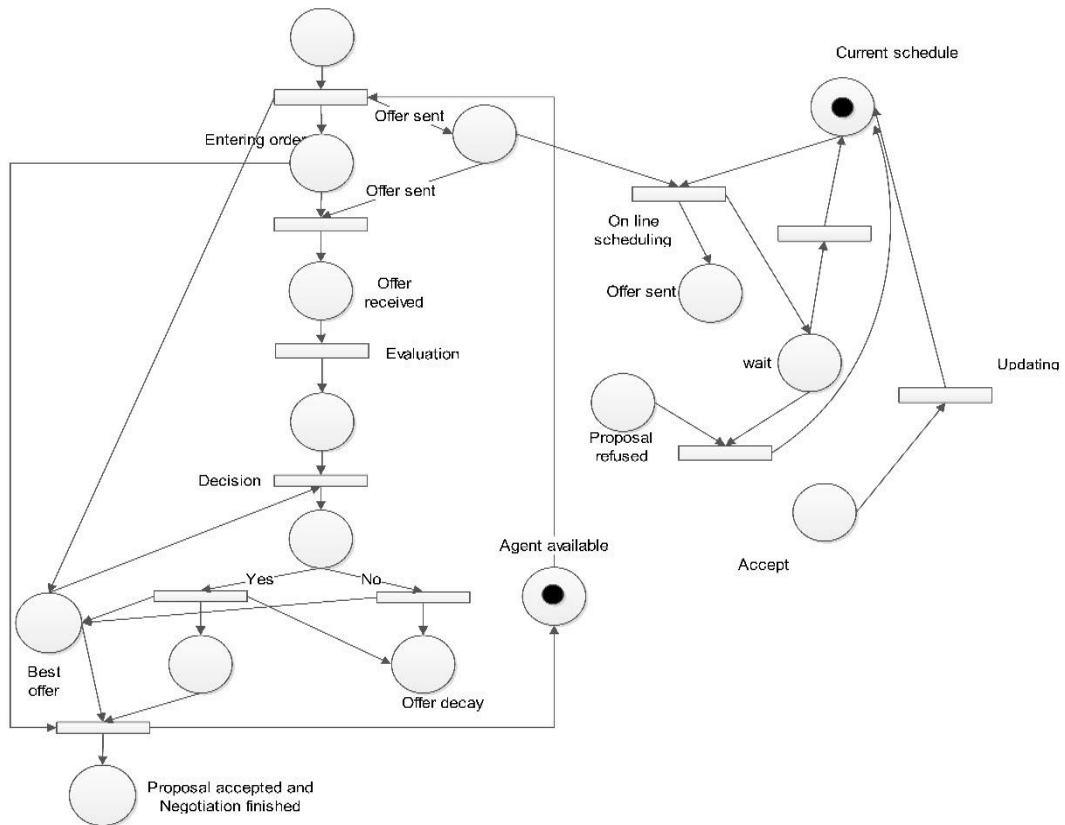

Figure 45: Agent negotiations

4.5 Summary

In this chapter simulation platform for agent, based manufacturing system is proposed and explained in the details by case study. The proposed simulation test platform architecture consisted of two modules, namely the hardware simulation agent and the MASs with added HA. CPN was used to model the hardware simulation module, while all shop-related information was exchanged by the MASs platform through the HA. A simulation performance assessment was performed in a real case study in order to investigate the effectiveness of the RFIDMAMs approach in comparison with a conventional control platform. The merits and benefits of the developed simulation test platform in comparison to existing tools are as follows:

- This platform is a generic real-time simulation test platform that can be applied to not only FALs, but also any flexible manufacturing system (FMS), in order to examine the efficacy of upgrading a conventional centralized control system to the newly emerged RFIDMAMs. The test platform tool can be used to validate the system performance improvements prior to any expensive investments.
- The simulation test platform is flexible and modular. The modular architecture allows any other control approaches (e.g., holonic manufacturing) to be integrated.

Chapter 6

RESULT AND DISCUSSION

6.1 Overview

In this chapter we highlighted the results of each chapters and discuss about of these results, the proposes agent based agile manufacturing system by considering different case study are implemented on simulation platform and real scenarios for each case study is defined at this chapter. Simulation platform for each case study is developed based on propose simulation platform at chapter 5 and real scenarios are defined for each case study. The analysis takes into account the comparisons of the overall performances of the proposed system models using the MASs scheduling and conventional scheduling approaches. The result of simulation indicates that the proposed all MASs could increase the uptime productivity.

6.2 Performance indicators

Performance indicators can be classified as qualitative and quantitative. The quantitative indicators considered are based on various production performance measures, such as the lead time and throughput. The vital quantitative indicators that must be considered in lean production are the average buffer levels of the system. In the interests of simplicity, no buffer was considered in the case study; therefore, this indicator is neglected here. Another variable of interest in this study is the system output variability, which can be measured from the coefficient of variation (CV) of the production output per unit time [35]. The CV is an indicator that represents the ratio of the standard deviation to the mean, and it is a useful statistic for comparing the

degree of variation between the conventional system performance and the new system, even if the means are drastically different from each other. The qualitative indicators are of a more subjective nature and reflect properties of the manufacturing control solution, such as agility and flexibility that cannot be directly determined from the production data. In the simulation tests, was evaluated by analyzing the following performance indicators:

- Manufacturing lead-time: The total time required to manufacture an item, including the order-preparation, queue, setup, process, move, inspection, and put-away times.
- Throughput: An indicator of the productivity of a manufacturing system, defined here as the number of items produced per unit time.
- Resource utilization: The percentage of processing time during a time interval.

6.3 Result of UPVC Company

The simulation test platform for evaluating the proposed agent based agile manufacturing is developed and agent based software is linked by hardware simulation. Therefore, two scenarios for evaluating the proposed dynamic scheduling system based on agent technology for agile manufacturing in the MFL (uPVC) are used. The first scenario evaluates the response of the system in terms of the dynamic customer demands and the second scenario focuses on the quantitative indicators based on various production performance measures. To compare the current state and the future state, the approach introduced in is used to quantify the degree of improvements. The number of units produced is considered using the number of squares. Generally,

the performance of the manufacturing systems is measured in units/hour. As per this convention, the performance in the case an MFL should be measured in terms of the number of windows/doors produced per hour or shift. However, in this case, the size and complexity of windows/doors differ considerably. Hence, this unit of measurement may not fairly reflect the performance of the MFL. To overcome this problem and to establish a normalized production rate and productivity, the number of squares is used. Table 7 presents the impact factor for calculating number of squares of the products. As examples, a door type B with 1.8 m² size is considered as 2.25 m² and a window type A with 3.4 m² size is considered as 3.91 m².

Table 7: Impact factor for calculating number of squares

Product	Impact factor
Window type A,B,C,D 0 _{m2} <Size<2.2 _{m2}	1
Door type A, B 0 _{m2} <Size<2 _{m2}	1.2
Door type C 0 _{m2} <Size<2 _{m2}	1.3
Window type A Size>2.2 _{m2}	1.15
Window type B Size>2.2 _{m2}	1.25
Window type C,D Size>2.2 _{m2}	1.45
Door type A Size>2.2 _{m2}	1.35
Door type B Size>2.2 _{m2}	1.45
Door type C Size>2.2 _{m2}	1.65

In the simulation, the setup time was not considered, and it was assumed that a failure of negotiation would never occur. A robot and a conveyor were used for transportation, and the orders were queued in the order of arrival. Each transport action required 1 min, and the average processing time was equal to 20 min. The tests considered the

data corresponding to the month of July. The adopted unit of time was 1/50th of a minute as in the standard time data. Using the Welch method, a warm-up period of 20 hours was used to fill the machine queues and obtain steady state results.

In the first scenario, the company categorized the customers into two groups. Group one includes the customers who order a high volume of products with long due dates, whereas group two includes the customers who order a small list of products with short due dates. The total daily production capacity of the company is 22300 squares. The competitive strategy of the company for the month of July is providing at least 10000 squares for group one of the customers. This article focuses on providing decisions for the second group of customers, which deals with the dynamic demands. For sketching this, the data related to July is used and the results of both the current and newly developed systems are compared. Normally every day, 5-10 requests with different due dates are received from clients. The company uses the due dates and the number of squares for deciding whether to accept or reject the requests. Table 8 lists the customer demands corresponding to the month of July and the number of squares.

Table 8: Customer demand for July in YBG Company

Day	Window	Door	Window A,B,C,D 0<Size<2.2	Window A Size>2.2	Window B Size>2.2	Window C,D Size>2.2	Door A, B 0<Size<2.2	Door C 0<Size<2.2	Door A, Size>2.2	Door B, Size>2.2	Door C, Size>2.2	Number of Squares	
1	220	260	100	60		60	50	50	60	50	50	617.00	
2	130	20	50	40		40		20				180.00	
3	170	30			100	70			30			267.00	
4	0	0										0.00	
5	400	150	200		200		50	50	50			642.50	
6	0	0										0.00	
7	220	40	220				40					268.00	
8	230	150		80	50	100				50	100	537.00	
9	220	130	100	120			130					394.00	
10	430	70	230	200						70		561.50	
11	0	0										0.00	
12	560	0	100	240	220							651.00	
13	480	50		120	100	260	50					700.00	
14	440	160	150	150		140			160			741.50	
15	460	40	60	200	200		40					588.00	
16	290	280	20	20	50	200	150	130				744.50	
17	0	0										0.00	
18	470	200	10	100	100	260	50	150				882.00	
19	0	730					500	230				899.00	
20	70	320	70				320					454.00	
21	140	440			100	40			400	40		781.00	
22	150	350	50	100				100		200	50	667.50	
23	170	400	70		100			100	100	100	100	770.00	
24	0	0										0.00	
25	0	340						100	140	100		464.00	
26	0	340						140	100	100		462.00	
27	140	160	40	100			100	60				353.00	
28	0	410					410					492.00	
29	140	440	80	10		50	440					692.00	
30	70	43	70					100	100	100	130	694.50	
31	0	0										0.00	
												Total	14503.00

In this work, the comparison between the scheduling approaches considered number of squares a batch of orders for July, aiming at reducing the makespan (C_{max}). After running the test platform for the proposed MAS by considering the warm-up time, the

dynamic demand was sent to the scheduling system. Table 9 summarizes the total accepted number of squares for this month and makespan achieved for each scheduling system. We have to mention that both the systems producing windows have priority to produce doors. Therefore, the system tries to finish the windows before the door. It starts producing doors after finishing windows.

Table 9: Result of simulation and conventional system for accepted parts

Performance measures	Conventional DSS	Multi agent based DSS
Total acceptance rate for dynamic demand (%)	70.3%	79.8%
Makespan C_{max} (min)	204.53	182.16

Based on the experimental results of first scenario, the best C_{max} founded by the proposed DSs. The rate of acceptance of the multi-agent-based DSS is equal to 0.798, and the rate of acceptance of the conventional system in July is equal to 0.703. This rate shows that more products can be produced by using the MAS than the conventional system because the MAS can reschedule in the dynamic model.

The second scenario focuses on the quantitative indicators namely lead-time, throughput, and resource utilization for the case of internal disturbances. For evaluating the performance of the system, two sub-scenarios are considered: a well-functioning system with no disturbances and a 20% probability of a failure occurring in the profile-welding machine. The probability distribution for the failure time was regarded as an exponential distribution with a rate of 25. A Weibull distribution with a total availability of 85% was used for the repair time with the mean repair time as 60 min.

The experience gained from the simulation debugging and testing allowed us to draw some conclusions concerning the operation of the proposed MAS in the MFL. The system was found to function robustly in accordance with the specifications for both the normal operation and in the presence of disturbances. Furthermore, the re-configurability of the system was demonstrated by its accurate reactions to the introduction, removal, and modification of manufacturing components. The average values of standard deviations (SD) and the coefficient of variation (CV) for each subtest scenarios are presented in Table 10–12.

Table 10: Summary of lead-time experiment results

Lead time						
Scenario	Type	SD	Mean	LCL 95%	UCL 95%	CV%
2.1	Conventional	0.85	10.32	9.45	11.19	8.2
	MAS	0.56	9.45	8.64	10.26	5.9
2.2	Conventional	3.457	17.26	15.894	18.626	20.02
	MAS	2.24	13.756	12.49	15.022	16.2

Table 11: Summary of throughput experiment results

Throughput						
Scenario	Type	SD	Mean	LCL 95%	UCL 95%	CV%
2.1	Conventional	57.4	1211	1191	1231	4.73
	MAS	48.48	1259	1251	1267	3.85
2.2	Conventional	109.7	803	711	895	13.66
	MAS	89.6	980	908	1052	9.14

Table 12: Summary of resource utilization experiment results

Resource utilization						
Scenario	Type	SD	Mean	LCL 95%	UCL 95%	CV%
2.1	Conventional	0.039	0.871	0.801	0.941	4.47
	MAS	0.031	0.962	0.92	1.004	3.22
2.2	Conventional	0.054	0.69	0.774	0.848	7.82
	MAS	0.044	0.921	0.895	0.974	4.77

The first sub-scenario of scenario two is the system operates predictably and has no disturbance. In this scenario, the proposed MAS presents smaller values of manufacturing lead-time (9.45), higher values of throughput (1259), and higher values of resource utilization (0.962) than the conventional system (10.32, 1211, and 0.871, respectively). The better performance of those systems is a result of the cooperation of the autonomous entities.

The second sub-scenario of scenario two is the experimental test considering the occurrence of unexpected disturbances in the welding machine. It is obvious that the performance indicators degrade in the presence of disturbances. From the analysis of lead-time, throughput, and resource utilization, it can be verified that the proposed MAS offers a better performance than the conventional system.

6.4 Result of Flexible Assemble Line Company

Experiments were conducted by considering two different scenarios: (a) no disturbances and a well-functioning system, and (b) a 15% probability of failure occurring in M_1 . The probability distribution for the failure time was regarded as an exponential distribution with a rate of 25. A Weibull distribution with a total availability of 85% was used for the repair time, with the mean repair time being taken as 60 min. No setup time was considered, and it was assumed that negotiation failure would never occur. The transporting operations were performed by robot and conveyor, and orders were queued in order of arrival. Each transport action required 0.78 min. For each part, the processing time at M_1 and M_2 was 4.5 min, and the FAM processing time for the final product was 2.8 min. Each individual book of orders comprised the production of four components: a body, two handles, and a cover. For this purpose, the body was first placed in either M_1 or M_2 , where handles were

assembled. Then, the body was transferred to the FAM, the cover was sent to the sub-assembly, and the final product was transferred to storage by a robot. The tests considered 10,000 working minutes. The adopted time unit was 1/100th of a minute, as in the standard time data provided. Using the Welch method, a warm-up period of 1500 min was used to fill the machine queues and to obtain steady-state results. Overall, 25 replication runs were performed for each model and for each test case. The experience gained from the simulation debugging and testing allowed us to draw some conclusions concerning the operation of the RFIDMAMs in the FAL. The system was found to function robustly and in accordance with specifications for both normal operations and in the presence of disturbances. Furthermore, the re-configurability of the system was demonstrated by its accurate reactions to the introduction, removal, and modification of manufacturing components. In particular, it was shown that, when a resource control agent broke down or was removed from the system, other agents continued to find alternative solutions for executing the production plan. The average values, standard deviations (SD) and coefficient of variation (CV) for each test case are presented in Tables 13–15.

Table 13: Summary of lead-time experiment results.

Lead Time						
Scenario	Type	Mean	SD	LCL95%	UCL95%	CV%
1	Conventional system	8.98	0.43	8.529	9.431	4.78
	RFIDMAMs	8.08	0.297	7.671	8.489	3.67
2	Conventional system	16.363	3.267	15.649	17.078	19.96
	RFIDMAMs	12.756	1.788	12.192	13.32	14.01

Table 14: Summary of throughput experiment results.

Throughput						
Scenario	Type	Mean	SD	LCL95%	UCL95%	CV%
1	Conventional system	1006	47.5	986	1026	4.72
	RFIDMAMs	1054	44.58	1008	1100	4.22
2	Conventional system	598	104.86	506	690	17.53
	RFIDMAMs	775	88.64	704	846	11.43

Table 15: Summary of resource-utilization experiment results

Resource utilization						
Scenario	Type	Mean	SD	LCL95%	UCL95%	CV%
1	Conventional system	0.945	0.032	0.901	0.989	3.38
	RFIDMAMs	0.98	0.029	0.93	1.03	2.95
2	Conventional system	0.81	0.078	0.774	0.848	9.62
	RFIDMAMs	0.97	0.039	0.925	1.015	4.02

Analysis of the SD of the utilization of all the resources indicates whether the manufacturing load is evenly distributed by all of the resources or concentrated in a few points. A high value for this parameter may indicate the existence of overloaded resources, and the need to re-allocate some of the load to other resources. Figure shows the results for the stable scenario, i.e., no unexpected disturbances, and also for a manufacturing scenario incorporating disturbances. In the stable scenario, the RFIDMAMs yielded smaller values for the manufacturing lead-time and higher values for the throughput, in comparison to those obtained using a conventional control system. The superior performance of the proposed system is the result of cooperation between autonomous entities, i.e., the employment of an agent manager that elaborates upon optimized production plans.

The first conclusion drawn from these simulation results is that the values of all the performance indicators decreased in the presence of disturbances. An analysis of the lead times and throughputs confirmed that the RFIDMAMs nonetheless yielded

superior performance than the centralized control system. Disturbances increase the entropy and unpredictability of a manufacturing control system. However, RFIDMAMs implementation enhances the system performance by improving the system's ability to respond to disturbances, as illustrated by the smaller manufacturing lead-time values and higher throughput values, compared to the conventional scheduling control approach. The difference in performance between these two types of systems increases as the number and frequency of breakdowns increase. The results indicate that the proposed system can achieve good productivity even with increased resource interruptions, and that it can respond to resource breakdowns effectively. Analysis of the results confirms that use of the proposed RFIDMAMs results in superior resource utilization to that provided by the conventional approach in both stable and unstable scenarios.

6.5 Result of Ant agent based MAS

The simulation test platform for evaluating the proposed agent based agile manufacturing is developed and agent based software is linked by hardware simulation. In chapter 4 FAM that explain on the chapter 5 is used as case study for evolution of the proposed self-organization system in the agent based agile manufacturing system. Therefor the experiments were conducted by considering two different scenarios: the first one, no disturbances and well-functioning system and, the second one, the 15% probability of failure occurring at M_1 . The probability for the failure time was regarded as an exponential distribution with the rate of 25. A Weibull distribution with the total availability of 85% was used for the repair time with the mean repair time being taken as 60 min. No setup time was considered and it was assumed that negotiation failure would never occur. Robot and conveyor performed the transporting operations and the orders were queued in the order of arrival. Each

transport action required 0.78 min. For each part, the processing time at M_1 and M_2 was 4.5 min and the FAM processing time for the final product was 2.8 min. Each individual book of the orders comprised the production of four components: a body, two handles, and a cover. For this purpose, the body was first placed at either M_1 or M_2 , where the handles were assembled. Then, the body was transferred to the FAM, the cover was sent to the sub-assembly, and the final product was transferred to storage by a robot. The tests considered 10,000 working minutes. The adopted time unit was 1/100th of a minute, as provided in the standard time data. Using the Welch method [146], a warm-up period of 1500 min was used to fill the machine queues and to obtain steady-state results. Overall, 25 replication runs were performed for each model and test case.

The experience gained from the simulation running allowed us to draw conclusions concerning the operation of the RFIDMAMs based on IDCM in the FAL. The system was found to function robustly and in accordance with the specifications for both normal operations and disturbance presence. Three indicators were used for analyzing the system performance: manufacturing lead-time, throughput, and resource utilization. The average values, standard deviations (SD), and coefficient of variation (CV) for each indicator were calculated to make a comparison between the simulation results for RFIDMAMs + ant agent and RFIDMAMs + CNP. Summaries of each test case are presented in Tables 16-18.

Table 16: Summary of lead-time experiment results

Lead Time						
Scenario	Type	Mean	SD	LCL95%	UCL95%	CV%
1	Conventional system	8.98	0.43	8.529	9.431	4.78
	RFIDMAMs+CNP	8.08	0.297	7.671	8.489	3.67
	RFIDMAMs+ant agent	8.07	0.294	7.662	8.481	3.64
2	Conventional system	16.363	3.267	15.649	17.078	19.96
	RFIDMAMs+CNP	12.756	1.788	12.192	13.32	14.01
	RFIDMAMs+ant agent	11.17	1.51	10.461	11.88	13.51

Table 17: Summary of throughput experiment results

Throughput						
Scenario	Type	Mean	SD	LCL95%	UCL 95%	CV%
1	Conventional system	1006	47.5	986	1026	4.72
	RFIDMAMs+CNP	1054	44.58	1008	1100	4.22
	RFIDMAMs+ant agent	1056	44.12	1009	1103	4.17
2	Conventional system	598	104.86	506	690	17.53
	RFIDMAMs+CNP	775	88.64	704	846	11.43
	RFIDMAMs+ant agent	784	82.42	721	847	10.51

Table 18: Summary of resource-utilization experiment results

Resource Utilization						
Scenario	Type	Mean	SD	LCL95%	UCL 95%	CV%
1	Conventional system	0.945	0.032	0.901	0.989	3.38
	RFIDMAMs+CNP	0.98	0.029	0.93	1.03	2.95
	RFIDMAMs+ant agent	0.98	0.028	0.92	1.01	2.85
2	Conventional system	0.81	0.078	0.774	0.848	9.62
	RFIDMAMs+CNP	0.97	0.039	0.925	1.015	4.02
	RFIDMAMs+ant agent	0.98	0.032	0.957	1.008	3.25

The first conclusion drawn from these simulation results was that the values of all the indicators decreased in the presence of disturbances. In the first scenario, no disturbance the system operates predictably. In this scenario, the proposed

RFIDMAMs + ant agent presented smaller values of manufacturing lead-time (8.07) and higher values of throughput (1056) and higher values of resource utilization (0.98) than the RFIDMAMs +CNP and conventional system. The better performance of RFIDMAMs + ant agent was the result of IDCM in MASs.

The second scenario with unexpected disturbance in the M_1 . It is obviously clear that the results were the degradation of all the performance indicators in the presence of disturbances. From the analysis of lead-time, throughput, and resource utilization, it can be verified that RFIDMAMs +ant agent offered better performance than RFIDMAMs +CNP. In both scenarios, it is evident that the conventional system or central control system had weaker performance than MASs, especially from RFIDMAMs + ant agent. Figure 46 illustrates the mean value of these three indicated in both scenario.

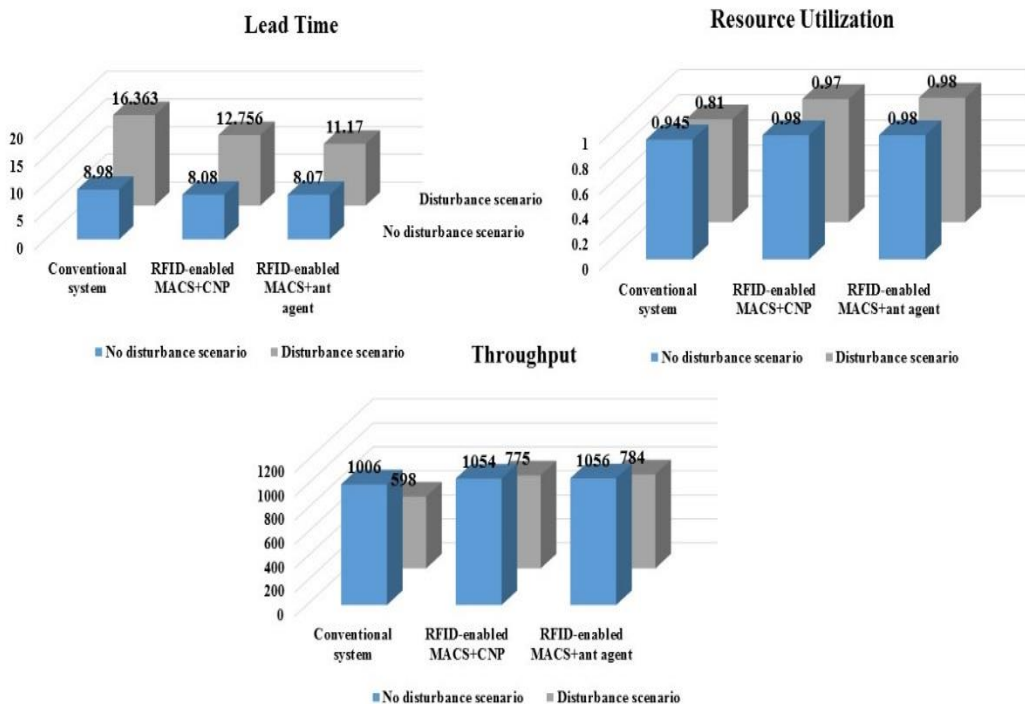

Figure 46: Summary of the experimental results

The experience gained during prototype implementation, debugging, and testing allows us to draw some conclusions about the operation of the RFIDMAM in FMS. It was verified that the system works as specified in both normal operation and in the presence of disturbances, thus validating the robustness of the developed system. Additionally, the re-configurability of the developed system was proven from its accurate reactions to the introduction, removal, and modification of manufacturing components. Specially, it was shown that when a “resource control agent” breaks down or leaves the system, other agents continue to find alternative solutions for executing the production plan.

Chapter 7

CONCLUSION

At the beginning of 21st century, the manufacturing companies have begun facing with a dynamic environment where economical, technological and customer trends changes rapidly, requiring the increase of flexibility, agility and re-configurability to react to unexpected disturbances, maintaining the productivity and quality. For this reason, the traditional manufacturing system have adapted intelligent production control and scheduling methods, re-configurable manufacturing hardware and software and flexible organizational structures, which allow the people's integration to the manufacturing system in order to cope with the agility requirements of the century.

The experience has shown that the adaption of the agility has been possible by careful design of the manufacturing systems, by considering the flexibility and re-configurability requirements of agile manufacturing. The major parts of agile manufacturing system is control and scheduling system. control flexibility and dynamic scheduling system are highly improved the performance of agile manufacturing system. But implementation and design such systems requires expensive and huge time consuming efforts to develop and test whether the newly designed manufacturing system would satisfy the requirements of the company and match the current operations in the existing manufacturing plant, so that it cloud be implemented without disrupting the operations.

In this thesis, we proposed a novel agent based agile manufacturing system by covering existing lacks. The proposed agent based firstly design and developed for overcome of the all exist disturbance in the real system, after that with help of stigmergy mechanism on the ant colony, the proposed system is improved shifting to indirect communication between agents, and the proposed mechanism is implemented in the reference. At last for implementing proposes system a simulation platform is developed based on the CPN tool.

The novel simulation platform is suggested for implementation of all types of the manufacturing system for reducing cost of implementation. The simulation platform consist of two modules namely software module that involved the multi agent based software and hardware module that involved the hardware simulation tool. In this research CPN tool is suggested as hardware module. The communication between two modules is created based on the XML communication and in the software modules HA is defined as a mediator between agents in the software module. The proposed simulation platform explained for RFIDMAMs in the FALs. For each part new case study is used for evaluation of the proposed system. Different cases are used for illustrating the ability of the proposed system in the different circumstances.

Conclusion for chapter 3

This chapter attempts to solve the scheduling problems of the agile manufacturing by using a multi-agent-based DSS. The proposed system is designed and developed in order to solve scheduling complexities during a dynamic order change and occurrence of internal disturbances in the manufacturing system. The design uses the capabilities of the MAS in order to solve real time scheduling complexities. Feasible and effective schedules are expected from negotiation/bidding mechanisms between agents. In this

study, we tried to clarify the problems of an agile manufacturing and how the MAS can be helpful. The MAS scheduling and control system is designed based on the PM and implemented in the JACK platform. The simulation platform based on a hybrid agent is used for simulation and testing. A real case study was used for simulation, and the results indicate that the proposed multi agent scheduling system outperforms the conventional approach as well as the dispatching-based production control approach used in practice. Furthermore, the proposed system performs better in terms of the running time because the MAS scheduling system can take immediate actions to reschedule tasks in the event of high failures. The developed method offers three advantages: (a) the dynamic order behavior and the capability to reconfigure the system with respect to the internal disturbances are considered simultaneously; (b) the system is developed based on general-purpose design methodology (i.e., Prometheus methodologyTM) and is not tied to any specific model in the software platform; and (c) for modeling the internal disturbances of the system, a simulation test platform is linked to the developed multi-agent-based DSS. The use of the developed system needs moderate knowledge on modeling manufacturing systems by Petri nets; this concern might be considered as disadvantage of this approach.

Conclusion for chapter 4

The complexity of manufacturing systems has increased to unprecedented levels, with a wide variety of products, procedures, and unexpected disturbances necessitating more agile, robust and reconfigurable control architectures. MASs play an important role in addressing this challenge by introducing distributed control with numerous autonomous and cooperative entities. This chapter proposed an efficient MAS-based manufacturing control system using IDCM inspired by ACI. The proposed IDCM was implemented in a RFIDMAMs. The major difference between this work and many

other existing agent manufacturing control systems is that it integrates ACI to solve the communication and resource breakdown problems besetting existing MASs. The proposed architecture was implemented in a real FAL factory as a case study, with two scenarios defined. A simulation platform for comparing two types of RFIDMAMs was also developed based on the existing simulation platform for the case study. In the results obtained, the RFIDMAMs +ant agent outperformed the conventional control platform. Furthermore, the proposed system exhibited superior performance in terms of run time, because the system could take immediate action to reschedule the process in the event of a large number of failures.

In future work, the related ant colony parameters that consider profit in more realistic and dynamic environments will be tuned and the intelligence of the agents, such as learning from a bidding history and making decisions based on appropriate tuning parameter selection, will be explored.

REFERENCES

- [1] ElMaraghy, W., ElMaraghy, H., Tomiyama, T., & Monostori, L. (2012). Complexity in engineering design and manufacturing. *CIRP Annals-Manufacturing Technology*, 61(2), 793-814.

- [2] Shen, W., & Norrie, D. H. (1999). Agent-based systems for intelligent manufacturing: a state-of-the-art survey. *Knowledge and information systems*, 1(2), 129-156.

- [3] Barenji, A. V. (2013). *An RFID-based distributed control system for flexible manufacturing system* (Doctoral dissertation, Eastern Mediterranean University (EMU)-Doğu Akdeniz Üniversitesi (DAÜ)).

- [4] Barenji, R. V., Hashemipour, M., Barenji, A. V., & Guerra-Zubiaga, D. A. (2012). Toward a framework for intra-enterprise competency modeling. In *2012 2nd International Conference on Advances in Computational Tools for Engineering Applications (ACTEA)*.

- [5] Chungoora, N., & Young, R. I. M. (2011). The configuration of design and manufacture knowledge models from a heavyweight ontological foundation. *International Journal of Production Research*, 49(15), 4701-4725.

- [6] Shen, W., & Norrie, D. H. (1999). Agent-based systems for intelligent manufacturing: a state-of-the-art survey. *Knowledge and information systems*, 1(2), 129-156.

- [7] Adetunla, A. O., Barenji, A. V., & Barenji, R. V. Developing manufacturing execution software as a service for small and medium size enterprise.
- [8] Pěchouček, M., & Mařík, V. (2008). Industrial deployment of multi-agent technologies: review and selected case studies. *Autonomous Agents and Multi-Agent Systems*, 17(3), 397-431.
- [9] McArthur, S. D., Davidson, E. M., Catterson, V. M., Dimeas, A. L., Hatziargyriou, N. D., Ponci, F., & Funabashi, T. (2007). Multi-agent systems for power engineering applications—Part II: Technologies, standards, and tools for building multi-agent systems. *IEEE Transactions on Power Systems*, 22(4), 1753-1759.
- [10] Barcnji, A. V., Barenji, R. V., & Sefidgari, B. L. (2013, August). An RFID-enabled distributed control and monitoring system for a manufacturing system. In *Innovative Computing Technology (INTECH), 2013 Third International Conference on* (pp. 498-503). IEEE.
- [11] Bussmann, S., Jennings, N. R., & Wooldridge, M. J. (2004). *Multiagent systems for manufacturing control: a design methodology*. Springer Science & Business Media.
- [12] Wooldridge, M., & Jennings, N. R. (1995). Intelligent agents: Theory and practice. *The knowledge engineering review*, 10(02), 115-152.

- [13] Leitao, P. J. P. (2004). *An agile and adaptive holonic architecture for manufacturing control* (Doctoral dissertation, University of Porto).
- [14] Leitão, P., & Restivo. (2006). A holonic architecture for agile and adaptive manufacturing control. *Computers in industry*, 57(2), 121-130.
- [15] Browne, J., Sackett, P. J., & Wortmann, J. C. (1995). Future manufacturing systems—towards the extended enterprise. *Computers in industry*, 25(3), 235-254.
- [16] Fujimoto, T. (1999). *The evolution of a manufacturing system at Toyota*. Oxford university press.
- [17] Obradovich, M. L. (2001). *U.S. Patent No. 6,275,231*. Washington, DC: U.S. Patent and Trademark Office.
- [18] Azizi, A., Barenji, A. V., & Hashmipour, M. (2016). Optimizing radio frequency identification network planning through ring probabilistic logic neurons. *Advances in Mechanical Engineering*, 8(8), 1687814016663476.
- [19] Suh, N. P., Cochran, D. S., & Lima, P. C. (1998). Manufacturing system design. *CIRP Annals-Manufacturing Technology*, 47(2), 627-639.
- [20] Sohlenius, G. (1992). Concurrent engineering. *CIRP Annals-Manufacturing Technology*, 41(2), 645-655.

- [21] Applegate, D., & Cook, W. (1991). A computational study of the job-shop scheduling problem. *ORSA Journal on computing*, 3(2), 149-156.
- [22] Kotha, S. (1996). From mass production to mass customization: the case of the National Industrial Bicycle Company of Japan. *European Management Journal*, 14(5), 442-450.
- [23] Hu, S. J. (2013). Evolving paradigms of manufacturing: From mass production to mass customization and personalization. *Procedia CIRP*, 7, 3-8.
- [24] Vatankhah Barenji, A., & Hashemipour, M. (2017). Real-Time Building Information Modeling (BIM) Synchronization Using Radio Frequency Identification Technology and Cloud Computing System. *Journal of Industrial and Systems Engineering*, 10, 0-0.
- [25] Tseng, M. M., Jiao, J., & Merchant, M. E. (1996). Design for mass customization. *CIRP Annals-Manufacturing Technology*, 45(1), 153-156.
- [26] Monden, Y. (2011). *Toyota production system: an integrated approach to just-in-time*. CRC Press.
- [27] Shah, R., & Ward, P. T. (2003). Lean manufacturing: context, practice bundles, and performance. *Journal of operations management*, 21(2), 129-149.
- [28] Taleghani, M. (2010). Key factors for implementing the lean manufacturing system. *Journal of American science*, 6(7), 287-291.

- [29] Da Silveira, G., Borenstein, D., & Fogliatto, F. S. (2001). Mass customization: Literature review and research directions. *International journal of production economics*, 72(1), 1-13.
- [30] Yusuf, Y. Y., Sarhadi, M., & Gunasekaran, A. (1999). Agile manufacturing:: The drivers, concepts and attributes. *International Journal of production economics*, 62(1), 33-43.
- [31] Kidd, P. T. (1995, October). Agile manufacturing: a strategy for the 21st century. In *Agile Manufacturing (Digest No. 1995/179)*, IEE Colloquium on(pp. 1-1). IET.
- [32] Gunasekaran, A. (1999). Agile manufacturing: a framework for research and development. *International journal of production economics*, 62(1), 87-105.
- [33] Barenji, A. V., Barenji, R. V., & Hashemipour, M. (2014). A frameworks for structural modelling of an RFID-enabled intelligent distributed manufacturing control system. *South African Journal of Industrial Engineering*, 25(2), 48-66.
- [34] Barenji, A. V., & Degirmenci, C. (2015, January). Robot Control System based on Web Application and RFID Technology. In *MATEC Web of Conferences* (Vol. 28). EDP Sciences.
- [35] Mehrabi, M. G., Ulsoy, A. G., & Koren, Y. (2000). Reconfigurable manufacturing systems: key to future manufacturing. *Journal of intelligent manufacturing*, 11(4), 403-419.

- [36] Fine, C. H., & Hax, A. C. (1985). Manufacturing strategy: a methodology and an illustration. *Interfaces*, 15(6), 28-46.
- [37] Gupta, Y. P., & Goyal, S. (1989). Flexibility of manufacturing systems: concepts and measurements. *European journal of operational research*, 43(2), 119-135.
- [38] Goldhar, J. D., & Jelinek, M. (1983). Plan for economies of scope. *Harvard Business Review*, 61(6), 141-148.
- [39] Swamidass, P. M., & Newell, W. T. (1987). Manufacturing strategy, environmental uncertainty and performance: a path analytic model. *Management science*, 33(4), 509-524.
- [40] Sharifi, H., & Zhang, Z. (1999). A methodology for achieving agility in manufacturing organisations: An introduction. *International journal of production economics*, 62(1), 7-22.
- [41] Browne, M. W. (1984). Asymptotically distribution-free methods for the analysis of covariance structures. *British Journal of Mathematical and Statistical Psychology*, 37(1), 62-83.
- [42] Sethi, A. K., & Sethi, S. P. (1990). Flexibility in manufacturing: a survey. *International journal of flexible manufacturing systems*, 2(4), 289-328.
- [43] Shewchuk, J. P. (1998). Agile manufacturing: one size does not fit all. In *Strategic Management of the Manufacturing Value Chain* (pp. 143-150). Springer US.

- [44] Swafford, P. M., Ghosh, S., & Murthy, N. (2008). Achieving supply chain agility through IT integration and flexibility. *International Journal of Production Economics*, 116(2), 288-297.
- [45] Gunasekaran, A., Patel, C., & Tirtiroglu, E. (2001). Performance measures and metrics in a supply chain environment. *International journal of operations & production Management*, 21(1/2), 71-87.
- [46] Maskell, B. (2001). The age of agile manufacturing. *Supply Chain Management: An International Journal*, 6(1), 5-11.
- [47] Lasi, H., Fettke, P., Kemper, H. G., Feld, T., & Hoffmann, M. (2014). Industry 4.0. *Business & Information Systems Engineering*, 6(4), 239.
- [48] Graves, S. C. (1981). A review of production scheduling. *Operations research*, 29(4), 646-675.
- [49] Thomas E., Vollmann, William L., Berry, & Whybark, D. C. (1997). *Manufacturing planning and control systems*. Irwin/McGraw-Hill.
- [50] Shen, W., Hao, Q., Yoon, H. J., & Norrie, D. H. (2006). Applications of agent-based systems in intelligent manufacturing: An updated review. *Advanced engineering INFORMATICS*, 20(4), 415-431.
- [51] Shen, W. (2002). Distributed manufacturing scheduling using intelligent agents. *IEEE intelligent systems*, 17(1), 88-94.

- [52] Shen, W., Wang, L., & Hao, Q. (2004). Agent-based integration of manufacturing process planning and scheduling: a review.
- [53] Brennan, R. W., Balasubramanian, S., & Norrie, D. H. (1997, December). Dynamic control architecture for metamorphic control of advanced manufacturing systems. In *Intelligent Systems & Advanced Manufacturing*(pp. 213-223). International Society for Optics and Photonics.
- [54] Trentesaux, D. (2009). Distributed control of production systems. *Engineering Applications of Artificial Intelligence*, 22(7), 971-978.
- [55] Baker, A. D. (1998). A survey of factory control algorithms that can be implemented in a multi-agent heterarchy: dispatching, scheduling, and pull. *Journal of Manufacturing Systems*, 17(4), 297-320.
- [56] Wang, L., & Shen, W. (Eds.). (2007). *Process planning and scheduling for distributed manufacturing*. Springer Science & Business Media.
- [57] Barbosa, J. (2015). *Self-organized and evolvable holonic architecture for manufacturing control* (Doctoral dissertation, Université de Valenciennes et du Hainaut-Cambresis).
- [58] Mishra, N., Singh, A., Kumari, S., & Govindan, K. (2016). Cloud-based multi-agent architecture for effective planning and scheduling of distributed manufacturing. *International Journal of Production Research*, 1-14.

- [59] Evans, P. C., & Annunziata, M. (2012). Industrial internet: Pushing the boundaries of minds and machines. *General Electric. November, 26*.
- [60] Maes, P. (1997). General tutorial on software agents. *Massachusetts (March 25, 2002) <http://pattie.www.media.mit.edu/people/pattie/CHI97>*.
- [61] Nwana, H. S. (1996). Software agents: An overview. *The knowledge engineering review, 11(03)*, 205-244.
- [62] S Smith, R. The contract net protocol: Highlevel communication and control in a distributed problem solver, 1980. *IEEE Trans. on Computers, C, 29, 12*.
- [63] Gunasekaran, A., & Yusuf, Y. Y. (2002). Agile manufacturing: a taxonomy of strategic and technological imperatives. *International Journal of Production Research, 40(6)*, 1357-1385.
- [64] Finin, T., Fritzson, R., McKay, D., & McEntire, R. (1994, November). KQML as an agent communication language. In *Proceedings of the third international conference on Information and knowledge management* (pp. 456-463). ACM.
- [65] O'Brien, P. D., & Nicol, R. C. (1998). FIPA—towards a standard for software agents. *BT Technology Journal, 16(3)*, 51-59.
- [66] Gruber, T. R. (1993). A translation approach to portable ontology specifications. *Knowledge acquisition, 5(2)*, 199-220.

- [67] Guarino, N. (1998, June). Formal ontology and information systems. In *Proceedings of FOIS* (Vol. 98, No. 1998, pp. 81-97).
- [68] Jennings, N. R., & Wooldridge, M. (1998). Applications of intelligent agents. In *Agent technology* (pp. 3-28). Springer Berlin Heidelberg.
- [69] Shaw, M. J. (1988). Dynamic scheduling in cellular manufacturing systems: a framework for networked decision making. *Journal of Manufacturing Systems*, 7(2), 83-94.
- [70] Parunak, H. V. D. (1987). Manufacturing experience with the contract net. *Distributed artificial intelligence*, 1, 285-310.
- [71] Wu, J. (2008, December). Contract net protocol for coordination in multi-agent system. In *Intelligent Information Technology Application, 2008. IITA'08. Second International Symposium on* (Vol. 2, pp. 1052-1058). IEEE.
- [72] Shaygan, A., & Barenji, R. V. (2016). Simulation Platform for Multi Agent Based Manufacturing Control System Based on The Hybrid Agent. *arXiv preprint arXiv:1603.07766*.
- [73] Barenji, A. V., Barenji, R. V., & Hashemipour, M. (2016). Flexible testing platform for employment of RFID-enabled multi-agent system on flexible assembly line. *Advances in Engineering Software*, 91, 1-11.

- [74] Vrba, P. (2006). Simulation in agent-based control systems: MAST case study. *International Journal of Manufacturing Technology and Management*, 8(1-3), 175-187.
- [75] Vrba, P., & Marik, V. (2010). Capabilities of dynamic reconfiguration of multiagent-based industrial control systems. *IEEE Transactions on Systems, Man, and Cybernetics-Part A: Systems and Humans*, 40(2), 213-223.
- [76] Bal, M. M. (2007). Applications of Virtual Reality and Simulation of Holonic Manufacturing Systems: A Demonstration in Die-Casting Industry. In *Holonic and Multi-Agent Systems for Manufacturing* (pp. 421-432). Springer.
- [77] Barenji, R. V., Barenji, A. V., & Hashemipour, M. (2014). A multi-agent RFID-enabled distributed control system for a flexible manufacturing shop. *The International Journal of Advanced Manufacturing Technology*, 71(9-12), 1773-1791.
- [78] Vatankhah Barenji, A., & Hashemipour, M. (2017). Real-Time Building Information Modeling (BIM) Synchronization Using Radio Frequency Identification Technology and Cloud Computing System. *Journal of Industrial and Systems Engineering*, 10, 0-0.
- [79] Roudi, D., & Barenji, A. V. A Dynamic Multi Agent based scheduling for flexible flow line manufacturing system: UPVC Door and Window Company.

- [80] Xiang, W., & Lee, H. P. (2008). Ant colony intelligence in multi-agent dynamic manufacturing scheduling. *Engineering Applications of Artificial Intelligence*, 21(1), 73-85.
- [81] Sarac, A., Absi, N., & Dautère-Pères, S. (2010). A literature review on the impact of RFID technologies on supply chain management. *International Journal of Production Economics*, 128(1), 77-95.
- [82] Huang, G. Q., Zhang, Y. F., & Jiang, P. Y. (2008). RFID-based wireless manufacturing for real-time management of job shop WIP inventories. *The International Journal of Advanced Manufacturing Technology*, 36(7-8), 752-764.
- [83] Doomun, R., & Vunka Jungum, N. (2008). Business process modelling, simulation and reengineering: call centres. *Business Process Management Journal*, 14(6), 838-848.
- [84] Thimm, G., Lee, S. G., & Ma, Y. S. (2006). Towards unified modelling of product life-cycles. *Computers in Industry*, 57(4), 331-341.
- [85] Liu, M. R., Zhang, Q. L., Ni, L. M., & Tseng, M. M. (2004, December). An RFID-based distributed control system for mass customization manufacturing. In *International Symposium on Parallel and Distributed Processing and Applications*. Springer.

- [86] Bellifemine, F., Bergenti, F., Caire, G., & Poggi, A. (2005). JADE—a java agent development framework. In *Multi-Agent Programming* (pp. 125-147). Springer US.
- [87] Tudorache, T., Noy, N. F., Tu, S., & Musen, M. A. (2008, October). Supporting collaborative ontology development in Protégé. In *International Semantic Web Conference* (pp. 17-32). Springer Berlin Heidelberg.
- [88] Meyer, G. G., Främling, K., & Holmström, J. (2009). Intelligent products: A survey. *Computers in industry*, *60*(3), 137-148.
- [89] Liu, W. N., Zheng, L. J., Sun, D. H., Liao, X. Y., Zhao, M., Su, J. M., & Liu, Y. X. (2012). RFID-enabled real-time production management system for Loncin motorcycle assembly line. *International Journal of Computer Integrated Manufacturing*, *25*(1), 86-99.
- [90] Ezpeleta, J., Colom, J. M., & Martinez, J. (1995). A Petri net based deadlock prevention policy for flexible manufacturing systems. *IEEE transactions on robotics and automation*, *11*(2), 173-184.
- [91] DiCesare, F., Harhalakis, G., Proth, J. M., Silva, M., & Vernadat, F. B. (1993). *Practice of Petri nets in manufacturing* (p. 8). London: Chapman & Hall.
- [92] Young, R. E., & Vesterager, J. (1990). An approach to implementing CIM in small and medium size companies. *International Journal of NIST Special Publication*, *785*, 63-79.

- [93] Levy, M., & Powell, P. (2000). Information systems strategy for small and medium sized enterprises: an organisational perspective. *The Journal of Strategic Information Systems*, 9(1), 63-84.
- [94] Bai, D., Zhang, Z. H., & Zhang, Q. (2016). Flexible open shop scheduling problem to minimize makespan. *Computers & Operations Research*, 67, 207-215.
- [95] Vatankhah Barenji, R., Hashemipour, M., & Guerra-Zubiaga, D. A. (2015). A framework for modelling enterprise competencies: from theory to practice in enterprise architecture. *International Journal of Computer Integrated Manufacturing*, 28(8), 791-810.
- [96] Monostori, L., Váncza, J., & Kumara, S. R. (2006). Agent-based systems for manufacturing. *CIRP Annals-Manufacturing Technology*, 55(2), 697-720.
- [97] Lu, S. H., & Kumar, P. R. (1991). Distributed scheduling based on due dates and buffer priorities. *IEEE Transactions on Automatic Control*, 36(12), 1406-1416.
- [98] Barenji, A. V., Barenji, R. V., & Hashemipour, M. (2013, June). Structural modeling of a RFID-enabled reconfigurable architecture for a flexible manufacturing system. In *Smart Objects, Systems and Technologies (SmartSysTech), Proceedings of 2013 European Conference on* (pp. 1-10). VDE.

- [99] Barenji, A. V., Barenji, R. V., Roudi, D., & Hashemipour, M. (2016). A dynamic multi-agent-based scheduling approach for SMEs. *The International Journal of Advanced Manufacturing Technology*, 1-15.
- [100] Kerzner, H. R. (2013). *Project management: a systems approach to planning, scheduling, and controlling*. John Wiley & Sons.
- [101] Yoon, H. J., & Shen, W. (2008). A multiagent-based decision-making system for semiconductor wafer fabrication with hard temporal constraints. *IEEE Transactions on Semiconductor Manufacturing*, 21(1), 83-91.
- [102] Thomas E.. Vollmann, William L.. Berry, & Whybark, D. C. (1997). *Manufacturing planning and control systems*. Irwin/McGraw-Hill.
- [103] Ramamritham, K., & Stankovic, J. A. (1994). Scheduling algorithms and operating systems support for real-time systems. *Proceedings of the IEEE*, 82(1), 55-67.
- [104] Yoon, H. J., & Shen, W. Agent-based scheduling mechanism for semiconductor manufacturing systems with temporal constraints. In *IEEE International Conference Mechatronics and Automation, 2005* (Vol. 2, pp. 1123-1128). IEEE.
- [105] Caridi, M., & Cavalieri, S. (2004). Multi-agent systems in production planning and control: an overview. *Production Planning & Control*, 15(2), 106-118.

- [106] Gibson, M. R., Ohlmann, J. W., & Fry, M. J. (2010). An agent-based stochastic ruler approach for a stochastic knapsack problem with sequential competition. *Computers & Operations Research*, 37(3), 598-609.
- [107] Valckenaers, P., & Van Brussel, H. (2005). Holonic manufacturing execution systems. *CIRP Annals-Manufacturing Technology*, 54(1), 427-432.
- [108] Kaplanoğlu, V. (2014). Multi-agent based approach for single machine scheduling with sequence-dependent setup times and machine maintenance. *Applied Soft Computing*, 23, 165-179.
- [109] Chen, K. Y., & Chen, C. J. (2010). Applying multi-agent technique in multi-section flexible manufacturing system. *Expert Systems with Applications*, 37(11), 7310-7318.
- [110] Padgham, L., & Winikoff, M. (2002, July). Prometheus: A methodology for developing intelligent agents. In *International Workshop on Agent-Oriented Software Engineering* (pp. 174-185). Springer Berlin Heidelberg.
- [111] Padgham, L., & Winikoff, M. (2002, November). Prometheus: A pragmatic methodology for engineering intelligent agents. In *Proceedings of the OOPSLA 2002 Workshop on Agent-Oriented Methodologies* (pp. 97-108).
- [112] Baykasoglu, A., & Gorkemli, L. (2016). Dynamic virtual cellular manufacturing through agent-based modelling. *International Journal of Computer Integrated Manufacturing*, 1-16.

- [113] Sahin, C., Demirtas, M., Erol, R., Baykasoğlu, A., & Kaplanoğlu, V. (2015). A multi-agent based approach to dynamic scheduling with flexible processing capabilities. *Journal of Intelligent Manufacturing*, 1-19.
- [114] Padgham, L., & Winikoff, M. (2005). Prometheus: A practical agent-oriented methodology. *Agent-oriented methodologies*, 107-135.
- [115] Padgham, L., Thangarajah, J., & Winikoff, M. (2007, May). The Prometheus design tool—a conference management system case study. In *International Workshop on Agent-Oriented Software Engineering* (pp. 197-211). Springer Berlin Heidelberg.
- [116] Padgham, L., & Winikoff, M. (2005). *Developing intelligent agent systems: A practical guide* (Vol. 13). John Wiley & Sons.
- [117] Bordini, R. H., Dastani, M., & Winikoff, M. (2006, September). Current issues in multi-agent systems development. In *International Workshop on Engineering Societies in the Agents World* (pp. 38-61). Springer Berlin Heidelberg.
- [118] Gascueña, J. M., & Fernández-Caballero, A. (2011). Agent-oriented modeling and development of a person-following mobile robot. *Expert Systems with Applications*, 38(4), 4280-4290.
- [119] Winikoff, M. (2005). JACK™ intelligent agents: an industrial strength platform. In *Multi-Agent Programming* (pp. 175-193). Springer US.

- [120] Ratzer, A. V., Wells, L., Lassen, H. M., Laursen, M., Qvortrup, J. F., Stissing, M. S., ... & Jensen, K. (2003, June). CPN tools for editing, simulating, and analysing coloured Petri nets. In *International Conference on Application and Theory of Petri Nets* (pp. 450-462). Springer berlin Heidelberg.
- [121] Lim, M. K., & Zhang, Z. (2003). A multi-agent based manufacturing control strategy for responsive manufacturing. *Journal of Materials Processing Technology*, 139(1), 379-384.
- [122] Barenji, R. V., Hashemipour, M., Barenji, A. V., & Guerra-Zubiaga, D. A. (2012). Toward a framework for intra-enterprise competency modeling. In *2012 2nd International Conference on Advances in Computational Tools for Engineering Applications (ACTEA)*.
- [123] Babiceanu, R. F., Chen*, F. F., & Sturges, R. H. (2004). Framework for the control of automated material-handling systems using the holonic manufacturing approach. *International Journal of Production Research*, 42(17), 3551-3564.
- [124] Valckenaers, Saint Germain, Verstraete, & Van Brussel. (2007). MAS coordination and control based on stigmergy. *Computers in Industry*, 58(7), 621-629.
- [125] Barenji, A. V., & Degirmenci, C. (2015, January). Robot Control System based on Web Application and RFID Technology. In *MATEC Web of Conferences* (Vol. 28). EDP Sciences.

- [126] Leitão, Barbosa, J., & Trentesaux, D. (2014). inspired multi-agent systems for reconfigurable manufacturing systems. *Engineering Applications Artificial Intelligence*, 20(5), 934-944.
- [127] Smith, R. The contract net protocol: Highlevel communication and control in a distributed problem solver, 1980. *IEEE Trans. on Computers*, C, 29, 12.
- [128] Cappelli, P. (1999). *The new deal at work: Managing the market-driven workforce*. Harvard Business Press.
- [129] Jégou, D., Kim, D. W., Baptiste, P., & Lee, K. H. (2006). A contract net based intelligent agent system for solving the reactive hoist scheduling problem. *Expert systems with applications*, 30(2), 156-167.
- [130] Nwana, H. S., Lee, L. C., & Jennings, N. R. (1996). Coordination in software agent systems. *British Telecom Technical Journal*, 14(4), 79-88.
- [131] Garnier, S., Gautrais, J., & Theraulaz, G. (2007). The biological principles of swarm intelligence. *Swarm Intelligence*, 1(1), 3-31.
- [132] Valckenaers, P., Van Brussel, H., Kollingbaum, M., & Bochmann, O. (2001). Multi-agent coordination and control using stigmergy applied to manufacturing control. In *Multi-agent systems and applications* (pp. 317-334). Springer Berlin Heidelberg.

- [133] Cicirello, V. A., & Smith, S. F. (2001, August). Insect societies and manufacturing. In *The IJCAI-01 Workshop on Artificial Intelligence and Manufacturing: New AI Paradigms for Manufacturing* (pp. 33-38)..
- [134] Holland, O., & Melhuish, C. (1999). Stigmergy, self-organization, and sorting in collective robotics. *Artificial life*, 5(2), 173-202.
- [135] Bonabeau, E., Sobkowski, A., Theraulaz, G., & Deneubourg, J. L. (1997, January). Adaptive Task Allocation Inspired by a Model of Division of Labor in Social Insects. In *BCEC* (pp. 36-45).
- [136] Gao, Q., Luo, X., & Yang, S. (2005). Stigmergic cooperation mechanism for shop floor control system. *The International Journal of Advanced Manufacturing Technology*, 25(7-8), 743-753.
- [137] Theraulaz, G., & Bonabeau, E. (1999). A brief history of stigmergy. *Artificial life*, 5(2), 97-116.
- [138] Parunak, H. V. D. (2003, January). Making swarming happen. In *Proceedings of Swarming and Network-Enabled C4ISR*.
- [139] P. Valckenaers, M. Kollingbaum, and H. Van Brussel, "Multi-agent coordination and control using stigmergy," *Computers in industry*, vol. 53, pp. 75-96, 2004.
- [140] M. Dorigo, E. Bonabeau, and G. Theraulaz, "Ant algorithms and stigmergy," *Future Generation Computer Systems*, vol. 16, pp. 851-871, 2000.

- [141] Hadeli, K., Valckenaers, P., Zamfirescu, C., Van Brussel, H., Saint Germain, B., Hoelvoet, T., & Steegmans, E. (2003, July). Self-organising in multi-agent coordination and control using stigmergy. In *International Workshop on Engineering Self-Organising Applications* (pp. 105-123). Springer Berlin Heidelberg.
- [142] Duan, J., Zhu, Y. A., & Huang, S. (2012, July). Stigmergy agent and swarm-intelligence-based multi-agent system. In *Intelligent Control and Automation (WCICA), 2012 10th World Congress on* (pp. 720-724). IEEE.
- [143] Tripp, H., & Palmer, P. (2011). Stigmergy for nanosatellite cluster coordination without intersatellite links. *Journal of Aerospace Computing, Information, and Communication*, 8(5), 127-150.
- [145] Bellifemine, F., Poggi, A., & Rimassa, G. (2001). Developing multi-agent systems with a FIPA-compliant agent framework. *Software-Practice and Experience*, 31(2), 103-128..
- [146] Vatankhah Barenji, A., & Hashemipour, M. (2017). Real-Time Building Information Modeling (BIM) Synchronization Using Radio Frequency Identification Technology and Cloud Computing System. *Journal of Industrial and Systems Engineering*, 10, 0-0.