

Localization of Wireless Sensor Network Using Triangulation in Industrial Environment

MohammadRahim Zeraat Talab Motlagh

Submitted to the
Institute of Graduate Studies and Research
in partial fulfillment of the requirements for the Degree of

Master of Science
in
Mechanical Engineering

Eastern Mediterranean University
January 2013
Gazimağusa, North Cyprus

Approval of the Institute of Graduate Studies and Research

Prof. Dr. Elvan Yılmaz
Director

I certify that this thesis satisfies the requirements as a thesis for the degree of Master of Science in Mechanical Engineering.

Assoc. Prof. Dr. Uğur Atikol
Chair, Department of Mechanical Engineering

We certify that we have read this thesis and that in our opinion it is fully adequate in scope and quality as a thesis for the degree of Master of Science in Mechanical Engineering.

Prof. Dr. Majid Hashemipour
Supervisor

Examining Committee

1. Prof. Dr. Majid Hashemipour

2. Assist. Prof. Dr. Sahand Daneshvar

3. Assist. Prof. Dr. Neriman Özada

ABSTRACT

Wireless sensor networks (WSNs) have important role in new generation of manufacturing systems due to the fact that is an infrastructure comprised of computing, measuring and communication elements that gives the ability to users to observe, instrument and react to events and phenomena in a specified environment. In wireless sensor networks one of the significant problems is the localization of sensor nodes based on the location of several nodes.

The main object of the current study is to simulate triangulation method based on received signal strength indicator (RSSI) as distance estimation measurement in industrial environment.

In the theoretical part with using Cartesian coordinates four networked transceivers arranged in a triangular pattern and each one equipped with one anchor node. Then with utility of RSSI equation have calculated the position of unknown node of more than hundred points. The first experimental environment has done at the exterior space and without any equipment and in very quiet place. The coordinate system in this experiment was performed on ground and also RSSI was calculated for every meter on x and yaxis separately. Then for making comparison, the theoretical results for RSSI were achieved from Friss equation. The second experimental part was done in the industrial environment with lots of mechanical machines and manufacturing tools and same as first experiment in two dimension but reverse of first experiment in this part there was too many noises. After comparison RSSI errors between second experimental environment

and Friss equation, results show that simulation of triangulation method based on RSSI in industrial environment is executable. At the final part of thesis the comparison was done between three localization methods that were researched in EMU.

Keywords: Wireless Sensor Networks, Localization, Triangulation, Received Signal Strength Indicator

ÖZ

Kablosuz algılayıcı şebeke (telsiz duyurga ağları) yeni nesil üretim sistemlerinde, muhasebe, ölçme ve irtibat unsurlarının karmaşık altyapısı olduğuna göre önemli bir role sahip olmaktadır. Ayrıca kullanıcılara özel çevrelerde fenomenler hakkında gözlemcilik ve tepki ayrıcalığı tanır. Kablosuz algılayıcı şebekede önemli sorulardan biri algılayıcı düğümleri yerel düğümler esasında yerelleştirmektedir.

Bu çalışmanın asıl amacı, endüstriyel ortamda alınan sinyal gücü göstergesi esasında nirengi metod benzetmesi ile mesafe tahmininde bulunmaktadır.

Teorik bölümünde Kartezyen koordinatlar ağlarını kullanarak çapa düğümlerle donatılmış şebeke alıcılarını üçgen şeklinde düzeni vardır. Sonra RSSI formülünü kullanarak bilinmeyen düğümün konumunun yüzden fazla noktada belirtiyoruz. İlk deney sessiz herhangi bir cihaz ve donanım olmayan dış ortamda yapıldı. Bu deneyde koordinat sistemi zeminde yapıldı ve ayrıca RSSI miktarı x ve y eksenleri üzerinde ayrı ayrı ölçüldü. Sonra, karşılaştırma yapmak için RSSI miktarı teorik sonuçları Friss formülü ile elde edildi. İkinci deney ise endüstriyel ortamda birçok makine ve üretim araçları bulunan gürültülü bir mekânda yapıldı. Bu deney birinci deney gibi iki boyutta x ve y eksenleri üzerinde ama birinci deneyin tersine çok fazla gürültülü mekânda yapıldı. İkinci deneyin RSSI sonuçlarını Friss formülünden muhasibe olan yanılırları karşılaştırdıktan sonra, RSSI esasında nirengi metodunun simülasyonu endüstriyel ortamda

çalıřtırılabıleceęi kanaatine varıyoruz. Tezin son kısmında DAÜ'de yapılan üç ayrı yerelleřtirme yöntemlerini tezdeki yöntemle karşılařtırıyoruz.

Anahtar Kelimeler: Kablosuz Algılayıcı Ağlar, Yerelleřtirme, Nirengi, Sinyal Gücü Göstergesi Zamanı

ACKNOWLEDGEMENT

I want to thank my supervisor Prof Dr. MAJID HASHEMIPOUR not only for his supervisory, supporting and guiding for this thesis also for providing me the opportunity for researching, reading and writing. He has shown me the co working and also how can be a good engineer and manager.

In continue my great thank for Dr REZA ABRISHAMBAF in EMU- Electrical & Electronic Engineering department.

Besides I want to thank my old friend POORYA GHAFORPOOR YAZDI that truly helped me in this thesis.

My last words is for my parents who pray amorously for my successfully. Thank you for everything.

TABLE OF CONTENTS

ABSTRACT	iii
ÖZ	v
ACKNOWLEDGEMENT	vii
LIST OF TABLES	xi
LIST OF FIGURES	xii
1 INTRODUCTION	1
2 LITERATURE REVIEW	5
2.1 Wireless Sensor Networks	5
2.2 Hardware Platform	6
2.3 Wireless Sensor Networks Applications	7
2.3.1 Home Control	7
2.3.2 Industrial Applications	8
2.3.3 Health Applications	9
2.3.4 Environment Applications	10
2.4 Applications of WSNs in Manufacturing	11
2.4.1 Inventory Tracking	12
2.4.2 In Process Part Tracking	13

2.4.3	Monitoring	13
2.4.4	Environment Tracking.....	14
3	LOCALIZATION OF WIRELESS SENSOR NETWORKS.....	16
3.1	WSNs Localization	16
3.2	Main Phases of Localization Algorithms.....	17
3.2.1	Distance Estimation Techniques.....	17
3.2.1.1	Angle of Arrival	17
3.2.1.2	Time of Arrival	17
3.2.1.3	Time Different Of Arrival.....	17
3.2.1.4	Received Signal Strength Indicator	18
3.2.2	Measurement Techniques for Position Computation.....	18
3.2.2.1	Lateration and Trilateration	18
3.2.2.2	Angulation and Triangulation.....	18
3.2.3	Localization Algorithm	19
3.2.3.1	Individual-Hop and Multi-Hop Algorithms	19
3.2.3.2	Span-Based and Span-Free Localization	19
3.2.3.3	Intensive and Divided Localization	20
3.2.3.4	Beacon-Based and Beacon-Free Localization	20
4	TRIANGULATION LOCALIZATION METHOD.....	21
5	METHODOLOGY AND EXPERIMENTATION.....	25

5.1	First Experimental Method	25
5.2	Friss Equation	26
5.3	Common Position Estimation	29
5.4	Industrial Environment	30
5.5	Compared Errors Between Three Localization Methods	34
6	CONCLUSION.....	37
	REFERENCES	39

LIST OF TABLES

Table 1: Measured Rssi For The Experimental Method	26
Table 2: Compared Position By First Experimental Environme And Triangulation.....	27
Table 3: Compared Position By Common Position Estimation And Triangulation	29
Table 4: Measured RSSI In Workshop of University.....	38
Table 5: Compared Errors between Three Localization Method.....	42

LIST OF FIGURES

Figure 1: The Five Basic Information Functions	5
Figure 2: Hardware And Software Components Of WSNs	6
Figure 3: Home Control Application	8
Figure 4: Industrial Control Application.....	9
Figure 5 : Medical Application	10
Figure 6: Weather Application	11
Figure 7: Industrial Application	12
Figure 8: Inventory Tracking	13
Figure 9: Monitoring.....	14
Figure 10: Condition Monitoring Of Machine	15
Figure 11: Sensor Placement In The Array	22
Figure 12: First Experimentation In The Free Space.....	25
Figure 13: Comparison Rssi Errors Between First Experiment And Friss Equation	27
Figure 14: Error Between Triangulation Method And Common Position Estimation	30
Figure 15: View Of Workshop After Implementing The Sensor Nodes	31
Figure 16(a, b): Practical Work In The Workshop	32
Figure 17: Total Average Between Friss Equation And Second Experiment	33
Figure 18: Fuzzy Logic Method	34
Figure 19: Simulation Result Of Fuzzy Logic Method	35
Figure 20: Simulation Result Of Trilateration Method	36

Chapter 1

INTRODUCTION

Today, congruence of the Internet, communications, and information technologies, along with recent progress in engineering, have made it possible to introduce a new generation of inexpensive sensors and actuators which are able to gain a high spatial and temporal resolution and accuracy. These technologies may include electric sensors, sensor arrays, laser radars, navigation sensors etc.

Nowadays, use of (WSNs) for industrial purposes has drawn much attention. In contrast to office networks, wireless networks of industrial environment have more disturbances because of the unpredictable changing's in physical conditions such as temperature, pressure, damp and so on.

Wireless sensor network is a system composed of large number of wirelessly connected heterogeneous sensor nodes (hundreds or thousands) that are spatially dispersed through large domains of interest. To determine and break down data of system factors, a wide range of sensors are employed. The sensor nodes are usually prepared with devices such as radio transceivers and batteries. These devices have small size, low price and could be used in large amounts. In addition, with a small amount of power, they can work for years. These devices are connected via the wireless network and information is fused to

extract useful and exact information. WSNs are used in different fields like agriculture, environment & habitat monitoring, military, manufacturing, etc [1].

Locality of sensors with unknown information about location is measured by sensor network localization algorithms using information about the mere positions characteristics of some sensors and inter-sensor like distance and bearing properties. Sensors with known position information are called beacons those locations could be determined by global positioning system (GPS) or by positioning anchors at places with known coordinates [2].

Received signal strength indicator (RSSI) is the simplest and cheapest techniques among approaches that measure range, because it does not need to particular extra hardware. Moreover, in real situation, this index is greatly affected by noises, barriers and node type which make it difficult to establish a mathematical model [3].

One method for finding location of unknown nodes is localization triangulation method in which three or four known nodes along with (RSSI) signal as distance based measurement are used. In this method, three to four networked transceivers - equipped with unidirectional antennas - which are set up in a triangular pattern could determine both transmitter's power level and the Cartesian coordinates (x, y) of the transmitter in relation to the receivers while they communicate their RSSI information [4].

In wireless sensor network, one of the major questions is the location of the unknown sensor nodes. There are two categories of node in wireless sensor networks: anchor nodes and unknown sensor nodes. The sensor nodes know their locations called beacon. Anchor

nodes involve energy and accurate information about their position while unknown sensor nodes do not have these properties. In this thesis, for localization problem of WSNs unknown nodes a solution has been defined by utilizing triangulation as a localization algorithm also particularly this method has been investigated for manufacturing applications.

In the theoretical part with using Cartesian coordinates four networked transceivers arranged in a triangular pattern and each one equipped with one anchor node. Then with utility of RSSI equation have calculated the position of unknown node of more than hundred points. The first experimental environment has done at the exterior space and without any equipment and in very quiet place. The coordinate system in this experiment was performed on ground and also RSSI was calculated for every meter on x and y axis separately. Then for making comparison, the theoretical results for RSSI were achieved from Friss equation. The second experimental part was done in the industrial environment with lots of mechanical machines and manufacturing tools and same as first experiment in two dimension but reverse of first experiment in this part there was too many noises. After comparison RSSI errors between second experimental environment and Friss equation, results show that simulation of triangulation method based on RSSI in industrial environment is executable. At the final part of thesis the comparison was done between three localization methods that were researched in EMU.

In chapter two there is some explanation about wireless sensor networks and general applications of that and then some comments about applications of WSNs especially in manufacturing. In third chapter with going inside the main part of thesis localization of

WSNs, describe different phases of localization. Chapter four is completely about triangulation method and estimates the location of unknown node. Fifth chapter is methodology and experimental part and describe the comparisons were done to get the errors and results and finally in last chapter, conclusion, with briefly explain about what was done in thesis, some suggestion and solution is given for future work.

Chapter 2

LITERATURE REVIEW

2.1 Wireless sensor networks

Obtaining Information has always been an important issue for people. Thus, why is the contemporary era called the Information Age? The primary answer to this question is the extensive hardware and software facilities existing today for obtaining, communicating, processing, storing, and using information. All of these basic operations have been growing strikingly since progression in micro-electronics and micro-magnetic technologies as well as in the radio-frequency and optical communications [5].

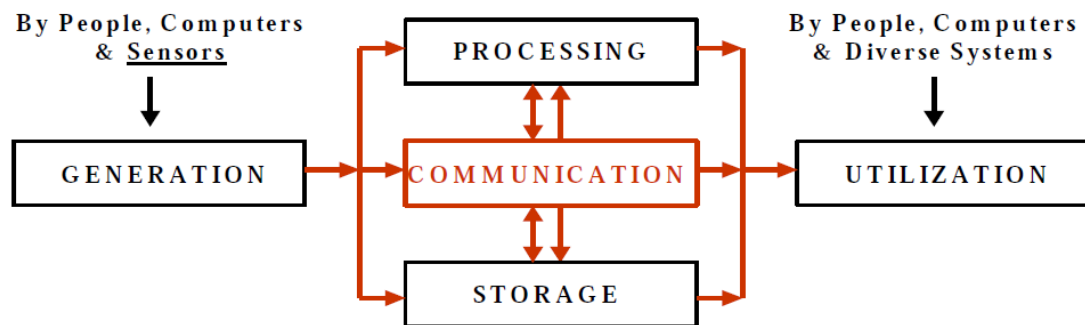

Figure 1: The five basic information functions [5]

2.2 Hardware Platform

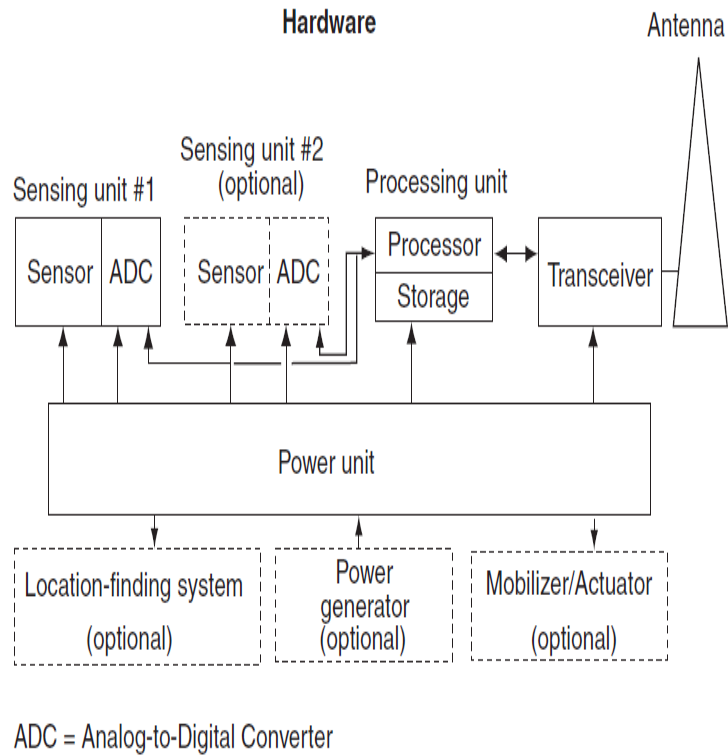

Figure 2: Hardware and software components of WSNs [5]

WSNs have four essential hardware components that is shown in figure 2 are include:

1. Power
2. Computational logic and storage
3. Sensor transducer(s)
4. Communication

2.3 Wireless Sensor Networks Applications

To enumerate different applications of wireless sensor systems and networks, there would be many lists and categories. Wireless sensor nodes have ability to sense the physical conditions, communicate with adjacent nodes, most of the time; perform basic computations on collected data. WSN supports a wide range of helpful applications as follows [6]:

2.3.1 Home Control

This kind of appealing could be used for operations such as control, keeping and convenience, as continues and mention in figure 3:

- Sensing usage provide an efficient management for lighting, and cooling facilities, anywhere inside home.
- Sense appealing automatism the control of various house systems toward recover energy saving, comfort, and safety.
- Sensing applications can provide highly precise water, gas usage information.
- Sensing applications provide one with ability to operate various systems using alone remote control device.
- Sense appealing can provide a straight installing the wireless sensors to control and regulate various conditions.
- Sensing usage may provide a facility to receive automatic notification in the case of detecting an uncommon event [6].

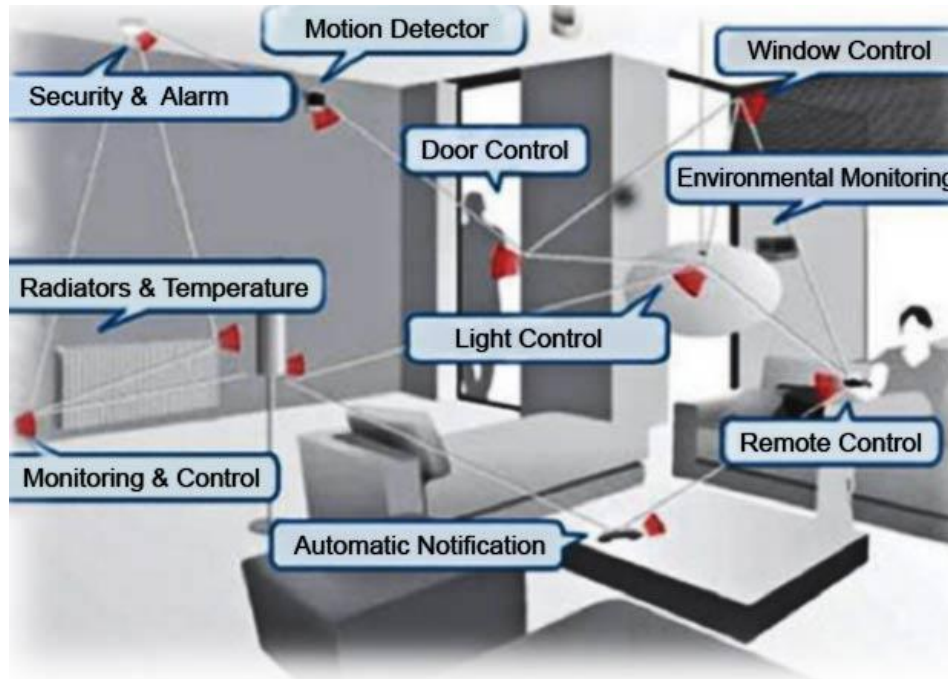

Figure 3: Home control application

2.3.2 Industrial Applications

Industrial automation process can support better flexibility, control, safety, and conservation, as follows and mention in figure 4:

- Using sensing applications can increase reliability of current manufacturing systems.
- Using sensing applications can make better asset control by constant monitoring for crucial devices.
- Sense appealing can decrease energy expenditure by optimizing manufacturing operations.
- Sense appealing help identifying in competent tasks or poorly working tools..
- Sense appealing help collecting data automatically from remote sensors to decrease user intermediation.

- Sense appealing help providing elaborated information to make better preventative protector programs.
- Sense usage helps positioning the monitoring systems to increase staffs and public security [6].

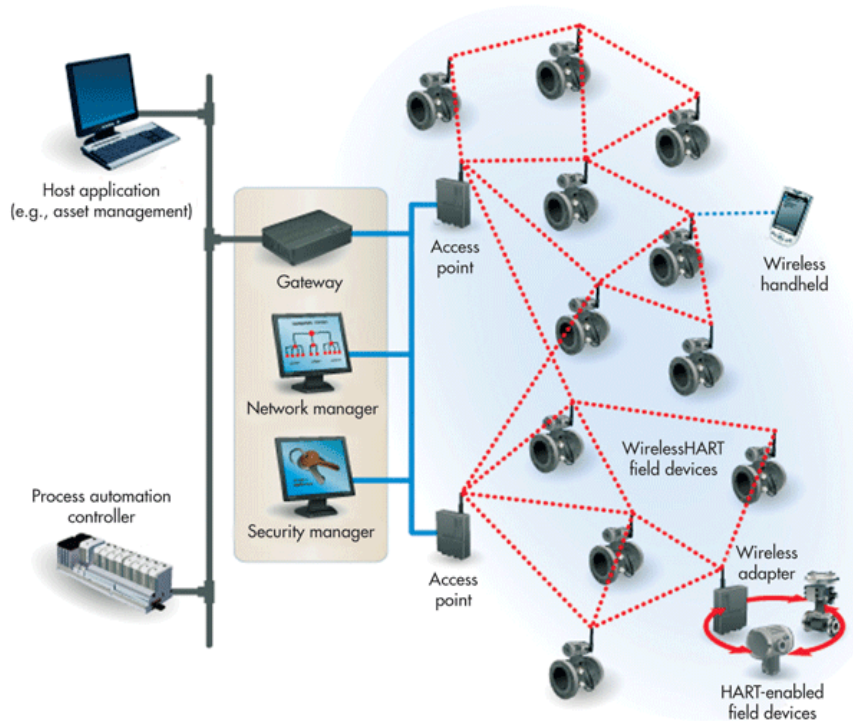

Figure 4: Industrial control application

2.3.3 Health Applications

Today, hospitals are increasingly seeking for applications for WSN technology in their own field containing pre-hospital and in-hospital emergency attention, stroke invalid rehabilitation and etc. WSNs can impact on the delivery and study of reviving medical care. They do so by collecting vital signs and incorporating them self-operatically in the

patient medical history to be utilized in real-time triage, in accordance with hospital histories and long-time view [5]. Figure 5 mention about some health and medical applications:

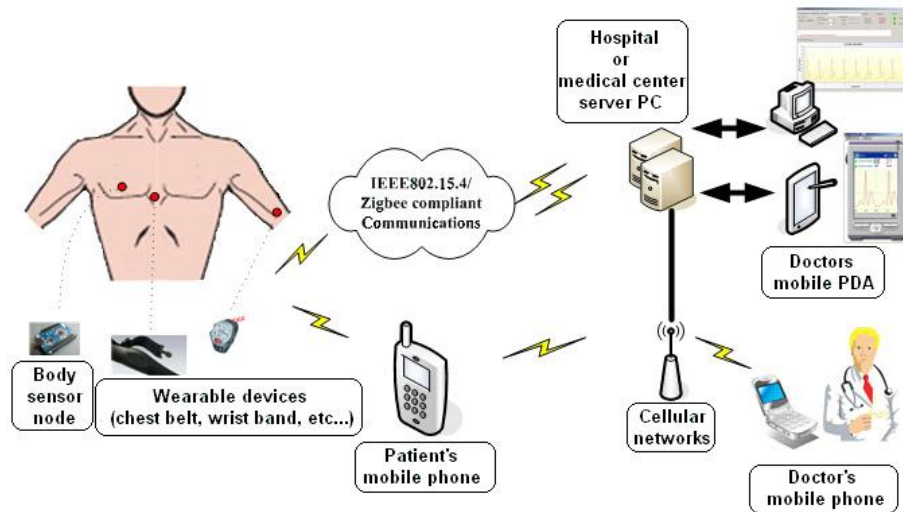

Figure 5 : Medical application

2.3.4 Environment Applications

When using wireless sensor networks in real environment, there are various benefits and disadvantages. The first advantage is that the need for power or data cables would be reduced. The major challenges are providing power and weather-proof facilities for long-term applications [5].

In warmer climates, the problems are to prevent the growth of bacteria and grasses. Another need is to work within a wide range of temperatures for outdoor devices. Sensor networks in outdoor situation primarily are used for measurement of weather and

environmental factors, and also the agricultural related fields. Figure 6 showed the sensor that put in nature for measuring the temperature.



Figure 6: Weather application [5]

2.4 Applications of WSNs in Manufacturing

WSNs may be employed usefully for uncommon cases detection or serial information collection in manufacturing applications. In rare cases detection, sensors are employed for detecting and classifying rare and random cases, like alarm and failure detection information because of great changes in machine and facility safety or operator actions. However, collecting data periodically is needed for operations like tracking down of the material flows, monitoring of equipment/for health process. This kind of automation decreases the workforce cost and human errors [1]. Figure 7 is showed the plant floor that wireless sensor put for sensing and cycle of finding problem by sensors until final report to engineer at home or office.

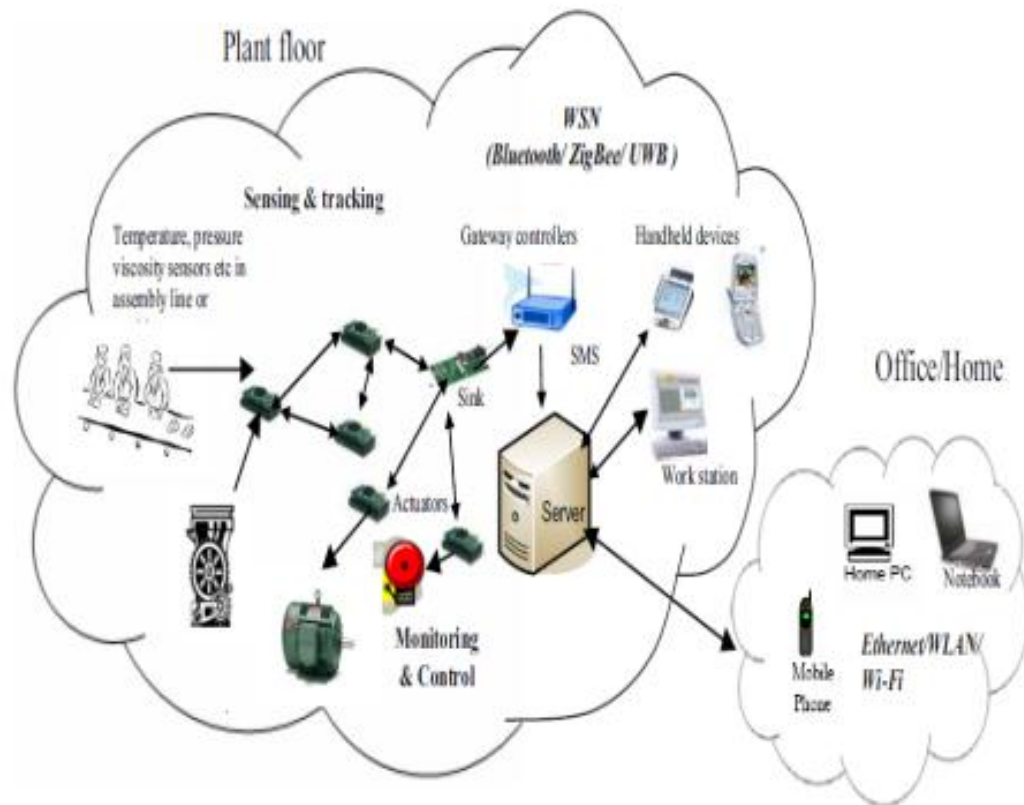

Figure 7: Industrial application [1]

2.4.1 Inventory Tracking

Inventory tracking systems are on the basis of manual processes which may result in sold-out, faster shipments, production laggings and billing delays circumstances. These kinds of WSN can control the quality of goods and products. For example, in general motors' tracking process is used, starting from the components suppliers until assembled cars and car dealers and customer [1]. Figure 8 show two different sensors that put in workshop for inventory tracking the product process.



Figure 8: Inventory tracking

2.4.2 In Process Part Tracking

WSN have duty of checking and managing the situation of machines and also the other WSNs. Mobile robots are the system that have calibrated sensors and they have duty to visit the field to collect data of sensors and decide if they need to recalibrated or not. As example, reading from the temperature sensors can be changed as season changed [7].

2.4.3 Monitoring

Monitoring allows us checking the health of machinery without need to cabling. Also it is possible to monitor the temperature, pressure, vibration and power. For example, the General Motors employs WSN technologies to control and monitor the manufacturing

tools like conveyer belts and the other kinds of instruments [7]. Figure 10 show the sensors for monitoring the product process.

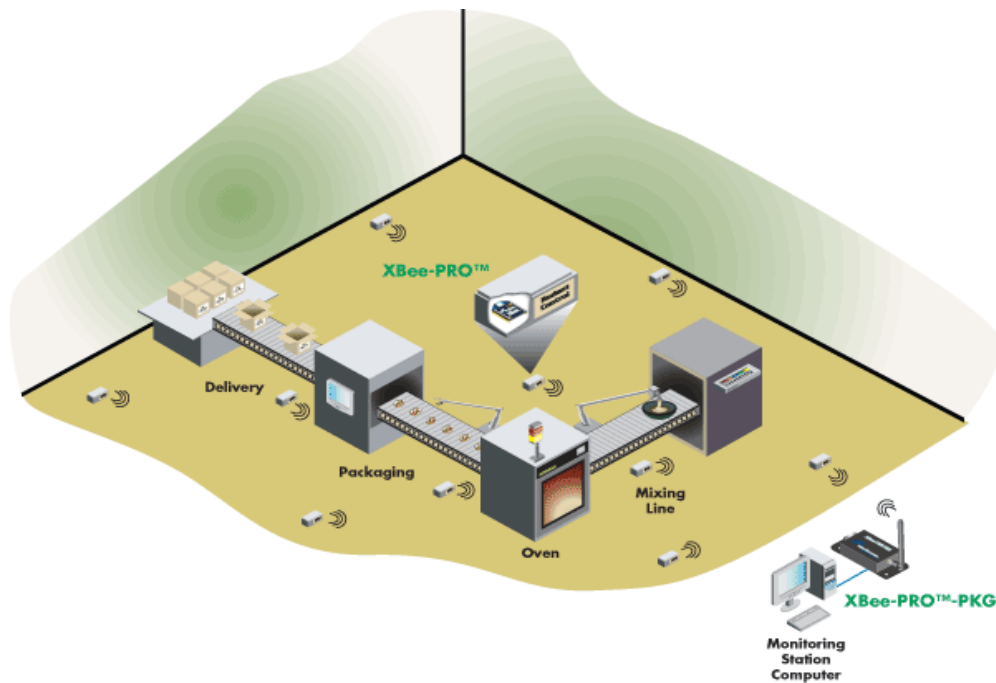

Figure 9: Monitoring

2.4.4 Environment Tracking

Wireless sensing is an effective approach to bring about solutions in the industry for some problems such as radiation check, climate reporting, leakage detection, intrusion notification, etc. Urgent warnings will send to operating directors to call for immediate preventive proceedings. Using WSNs, the occurrence of abnormalities like leakage of toxic compounds or presence of unauthorized personnel may be traced down through a plant [1].

Release of flammable liquids and gases like ammonia, chlorine in the petrochemical facilities may produce huge damage and risks for people, and free hazardous missions

into the air and environment. Now, many petroleum companies are conducting pilot tests for installing WSNs and planning to employ them broadly in near future [1].

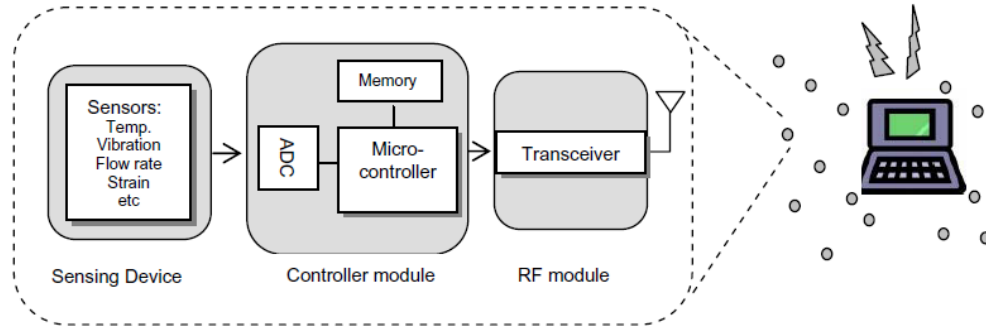

Figure 10: Condition monitoring of machine [1]

Chapter 3

LOCALIZATION OF WIRELESS SENSOR NETWORKS

3.1 WSNs Localization

Wireless sensor network (WSN) is a significant technology which has drawn considerable attention in research area. Recent developments in wireless communications and electronics field have provided an opportunity for developing low-cost, low-power and multi-functional sensors which have small size and can communicate in short range. Self-localization property is a highly significant capability of WSNs. In such cases as environmental monitoring like water quality monitoring, modern agriculture and fire alarming, it is of no use to evaluate data if you don't know from where this information are collected. In addition, knowing location may provide many applications like inventory management, surveillance, traffic monitoring, medical care monitoring, etc. To estimate the location of sensors in a network, it can be used a sensor network localization algorithm which in turn employs primarily unknown location information obtained by determining exact location of a few sensors and inter-sensor parameters like distance and bearing factors. Sensors with known location information are called beacons and their locations can be obtained by using a global positioning system (GPS), or by installing beacons at locations with known coordinates [8].

3.2 Main Phases of Localization Algorithms

The current WSN localization methods could be divided in lots of categories. Nonetheless, nearly all algorithms for WSN localization include three basic phases;

1) Distance estimation 2) position computation 3) localization algorithm [8].

3.2.1 Distance Estimation Techniques

Process of distance estimation greatly influences on precision. Interaction among two nodes provides a way to extract information concerning proximity characteristics and their geometric relationship. There are a variety of measuring methods which are used for determining the range among nodes in net. The four popular techniques for calculating span are: 1) AOA 2) TOA 3) TDOA 4) RSSI [3].

3.2.1.1 Angle of Arrival

The Angle of Arrival methods make it possible for each sensor estimating relative angles among received radio signals. This technique is highly accurate, and its major disadvantage is that they need to additional hardware [9].

3.2.1.2 Time of Arrival

The time of arrival method estimates distances among two nodes utility time measurement. The distances among nodes are directly proportional to the time a signals take to travel between nodes [10].

3.2.1.3 Time Different Of Arrival

Time different of arrival is a method for determining the distance between mobile stations and nearby synchronized base station [10].

3.2.1.4 Received Signal Strength Indicator

The Received Signal Strength Indicator (RSSI) is based on wireless connection. Visionary, the signal strength is reversely adequate to the squared distance among the transmitter and receiver. For converting received signal strength into distance, it is facile to use a known radio proliferation model. This technique is simple and cheap between span-based techniques of measurement, because this method does not need an extra hardware [10].

3.2.2 Measurement Techniques for Position Computation

There is too much method to calculate the coordinates of the unknown node based on span/junction data. Popular techniques are: 1) Angulation 2) Trilateration 3) Lateration [3].

3.2.2.1 Lateration and Trilateration

The position of unknown node can be calculated by Lateration method, according to the exact measurements of three non-collinear anchors. Spread to three dimension is not enough and it needs four anchors [3].

Lateration, displayed by the three anchors, is called Trilateration, also, if there are more than three anchors then it is called Multilateration [3].

3.2.2.2 Angulation and Triangulation

Angulation or Triangulation is widespread approach for position computation that instead of distances, it uses information concerning angles. This method is similar to Trilateration. In fact, based on the Angle of arrival, it is possible to derive the distances to the reference nodes [3].

3.2.3 Localization Algorithm

Matching to the ways of WSNs implementation, going localization algorithms classified into different categories like: 1) individual-hop and multi-hop localization 2) span-based and span-free 3) distributed and centralized situation calculation 4) beacon-based or beacon-free [3].

3.2.3.1 Individual-Hop and Multi-Hop Algorithms

A straight connection among two nodes has been named a hop. Single hop is kind of localization algorithm that use of only single hop radio information [11].

At the moment distance among two nodes be more than radio span while there will be others nodes that construct an ongoing route among them, the route has been called a multi-hop route. For example, in the situations like forest just possible to uses the multi-hop algorithm [11].

3.2.3.2 Span-Based and Span-Free Localization

The span-based near use span data like distance for measuring position. Span-free approaches do not require complete span data for distance or angle approximation but they employ amount of hops among a node couple as distance metric. The precision of span-free ways is shorter than span-based but span-free address the needs for lots of requests. Since WSN instruments have hardware limitations, instead of span-based approaches which are more expensive, it is better to use span-free localization methods as easy and economic answers. The main problem of this solution is that its efficacy is poor in irregular topologies [12].

3.2.3.3 Intensive and Divided Localization

In absolute kinds of WSNs, the architecture is reversely from the beginning because of the essence of difficulty the net is working with. Maximum part of the nets which are planned for controlling, are centralized because collected information is congregated into the one or lots of servers to be moved. The advantage of intensive solutions is their accuracy. In divided algorithms, it is usually tried to perform localization algorithm into every node then they could put themselves regarding their neighbors. In divided solutions errors are propagated and increased accumulatively because of the multi-hop implementation [13].

3.2.3.4 Beacon-Based and Beacon-Free Localization

Beacon-fixed algorithms depend on beacon nodes. They consider some nodes know their position either by handy form or utility some other positioning approaches (e.g., GPS). In beacon-free algorithms may employed local distance data to identify node coordinates [14].

Chapter 4

TRIANGULATION LOCALIZATION METHOD

Triangulating approach, which is considered the source of four strains, put a sensor in the triangular plan. With use of that we explain a method to derive a Cartesian coordinate's source in relation to the sensor array and the source's intensity [15]. In these methods, interference pattern made between three or more sensors is used. Also, to calculate the difference in number waves send to from a source to the two sensors, the time-delay technique among sensors with known position is used [16].

Disadvantages of this method are its dependence on a single or small span of frequencies that needs sensor sampling to beat intervals with wavelengths of integer numbers. This property usually limits interferometer arrays according to the size; as an example, in gamma ray observatories in which there is the question of wavelengths the physical manufacturing or implementation of the interposition are restricted. Filtering at definite frequencies (according a certain sampling frequency), we need extra calculation memory and processing procedure. In addition, if there are interferences which come from sources outside the sampling frequency, it will create deviations and untrue forecasts point source of phased arrays [17]. Anticipating the origin Cartesian coordinates in relation to the origin's severity and sensors is another advantage of this approach. The suggested method employs information concerning radioactive Energy transfer from the source as well as

the spherical model pickup unidirectional sensor, the method is triangulation. Therefore, we can develop a Beam-former according to the coordinates of the source which in turn can modify better acquisition and signal to noise ratio the source. The structure of a system composed of four unidirectional sensors placed in a plate that are identically spaced relative to a source (Figure 12). This approach will produce Cartesian coordinates of the source of the plane. Of course, it provides an estimation of the source's intrinsic energy [4].

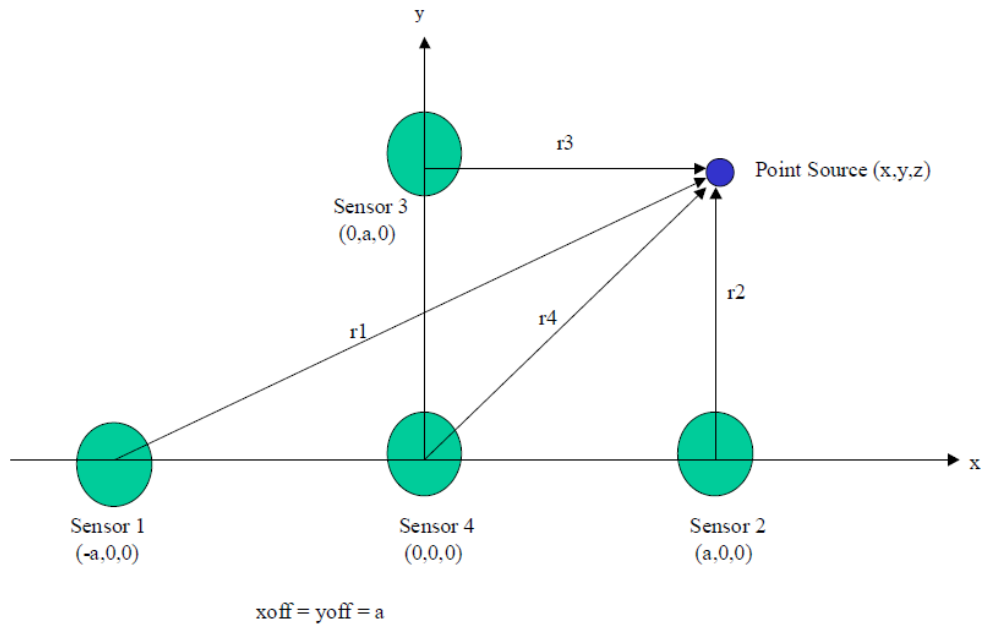

Figure 11: Sensor placement in the array [4]

By using formula below which is common equation of glittering transfer for point sources, we can track a single point source with the four unidirectional nodes in Figure 12:

$$RSSI = \frac{KI}{R^2} \quad (1)$$

Where RSSI is the RSSI field strength measured from each node, I stand for intensity of the transmitting source and r stands for distance of source to the node, k is permanent of symmetrically which is identical for each node. The connection in (1) was used to each of the four antennas in Figure 1 as follows:

$$\text{RSSI}_j = \frac{KI}{R_j^2} \quad j = 1, 2, 3, \dots \quad (2)$$

The radial distances from nodes to source are specified from Figure 12:

$$\begin{aligned} r_1^2 &= (x + x_{\text{off}})^2 + y^2 \\ r_2^2 &= (x - x_{\text{off}})^2 + y^2 \\ r_3^2 &= x^2 + (y - y_{\text{off}})^2 \\ r_4^2 &= x^2 + y^2 \end{aligned} \quad (3)$$

In the place that x_{off} or y_{off} is the offset of every node from axis of x or axis of y , relatively, and are considered to be equal and similar. Likewise (2), solutions to the source will supply a sphere of radius surrounding every node. With combine (2) and (3) permits for a simultaneous set of equations in the variables x, y :

$$\begin{aligned} ar_1^2 &= (x + x_{\text{off}})^2 + y^2 \\ br_1^2 &= (x - x_{\text{off}})^2 + y^2 \\ cr_1^2 &= x^2 + (y - y_{\text{off}})^2 \\ dr_1^2 &= x^2 + y^2 \end{aligned} \quad (4)$$

Where

$$\begin{pmatrix} a & b \\ c & d \end{pmatrix} = \begin{pmatrix} 1 & \dots & \frac{\text{RSSI}_1}{\text{RSSI}_2} \\ \vdots & \ddots & \vdots \\ \frac{\text{RSSI}_1}{\text{RSSI}_3} & \dots & \frac{\text{RSSI}_1}{\text{RSSI}_4} \end{pmatrix} \quad (5)$$

This is the permanent matrix that combines the proportion of calculated RSSI from every node with combining (2) and (3).

Attention that k from (2) scratch in the (5) along with origin severity I.

Simultaneous results for a variables x, y found by solve (4), (5)

(Assume that $x_{\text{off}} = y_{\text{off}} = e$):

$$x = \frac{e(b-1)}{2(b+1-2d)} \quad y = \frac{e(b+1-2c)}{2(b+1-2d)} \quad (6)$$

The (x,y) that is achieved from (6) can determine the position of unknown node or point source in plane.

Chapter 5

METHODOLOGY AND EXPERIMENTATION

5.1 First Experimental Method

The experimental part was done in the exterior space and without any equipment and mechanical tools. The experiment was done in the ground and in the very quiet place. The coordinate system that was used in this part was 2D and length of x and y was 10 meter [Table1].



Figure 12: First experimentation in the free space

Table 1: Measured RSSI for the experimental method[18]

	X-axis first (dbm)	X-axis first average (dbm)	X-axis second (dbm)	X-axis second average (dbm)	Y-axis first (dbm)	Y-axis first average (dbm)	Y-axis second (dbm)	Y-axis second average (dbm)	X-axis First & second average (dbm)	Y-axis first & second average (dbm)	Total average (dbm)
1 m	-41 to -42	-41.5	-45 to -46	-45.5	-35	-35	-37.5	-37.5	-43.5	-36.25	-40
2 m	-57 to -60	-58.5	-63 to -65	-64	-52 to -54	-53	-48 to -49	-48.5	-61.25	-50.75	-56
3 m	-59	-59	-61 to -64	-62.5	-57	-57	-56 to -57	-56.5	-60.75	-56.75	-59.25
4 m	-61 to -63	-62.5	-65 to -67	-66	-63.5	-63.5	-62	-62	-64.25	-62.75	-63.5
5 m	-64 to -65	-64.5	-62 to -66	-64	-70	-70	-63 to -65	-64	-64.25	-66.5	-65.7
6 m	-64 to -68	-66	-67 to -70	-68.5	-75	-75	-70 to -72	-71	-67.25	-74	-71.5
7 m	-74 to -76	-75	-75 to -79	-77	-68.5	-68.5	-67 to -68	-67.5	-76	-68	-72
8 m	-77 to -81	-79	-68 to -73	-70.5	-77 to -80	-78.5	-70 to -74	-72	-74.75	-75.25	-75
9 m	-79 to -80	-79.5	-73 to -76	-74.5	-73 to -76	-74.5	-71	-71	-77	-72.75	-75.25
10 m	-71 to -73	-72	-65 to -67	-66	-69 to -70	-69.5	-69 to -71	-70	-69	-69.75	-69.40

Table 1 show the result produced after first experiment. In this experiment the minimum and maximum RSSI were calculated for each meter and then its average was calculated. This calculation was repeated for all points from 1 to 10 meter; a couple of times for each meter which were conducted in two directions. The result has shown that the errors between the first and second time of measuring were too much. For example, in the first meter the average of first measuring in x direction was -41.5 dbm and the average of second measuring at the same point was -45.5 dbm.

5.2 Friss Equation

Friss transmission is the theoretical formula to achieve the RSSI based on distance.

$$\text{RSSI[dbm]} = -(10 \times n \times \log_{10}(D) + A) \quad (7)$$

D in this system is distance, n is coefficient of signal propagation and empirically its value is 3.25 and A is the absolute measured RSSI for 1 meter and empirically its value is 40.

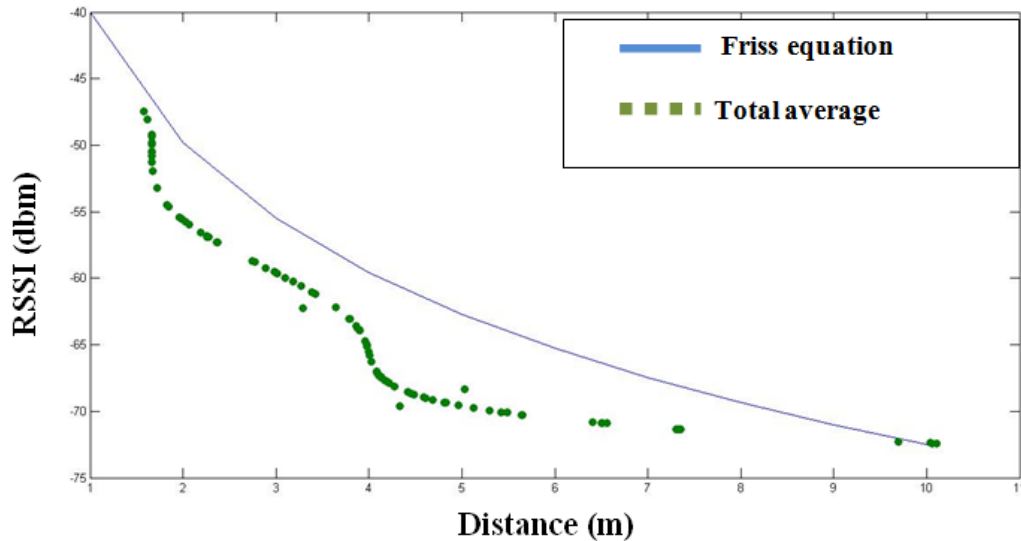

Figure 13: Comparison RSSI errors between first experiment and Friss equation

Figure 14 is produced by comparing errors between first experimental part and Friss equation and shows that errors in RSSI results after comparing this two method is too much. For example, where RSSI is -65 dbm, the distance resulted from first experiment is 4 meter, and that resulted from Friss equation is 6 meter.

Table 2 shows the comparing position (x,y) errors between first experimental environment and triangulation method. The results have been achieved from comparing position of more than 100 points where there are 400 random distances translated to RSSI using Friss equation. By putting this RSSI in triangulation formula, it could be achieved the positions x and y for more than 100 points. The comparison shows that the errors are

too much and the average error resulted by this comparison was 1.97 meter suggesting that maybe it is not possible to simulate triangulation method by RSSI and it is necessary to change the distance position algorithm. So, we have decided to check our method based on RSSI.

Table 2: Compared position of hundred random nodes by first experimental method and triangulation method

	First Experimental Environment			Triangulation Results		
	Random RSSI	Distance (m)	Position	Random RSSI	Distance (m)	Position
Node 1	-76.1953	14.3691	[3.5996,5.2052]	-76.1953	12.9928	[2.0728,5.4022]
	-70.7632	6.3198		-70.7632	8.8422	
	-51.2068	1.6701		-51.2068	2.321	
	-57.2739	2.7476		-57.2739	3.7652	
Node 2	-74.936	11.293	[0.5225,5.1258]	-74.936	11.8838	[0.9411,5.3034]
	-72.4406	10.2201		-72.4406	9.958	
	-51.2068	1.6654		-51.2068	2.2122	
	-57.2739	2.3592		-57.2739	3.4002	
Node 3	-78.0341	15.2703	[4.9577,3.3683]	-78.0341	14.8006	[4.7729,1.5929]
	-54.78	1.8676		-54.78	2.8495	
	-70.7824	6.3491		-70.7824	8.8542	
	-47.4937	1.58		-47.4937	1.7605	

5.3 Common Position Estimation

For checking the triangulation method based on RSSI, it was decided to compare method with radial distance formula that gives the exact position of unknown nodes that achieved from mathematical calculation.

$$r_1^2 = (x + x_{\text{off}})^2 + y^2 \quad r_2^2 = (x - x_{\text{off}})^2 + y^2$$

$$r_3^2 = x^2 + (y - y_{\text{off}})^2 \quad r_4^2 = x^2 + y^2$$

From this formula and with use of specified distances, it is possible to get the position (x,y) , so for achieving position of more than hundred point , have given the four hundred random distance (each point four distance). In this formula the offset of x and y is equal 10.

Table 3: Compared position of hundred random unknown nodes by common position estimation and triangulation method

Common Position Estimation			Triangulation Results		
	Distance (m)	Position	Random RSSI	Distance (m)	Position
Node 1	12.9928	[1.7995,5.4394]	-76.1953	12.9928	[2.0728,5.4022]
	8.8422		-70.7632	8.8422	
	2.321		-51.2068	2.321	
	3.7652		-57.2739	3.7652	
Node 2	11.8838	[0.6199,5.3333]	-74.936	11.8838	[0.9411,5.3034]
	9.958		-72.4406	9.958	
	2.2122		-51.2068	2.2122	
	3.4002		-57.2739	3.4002	
Node 3	14.8006	[4.7489,1.2366]	-78.0341	14.8006	[4.7729,1.5929]
	2.8495		-54.78	2.8495	
	8.8542		-70.7824	8.8542	
	1.7605		-47.4937	1.7605	

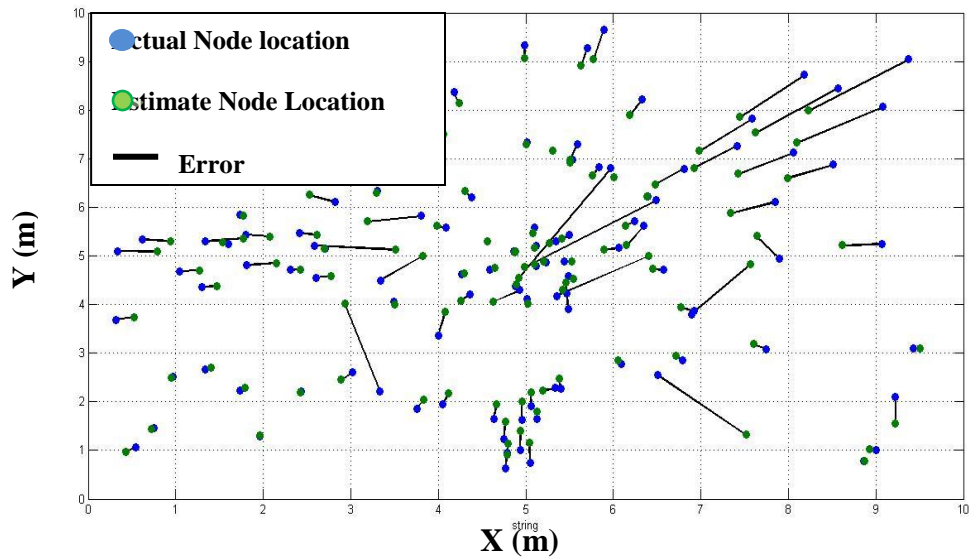

Figure 14: Error between triangulation method and common position estimation

Figure 15 shows the comparison of position errors between triangulation method and common position estimation and also the average error which is 0.4 meter meaning that it is possible to make simulation triangulation method based on RSSI (Table 3). But, it experiment environment should be changed because of many errors in first experimental environment which was our data source such as environmental conditions, position of people near sensors, tools around sensors and so on. So, we decided to change our location to the industrial environment.

5.4 Industrial Environment

The second practical part of thesis was implemented in the workshop department of mechanical engineering and this part can be as industrial application of thesis in the manufacturing field. The workshop have different types of manufacturing tools and machines like surface grinding, milling, lathe and drilling machine (Figure 15).

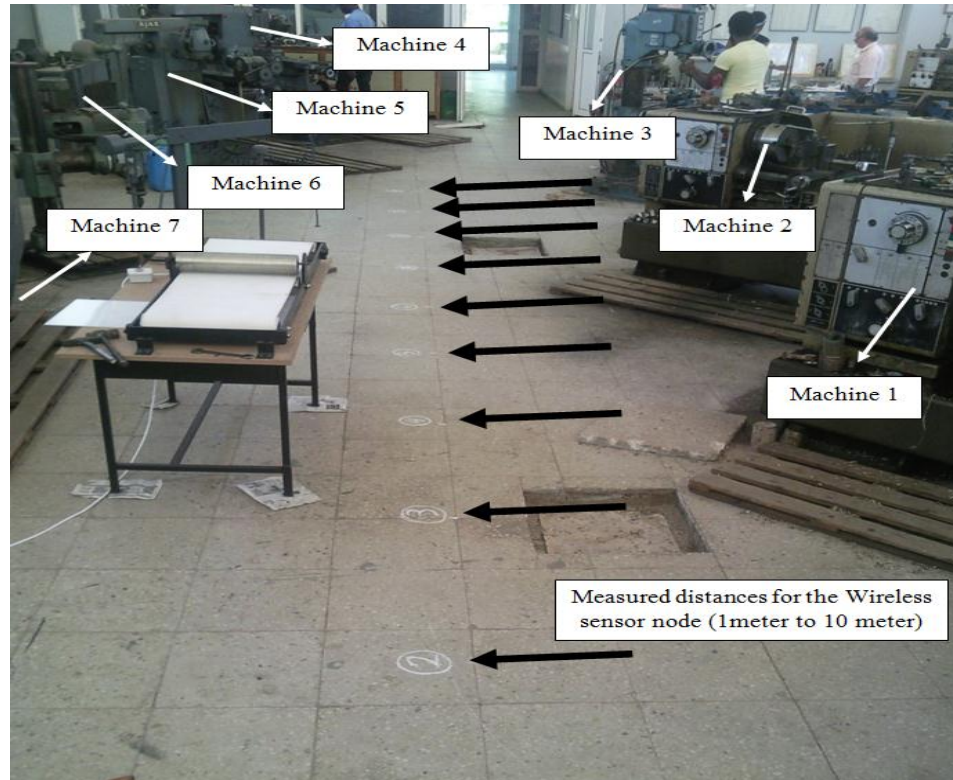

Figure 15: View of workshop after implementing the sensor nodes

Sensor nodes have performed among workshop machines but in this place opposite of the experimental part that was in quiet place have lots of machines with too much noise (Figure 16(a, b)).



ab

Figure 16(a, b): practical work in the workshop

Table 4: Measured RSSI in workshop of university

	First	Ave	Second	Ave	Third	Ave	Fourth	Ave	Fifth	Ave	Ave
1 m	-45 to -47	-46	-44 to -45	-45	-46 to -47	-46.5	-50	-50	-45 to -47	-46	46.7
2 m	-56	-56	-53 to -57	-55	-49 to -53	51	-57 to -59	-58	-54 to -58	-56	54.3
3 m	-54	-54	-55 to -56	-56	-48 to -51	-49.5	-48	-48	-51 to -54	-52.5	52
4 m	-60 to -62	-61	-60 to -62	61	-60 to -62	-61	-60	-60	-58 to -62	-60	60.6
5 m	-63	-63	-62	-62	-64 to -66	-65	-60	-60	-62 to -65	-63.5	62.7
6 m	-61	-61	-73	-73	-61 to -63	-62	-61 to -63	-62	-59 to -62	-60.5	63.7
7 m	-65 to -68	-66.5	-63 to -64	-64	-73 to -74	-73.5	-68 to -70	-69	-60 to -64	-62	67
8 m	-62 to -66	-64	-60 to -62	-61	-60 to -62	-61	-68 to -70	-69	-62 to -64	-63	63.6
9 m	-60	-60	-60 to -62	-61	-58 to -60	-59	-60 to -62	-61	-63 to -64	-63.5	60.9
10 m	-75 to -78	-76.5	-68 to -70	-69	-74 to -75	-74.5	-68 to -70	-69	-74 to -76	-75	72.8

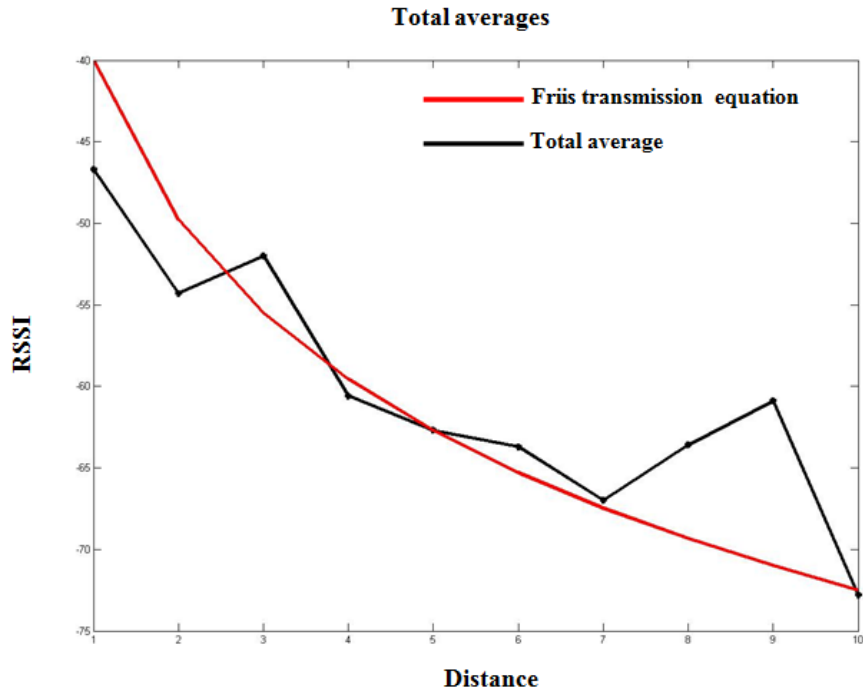

Figure 17: Total average between Friis equation and second experiment

In this experiment, each point was measured 5 times to get the results with more accuracy and with looking to the results can say that for example in meter 1 that measured 5 time, in four time the average results are too close together (Figure 17).

The results produced by comparing RSSI errors between second experimental environment and Friis equation show that the errors between these two comparisons are too small except in 3 points that is in distances 3,8 and 9 meter. The reason for occurrence of many errors in these three points is the proximity of mechanical machines to these points and people who were working in their neighborhood (Figure 18).

As for conclusion, it should be said that in first experimental environment the data source (e.g. environmental conditions, position of people near sensors, tools around sensors) was

responsible for most part of the errors. Also the simulation of triangulation method based on RSSI in industrial environment is executable.

5.5 Compared errors between three localization Methods

In Eastern Mediterranean University three master students worked on localization but in three different methods. One of them worked on Fuzzy Logic localization, the other worked on Trilateration localization and the last one was Triangulation localization.

The Fuzzy Logic(FL) method focus on what the system should do, not on the modeling of the system and also FL focus on the solving the problem. The Fuzzy Logic solution is a commentary of man-made result [19]. The Fuzzy Logic system is deduction system that includes fusilier, defuzzifier, fuzzy inference engine and some rules as shown as in Figure 21 [20].

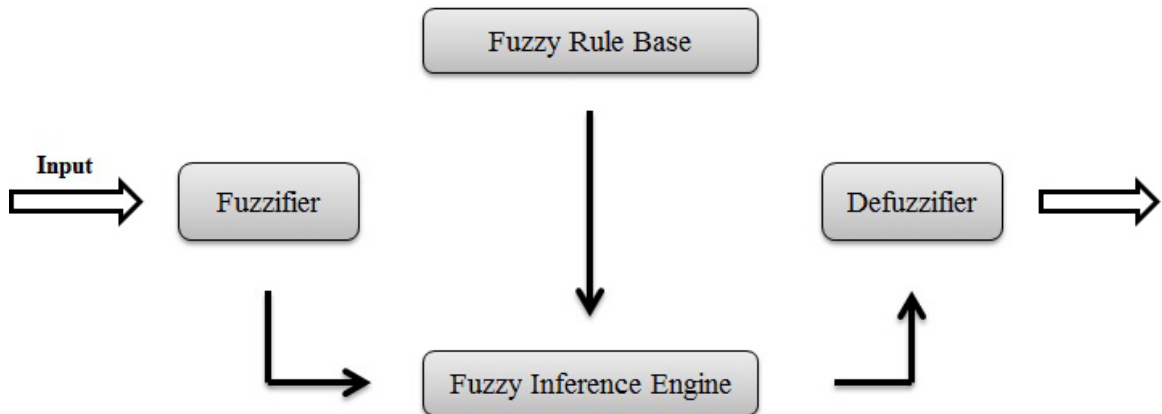

Figure 18: Fuzzy logic method [21]

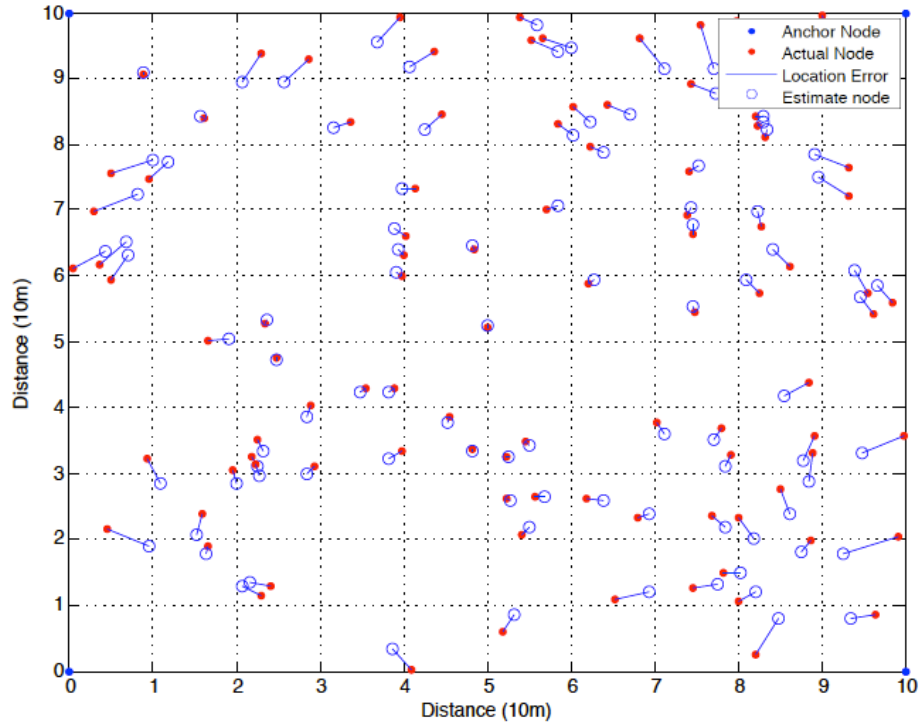

Figure 19: Simulation result of fuzzy logic method [21]

The Trilateration method is one of the famous methods for calculation the position of unknown nodes by utility of three known node location. The most important different between this method and Triangulation method is the formula that have used to get the unknown position.

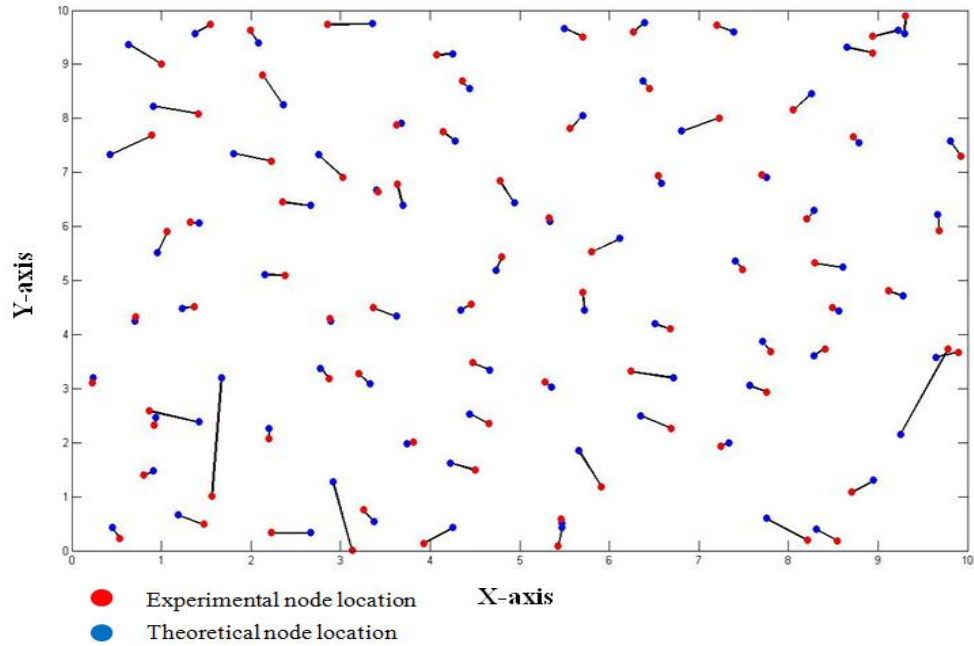

Figure 20: Simulation result of Trilateration method [18]

Table 5: Performance Comparison of the errors between three localization Methods

	Triangulation	Trilateration	Fuzzy Logic
Average Error	0.4093	0.4161	0.3952
Maximum Error	2.43	2.76	0.98

This result was achieving from each method separately and there is no general method to compare them carefully but with first glance we understand that the fuzzy logic has better result. It has two reasons, first in fuzzy method that was researched in our university there is no any industrial environment research on it. Also in this method the amount of sensors that was used is more so the amount of error will decrease (Table 5).

Chapter 6

CONCLUSION

The node location is still the most substantial topic in wireless sensor network and also is so vital for manufacturing systems because of effecting in monitoring, data processing, power consumption, inventory tracking and etc. The triangulation localization method has different phases and techniques to estimate the location of unknown nodes.

Theses centralized on the technique that using of received signal strength indicator and distance for estimating the sensor position. The present thesis has used of various equations such as Friss and Neville and software of Matlab as function. All experiments were done in 2D dimension and length of X and Y was 10 meter. In the final phase, the comparing has performed among three important localization method (Trilateration, Triangulation, and Fuzzy Logic) that were researched concerned them in the Eastern Mediterranean University to find the different error between them.

As a future work, the triangulation method based on received signal strength indicator has the ability to continue the experiments on it in 3D space, but it need special budget for implementation and more time for research. Furthermore, with increasing the number of beacon nodes, it is possible to estimating the location of sensors in order to decrease errors. Also I want to test my method in the other distance based methods and in the

methods that are not distance based. With trying different distance estimation methods in triangulation method it is possible to pick the best method for industrial environment.

REFERENCES

- [1] Soon Low Kay, Nu Nu Wi Win, and Joo Er Meng, "Wireless Sensor Networks for Industrial Environments," in *Proceedings of the 2005 International Conference on Computational Intelligence for Modelling, Control and Automation, and International Conference on*, 2005, p. 6.

- [2] Mao Guoqiang, Baris Fidan, and Brian D.O. Anderson, "Wireless sensor network localization techniques," in *Research School of Information Sciences and Engineering, The Australian National University, Sydney*, 2006, p. 25.

- [3] Mert Bal, Min Liu, Weiming Shen, and Hamada Ghenniwa, "Localization in Cooperative Wireless Sensor Networks: A Review," in *Computer Supported Cooperative Work in Design*, 2009, p. 6.

- [4] Michael Harney, "A Method Of Triangulating," *Apeiron*, vol. 13, p. 6, october 2006.

- [5] David J Nagel, "Wireless Sensor Systems and Networks:Technologies, Applications, Implications," , 2007, p. 110.

- [6] Khazem Shorabi, Daniel Minoli, and Taieb Znati, "Wireless Sensor Networks

Technology, Protocols and Applications," , New Jersey., 2007, p. 300.

[7] J Hochmuth, "Case Study:GM cuts the cords to cut the costs," , 2005, p. 20.

[8] N Patwari, "Locating the nodes: Cooperative Localization in wireless sensor networks," vol. 22, p. 54, July 2005.

[9] P Rong, "Angle of arrival Localization," vol. 1, p. 374, September 2006.

[10] F Franceschini, M Galetto, D Maisano, and L Mastrogiacomo, "A review of localization algorithms for distributed wireless sensor networks in manufacturing," , Torino, 2009, p. 18.

[11] Whitehouse Kamin and Chris Karlof, "Single-Hop Localization," vol. 11, p. 41, January 2007.

[12] He Tian and Huang Du Cheng, "Range-Free vs Range-Based Localization," , New York, 2003, p. 8.

[13] Lin Sun Gun, "Distributed localization Algorithm," vol. 1, p. 536, March 2004.

[14] Xun Xue I Cu and Zhiguan Shan, "Anchor-Free Sensor Networks," vol. 19, p. 405, July 2008.

- [15] I M Skolnik and D D King, "Self-phasing array antennas," , 1964, p. 10.
- [16] Palit Sabarni, "Binary and Ternary Architectures For a Two-Channel 5-Bit Optical Receive Beamformer"., " , 2002, p. 12.
- [17] J R Harp, "Using Multiple Beams To Distinguish Radio Frequency Interference from SETI Signals," in *Workshop on Mitigation of Radio Frequency Interference in Radio Astronomy*, Penticton, July 2004, p. 8.
- [18] Poorya Ghafoorpoor, "Localization Trilateration of Wireless Sensor Networks for Industrial Applications," , 2012, p. 5.
- [19] M Hellmann, "Classification of fully polarimetric SAR for Cartographic Applications," , DLR Forschungsbericht, 2000, p. 12.
- [20] E H Mamdani, "Applications of fuzzy logic to approximate reasoning using linguistic synthesis," *Transactions on Computers*, vol. 26, p. 7, November 1971.
- [21] Mostafa Arbabi Monfared, "Localization in Wireless Sensor Networks Based on Fuzzy Logic," , Famagusta, 2012, p. 50.